

IRF7343QPBF

HEXFET® Power MOSFET

- Advanced Process Technology
- Ultra Low On-Resistance
- Dual N and P Channel MOSFET
- Surface Mount
- Available in Tape & Reel
- 150°C Operating Temperature
- Lead-Free

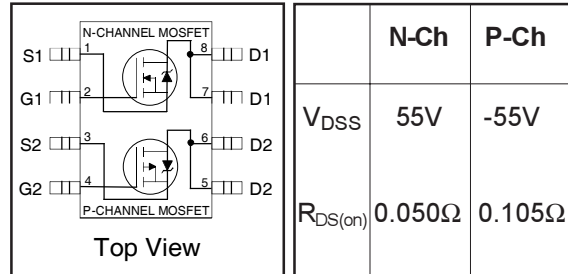

Description

These HEXFET® Power MOSFET's in a Dual SO-8 package utilize the latest processing techniques to achieve extremely low on-resistance per silicon area. Additional features of these HEXFET Power MOSFET's are a 150°C junction operating temperature, fast switching speed and improved repetitive avalanche rating. These benefits combine to make this design an extremely efficient and reliable device for use in a wide variety of applications.

The efficient SO-8 package provides enhanced thermal characteristics and dual MOSFET die capability making it ideal in a variety of power applications. This dual, surface mount SO-8 can dramatically reduce board space and is also available in Tape & Reel.

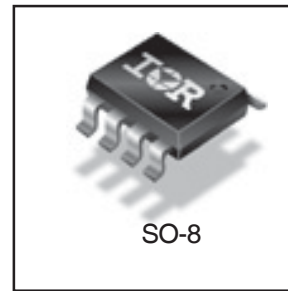

Absolute Maximum Ratings

Parameter	Description	Max.		Units
		N-Channel	P-Channel	
V_{DS}	Drain-Source Voltage	55	-55	V
$I_D @ T_A = 25^\circ\text{C}$	Continuous Drain Current, $V_{GS} @ 10\text{V}$	4.7	-3.4	A
$I_D @ T_A = 70^\circ\text{C}$	Continuous Drain Current, $V_{GS} @ 10\text{V}$	3.8	-2.7	
I_{DM}	Pulsed Drain Current ①	38	-27	
$P_D @ T_A = 25^\circ\text{C}$	Maximum Power Dissipation ⑤	2.0		W
$P_D @ T_A = 70^\circ\text{C}$	Maximum Power Dissipation ⑤	1.3		W
E_{AS}	Single Pulse Avalanche Energy ③	72	114	mJ
I_{AR}	Avalanche Current	4.7	-3.4	A
E_{AR}	Repetitive Avalanche Energy	0.20		mJ
V_{GS}	Gate-to-Source Voltage	± 20		V
dv/dt	Peak Diode Recovery dv/dt ②	5.0	-5.0	V/ns
T_J, T_{STG}	Junction and Storage Temperature Range	-55 to +150		°C

Thermal Resistance

Parameter	Description	Typ.	Max.	Units
$R_{\theta JA}$	Maximum Junction-to-Ambient ⑤	—	62.5	°C/W

IRF7343QPbF

International
IR Rectifier

Electrical Characteristics @ T_J = 25°C (unless otherwise specified)

Parameter	Description		Min.	Typ.	Max.	Units	Conditions
V _{(BR)DSS}	Drain-to-Source Breakdown Voltage	N-Ch	55	—	—	V	V _{GS} = 0V, I _D = 250μA
		P-Ch	-55	—	—		V _{GS} = 0V, I _D = -250μA
ΔV _{(BR)DSS} /ΔT _J	Breakdown Voltage Temp. Coefficient	N-Ch	—	0.059	—	V/°C	Reference to 25°C, I _D = 1mA
		P-Ch	—	0.054	—		Reference to 25°C, I _D = -1mA
R _{DS(ON)}	Static Drain-to-Source On-Resistance	N-Ch	—	0.043	0.050	Ω	V _{GS} = 10V, I _D = 4.7A ④
			—	0.056	0.065		V _{GS} = 4.5V, I _D = 3.8A ④
		P-Ch	—	0.095	0.105		V _{GS} = -10V, I _D = -3.4A ④
			—	0.150	0.170		V _{GS} = -4.5V, I _D = -2.7A ④
V _{GS(th)}	Gate Threshold Voltage	N-Ch	1.0	—	—	V	V _{DS} = V _{GS} , I _D = 250μA
		P-Ch	-1.0	—	—		V _{DS} = V _{GS} , I _D = -250μA
g _{fs}	Forward Transconductance	N-Ch	7.9	—	—	S	V _{DS} = 10V, I _D = 4.5A ④
		P-Ch	3.3	—	—		V _{DS} = -10V, I _D = -3.1A ④
I _{DSS}	Drain-to-Source Leakage Current	N-Ch	—	—	2.0	μA	V _{DS} = 55V, V _{GS} = 0V
		P-Ch	—	—	-2.0		V _{DS} = -55V, V _{GS} = 0V
		N-Ch	—	—	25		V _{DS} = 55V, V _{GS} = 0V, T _J = 55°C
		P-Ch	—	—	-25		V _{DS} = -55V, V _{GS} = 0V, T _J = 55°C
I _{GSS}	Gate-to-Source Forward Leakage	N-P	—	—	±100	nA	V _{GS} = ±20V
Q _g	Total Gate Charge	N-Ch	—	24	36	nC	N-Channel
		P-Ch	—	26	38		I _D = 4.5A, V _{DS} = 44V, V _{GS} = 10V ④
Q _{gs}	Gate-to-Source Charge	N-Ch	—	2.3	3.4		
		P-Ch	—	3.0	4.5		
Q _{gd}	Gate-to-Drain ("Miller") Charge	N-Ch	—	7.0	10		P-Channel
		P-Ch	—	8.4	13		I _D = -3.1A, V _{DS} = -44V, V _{GS} = -10V ④
t _{d(on)}	Turn-On Delay Time	N-Ch	—	8.3	12	ns	N-Channel
		P-Ch	—	14	22		V _{DD} = 28V, I _D = 1.0A, R _G = 6.0Ω, R _D = 28Ω ④
t _r	Rise Time	N-Ch	—	3.2	4.8		
		P-Ch	—	10	15		
t _{d(off)}	Turn-Off Delay Time	N-Ch	—	32	48		P-Channel
		P-Ch	—	43	64		V _{DD} = -28V, I _D = -1.0A, R _G = 6.0Ω, R _D = 28Ω ④
t _f	Fall Time	N-Ch	—	13	20		
		P-Ch	—	22	32		
C _{iss}	Input Capacitance	N-Ch	—	740	—	pF	N-Channel
		P-Ch	—	690	—		V _{GS} = 0V, V _{DS} = 25V, f = 1.0MHz
C _{oss}	Output Capacitance	N-Ch	—	190	—		P-Channel
		P-Ch	—	210	—		V _{GS} = 0V, V _{DS} = -25V, f = 1.0MHz
C _{rss}	Reverse Transfer Capacitance	N-Ch	—	71	—		
		P-Ch	—	86	—		

Source-Drain Ratings and Characteristics

Parameter	Description		Min.	Typ.	Max.	Units	Conditions
I _S	Continuous Source Current (Body Diode)	N-Ch	—	—	2.0	A	
		P-Ch	—	—	-2.0		
I _{SM}	Pulsed Source Current (Body Diode) ①	N-Ch	—	—	38		
		P-Ch	—	—	-27		
V _{SD}	Diode Forward Voltage	N-Ch	—	0.70	1.2	V	T _J = 25°C, I _S = 2.0A, V _{GS} = 0V ③
		P-Ch	—	-0.80	-1.2		T _J = 25°C, I _S = -2.0A, V _{GS} = 0V ③
t _{rr}	Reverse Recovery Time	N-Ch	—	60	90	ns	N-Channel
		P-Ch	—	54	80		T _J = 25°C, I _F = 2.0A, di/dt = 100A/μs ④
Q _{rr}	Reverse Recovery Charge	N-Ch	—	120	170	nC	P-Channel
		P-Ch	—	85	130		T _J = 25°C, I _F = -2.0A, di/dt = 100A/μs ④

Notes:

- ① Repetitive rating; pulse width limited by max. junction temperature. (See fig. 22)
- ② N-Channel I_{SD} ≤ 4.7A, di/dt ≤ 220A/μs, V_{DD} ≤ V_{(BR)DSS}, T_J ≤ 150°C
P-Channel I_{SD} ≤ -3.4A, di/dt ≤ -150A/μs, V_{DD} ≤ V_{(BR)DSS}, T_J ≤ 150°C
- ③ N-Channel Starting T_J = 25°C, L = 6.5mH R_G = 25Ω, I_{AS} = 4.7A.
P-Channel Starting T_J = 25°C, L = 20mH R_G = 25Ω, I_{AS} = -3.4A.
- ④ Pulse width ≤ 300μs; duty cycle ≤ 2%.
- ⑤ Surface mounted on FR-4 board, t ≤ 10sec.

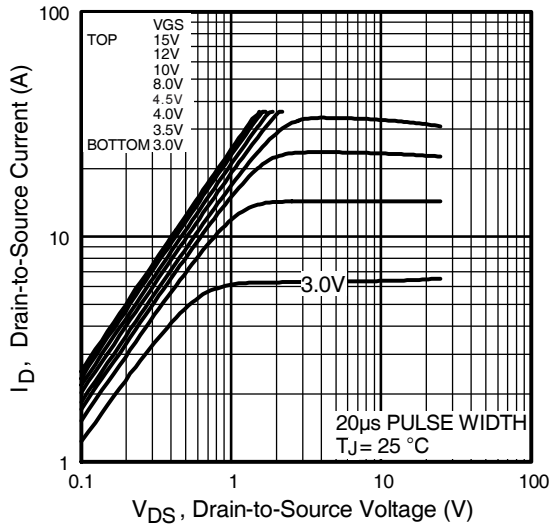

Fig 1. Typical Output Characteristics

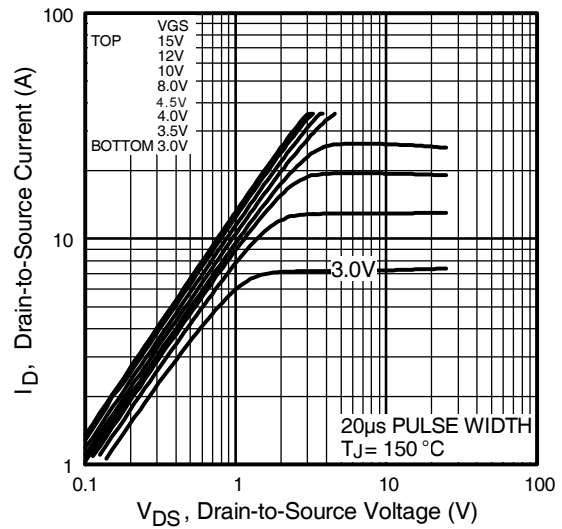

Fig 2. Typical Output Characteristics

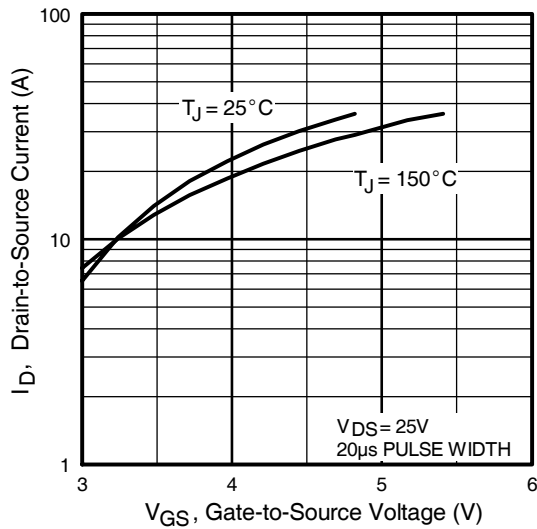

Fig 3. Typical Transfer Characteristics

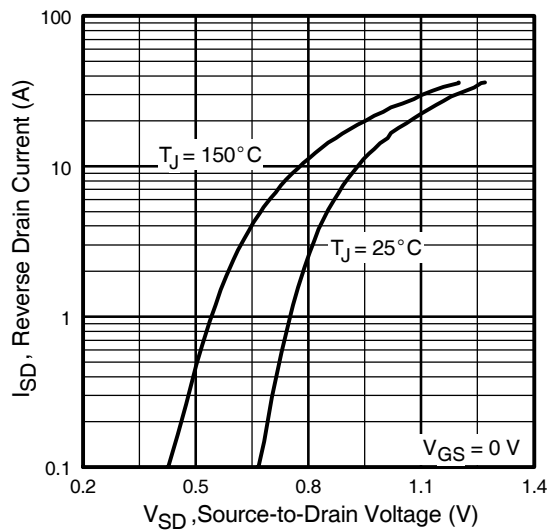

Fig 4. Typical Source-Drain Diode Forward Voltage

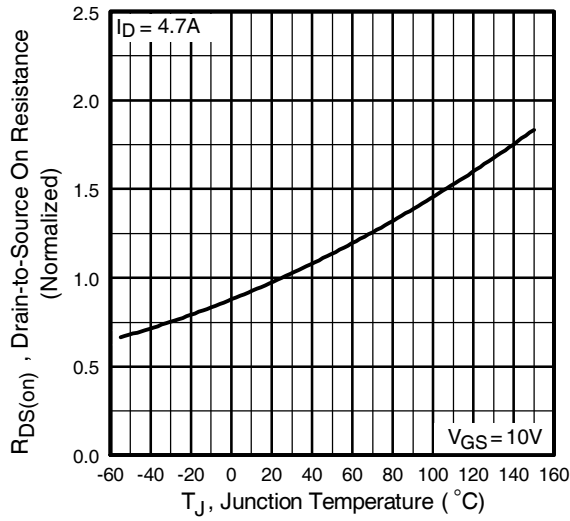

Fig 5. Normalized On-Resistance Vs. Temperature

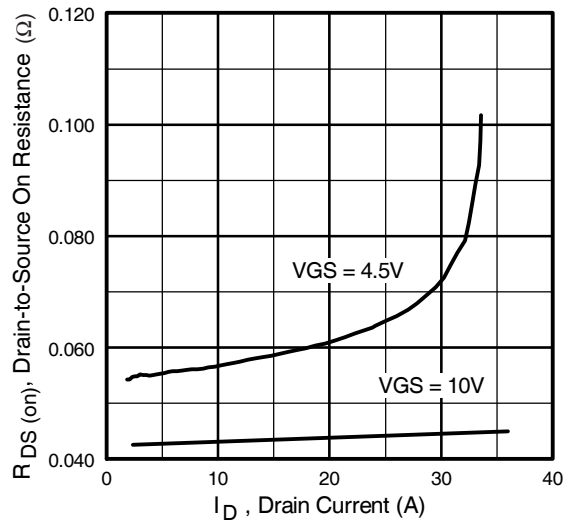

Fig 6. Typical On-Resistance Vs. Drain Current

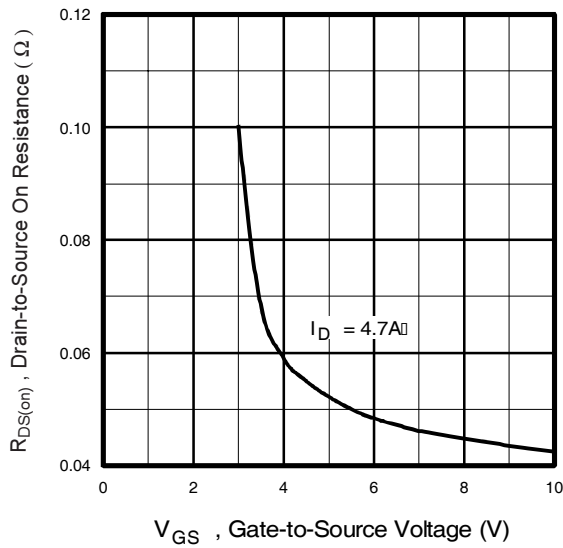

Fig 7. Typical On-Resistance Vs. Gate Voltage

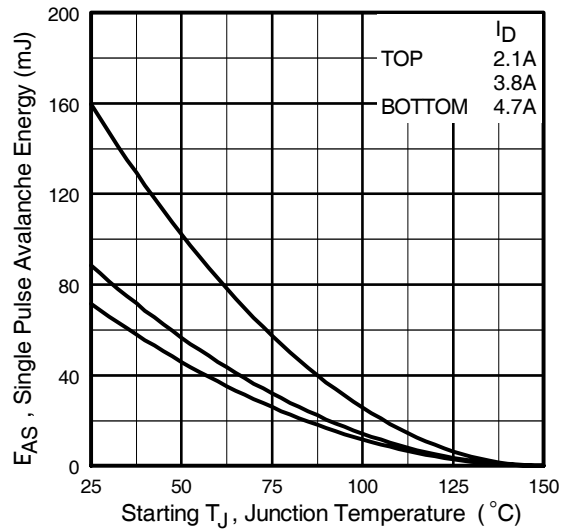

Fig 8. Maximum Avalanche Energy Vs. Drain Current

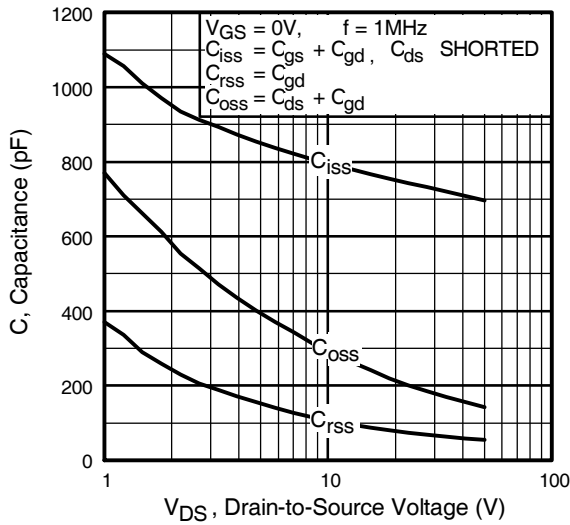

Fig 9. Typical Capacitance Vs. Drain-to-Source Voltage

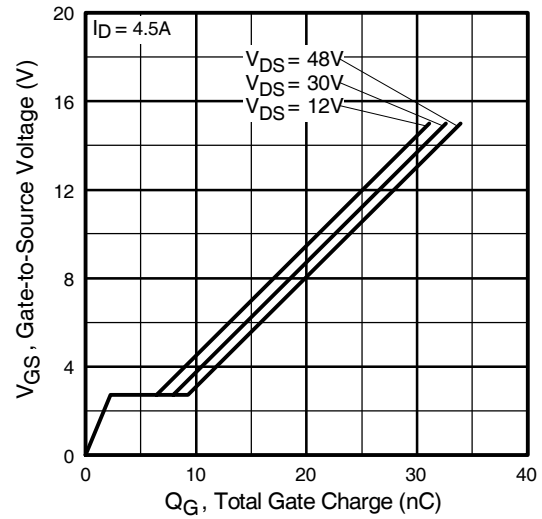

Fig 10. Typical Gate Charge Vs. Gate-to-Source Voltage

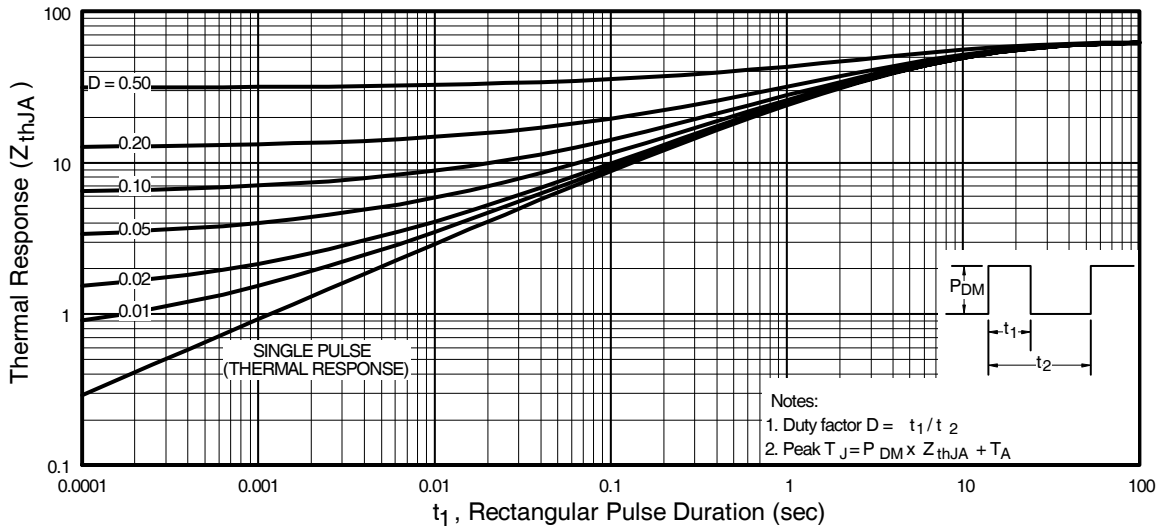

Fig 11. Maximum Effective Transient Thermal Impedance, Junction-to-Ambient

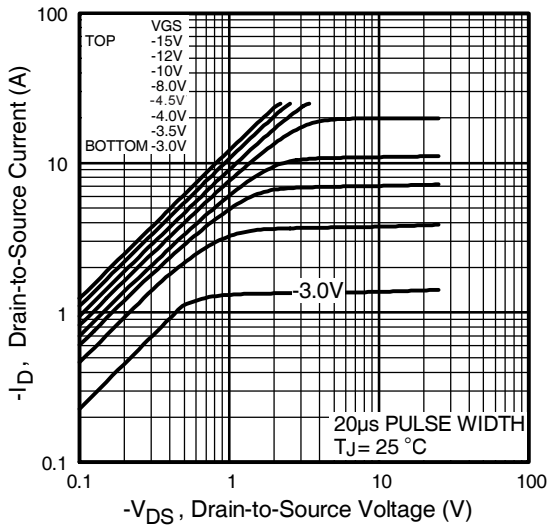

Fig 12. Typical Output Characteristics

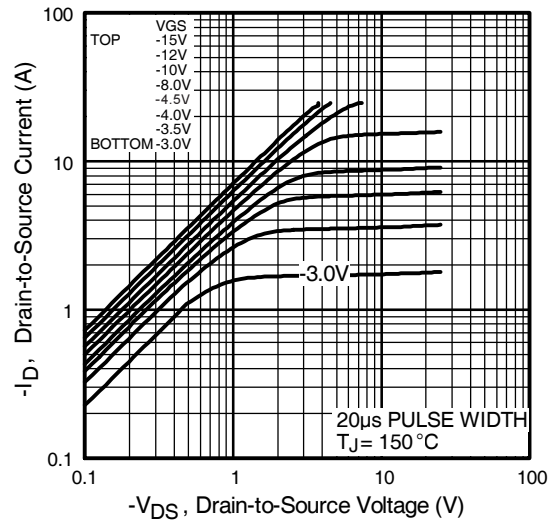

Fig 13. Typical Output Characteristics

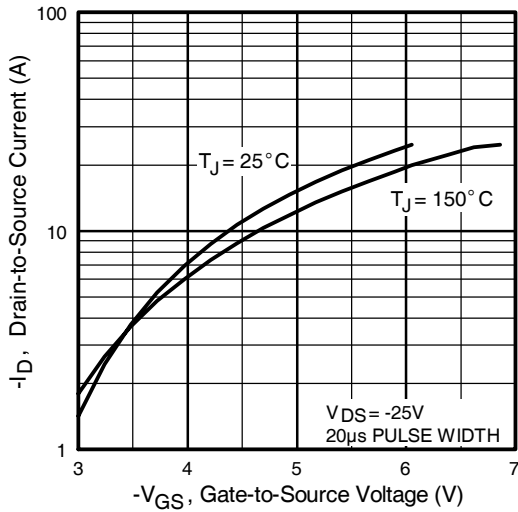

Fig 14. Typical Transfer Characteristics

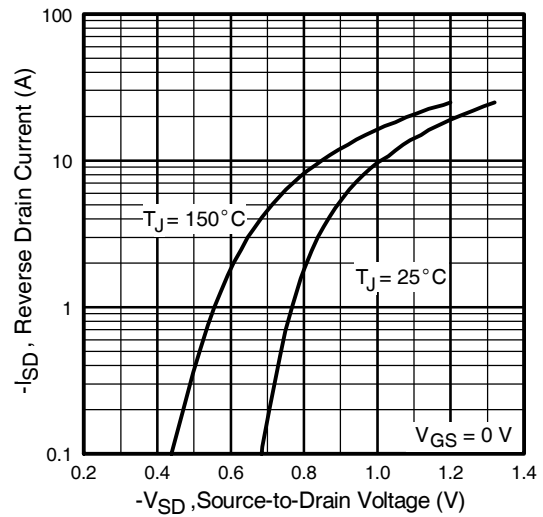

Fig 15. Typical Source-Drain Diode Forward Voltage

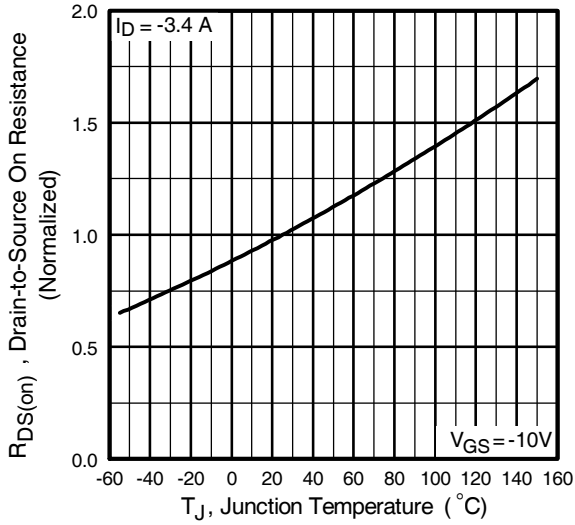

Fig 16. Normalized On-Resistance Vs. Temperature

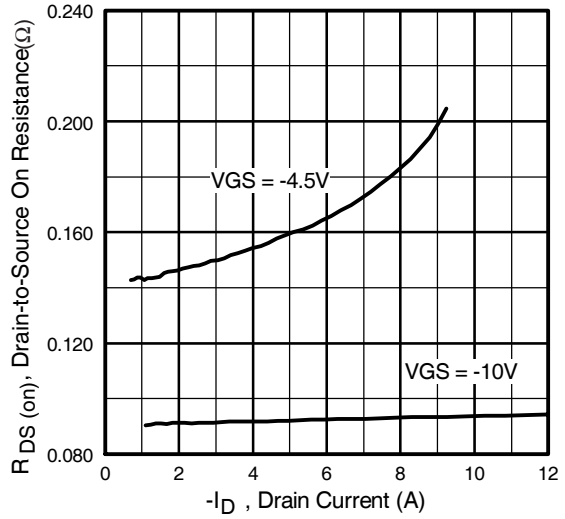

Fig 17. Typical On-Resistance Vs. Drain Current

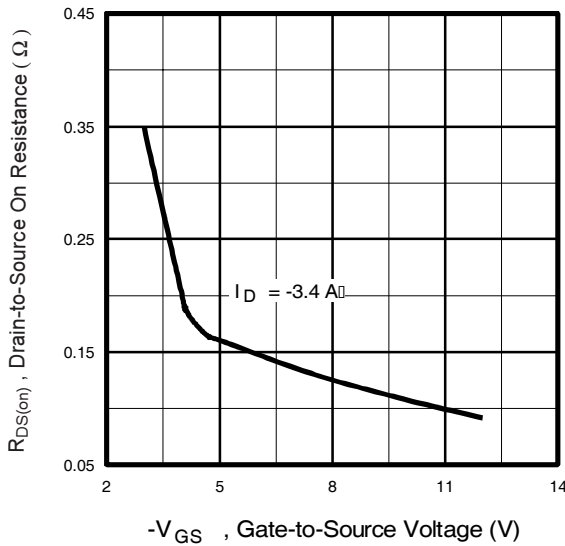

Fig 18. Typical On-Resistance Vs. Gate Voltage

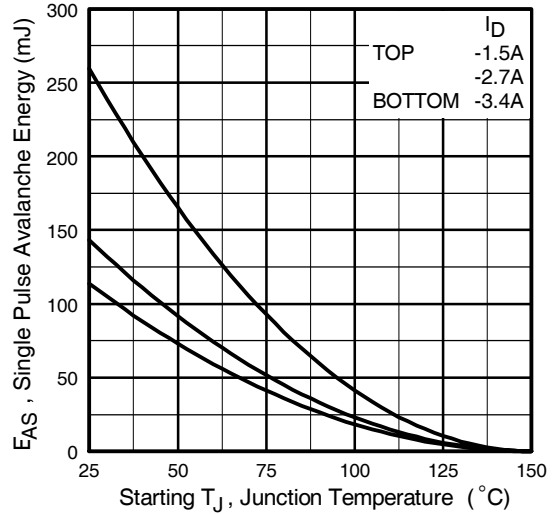

Fig 19. Maximum Avalanche Energy Vs. Drain Current

IRF7343QPbF

P-Channel

International
IR Rectifier

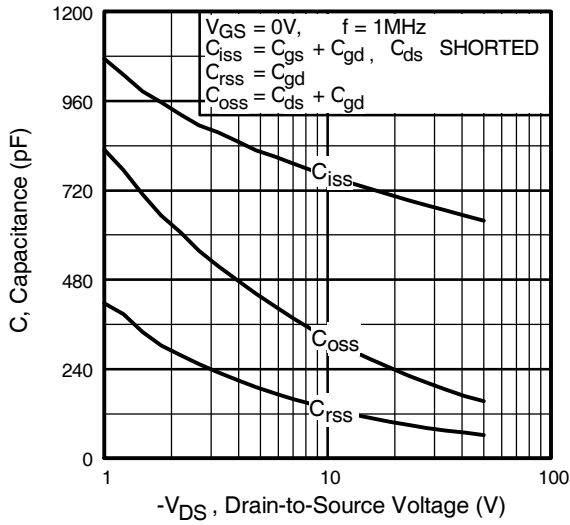

Fig 20. Typical Capacitance Vs. Drain-to-Source Voltage

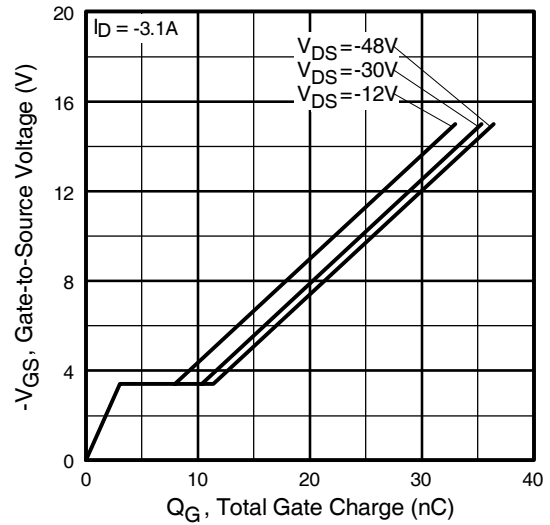

Fig 21. Typical Gate Charge Vs. Gate-to-Source Voltage

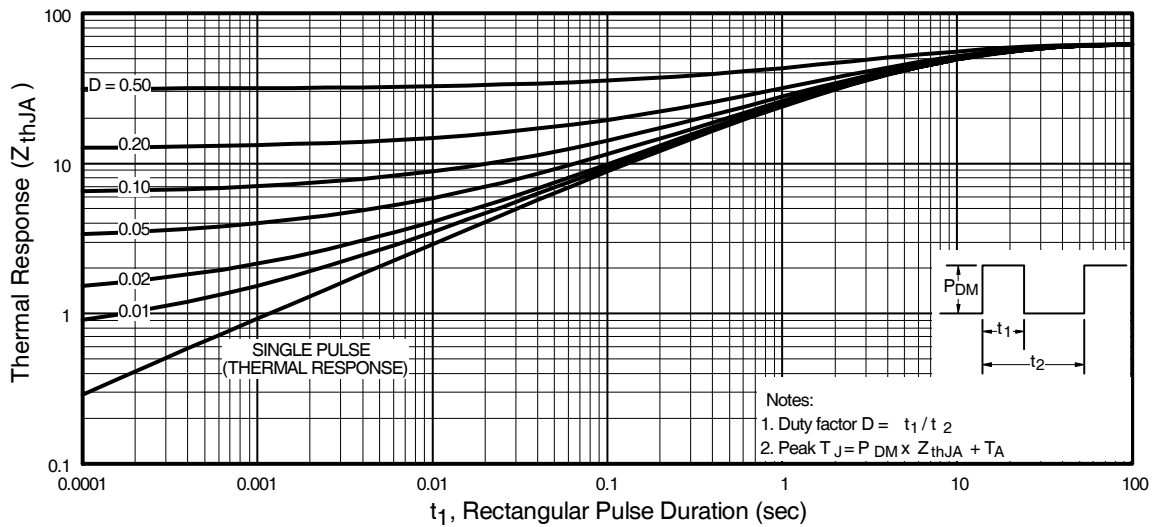
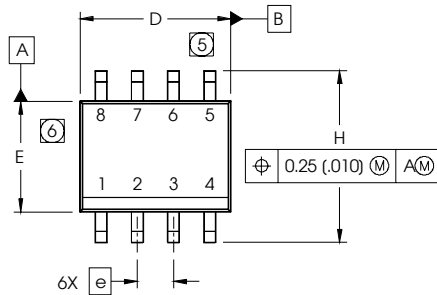

Fig 22. Maximum Effective Transient Thermal Impedance, Junction-to-Ambient

SO-8 Package Outline

Dimensions are shown in millimeters (inches)



DIM	INCHES		MILLIMETERS	
	MIN	MAX	MIN	MAX
A	.0532	.0688	1.35	1.75
A1	.0040	.0098	0.10	0.25
b	.013	.020	0.33	0.51
c	.0075	.0098	0.19	0.25
D	.189	.1968	4.80	5.00
E	.1497	.1574	3.80	4.00
e	.050 BASIC		1.27 BASIC	
e1	.025 BASIC		0.635 BASIC	
H	.2284	.2440	5.80	6.20
K	.0099	.0196	0.25	0.50
L	.016	.050	0.40	1.27
y	0°	8°	0°	8°

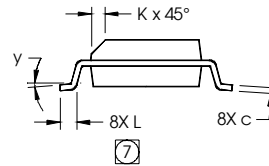
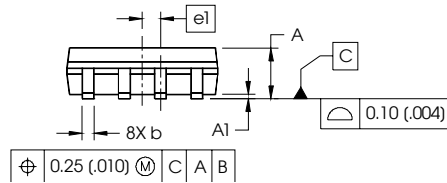

NOTES:

1. DIMENSIONING & TOLERANCING PER ASME Y14.5M-1994.
2. CONTROLLING DIMENSION: MILLIMETER
3. DIMENSIONS ARE SHOWN IN MILLIMETERS (INCHES).
4. OUTLINE CONFORMS TO JEDEC OUTLINE MS-012AA.
- ⑤ DIMENSION DOES NOT INCLUDE MOLD PROTRUSIONS. MOLD PROTRUSIONS NOT TO EXCEED 0.15 (.006).
- ⑥ DIMENSION DOES NOT INCLUDE MOLD PROTRUSIONS. MOLD PROTRUSIONS NOT TO EXCEED 0.25 (.010).
- ⑦ DIMENSION IS THE LENGTH OF LEAD FOR SOLDERING TO A SUBSTRATE.

FOOTPRINT

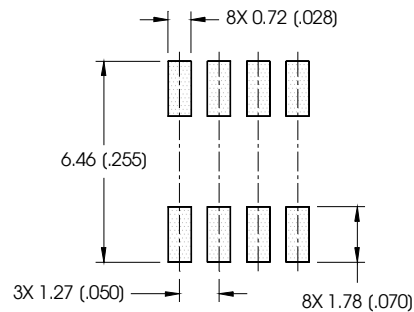

SO-8 Part Marking

EXAMPLE: THIS IS AN IRF7101 (MOSFET)

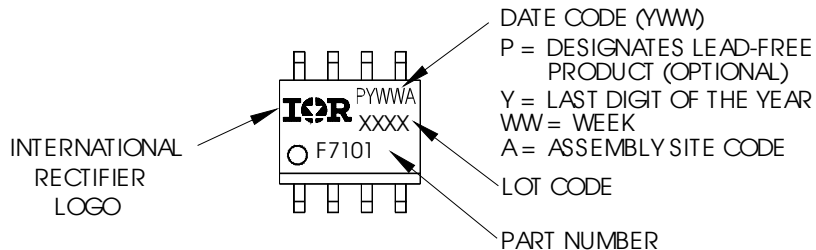

Notes:

1. For an Automotive Qualified version of this part please see <http://www.irf.com/product-info/auto/>
2. For the most current drawing please refer to IR website at <http://www.irf.com/package/>

IRF7343QPbF

International
IR Rectifier

SO-8 Tape and Reel

Dimensions are shown in millimeters (inches)

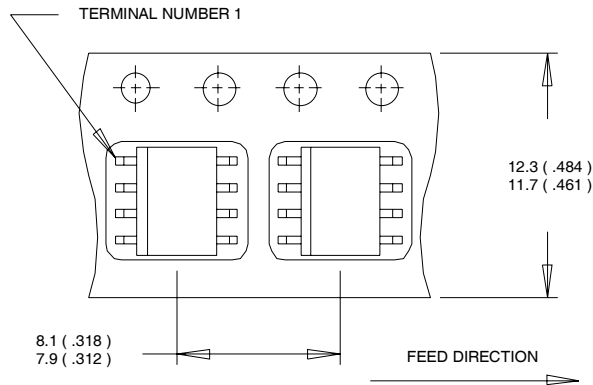

NOTES:

1. CONTROLLING DIMENSION : MILLIMETER.
2. ALL DIMENSIONS ARE SHOWN IN MILLIMETERS(INCHES).
3. OUTLINE CONFORMS TO EIA-481 & EIA-541.

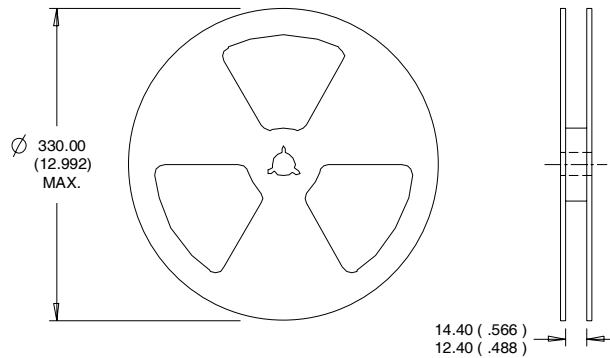

NOTES :

1. CONTROLLING DIMENSION : MILLIMETER.
2. OUTLINE CONFORMS TO EIA-481 & EIA-541.

Data and specifications subject to change without notice.
This product has been designed and qualified for the Industrial market.
Qualification Standards can be found on IR's Web site.

International
IR Rectifier

IR WORLD HEADQUARTERS: 233 Kansas St., El Segundo, California 90245, USA Tel: (310) 252-7105
TAC Fax: (310) 252-7903

Visit us at www.irf.com for sales contact information.08/2010

单击下面可查看定价，库存，交付和生命周期等信息

[>>Infineon Technologies\(英飞凌\)](#)