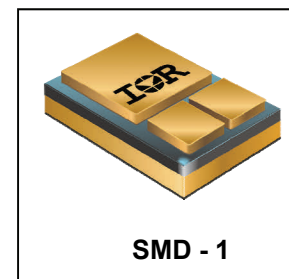


**RADIATION HARDENED**  
**POWER MOSFET**  
**SURFACE MOUNT (SMD-1)**

**100V, P-CHANNEL**  
**REF: MIL-PRF-19500/662**  
**RAD Hard™ HEXFET® TECHNOLOGY**

**Product Summary**

Part Number	Radiation Level	RDS(on)	I <sub>D</sub>	QPL Part Number
IRHN9150	100 kRads(Si)	0.080Ω	-22A	JANSR2N7422U
IRHN93150	300 kRads(Si)	0.080Ω	-22A	JANSF2N7422U



**Description**

IR HiRel RADHard™ HEXFET® MOSFET technology provides high performance power MOSFETs for space applications. This technology has long history of proven performance and reliability in satellite applications. These devices have been characterized for both Total Dose and Single Event Effects (SEE). The combination of low RDS(on) and low gate charge reduces the power losses in switching applications such as DC to DC converters and motor control. These devices retain all of the well established advantages of MOSFETs such as voltage control, fast switching and temperature stability of electrical parameters.

**Features**

- Single Event Effect (SEE) Hardened
- Low RDS(on)
- Low Total Gate Charge
- Proton Tolerant
- Simple Drive Requirements
- Hermetically Sealed
- Surface Mount
- Ceramic Package
- Light Weight
- ESD Rating: Class 2 per MIL-STD-750, Method 1020

**Absolute Maximum Ratings**

**Pre-Irradiation**

Symbol	Parameter	Value	Units
I <sub>D1</sub> @ V <sub>GS</sub> = -12V, T <sub>C</sub> = 25°C	Continuous Drain Current	-22	A
I <sub>D2</sub> @ V <sub>GS</sub> = -12V, T <sub>C</sub> = 100°C	Continuous Drain Current	-14	
I <sub>DM</sub> @ T <sub>C</sub> = 25°C	Pulsed Drain Current ①	-88	
P <sub>D</sub> @ T <sub>C</sub> = 25°C	Maximum Power Dissipation	150	W
	Linear Derating Factor	1.2	W/°C
V <sub>GS</sub>	Gate-to-Source Voltage	± 20	V
E <sub>AS</sub>	Single Pulse Avalanche Energy ②	500	mJ
I <sub>AR</sub>	Avalanche Current ①	-22	A
E <sub>AR</sub>	Repetitive Avalanche Energy ①	15	mJ
dv/dt	Peak Diode Recovery dv/dt ③	-23	V/ns
T <sub>J</sub> T <sub>STG</sub>	Operating Junction and Storage Temperature Range	-55 to + 150	°C
	Package Mounting Surface Temp.	300 ( for 5s)	
	Weight	2.6 (Typical)	g

For Footnotes, refer to the page 2.

**Electrical Characteristics @ T<sub>j</sub> = 25°C (Unless Otherwise Specified)**

Symbol	Parameter	Min.	Typ.	Max.	Units	Test Conditions
BV <sub>DSS</sub>	Drain-to-Source Breakdown Voltage	-100	—	—	V	V <sub>GS</sub> = 0V, I <sub>D</sub> = -1.0mA
ΔBV <sub>DSS</sub> /ΔT <sub>J</sub>	Breakdown Voltage Temp. Coefficient	—	-0.093	—	V/°C	Reference to 25°C, I <sub>D</sub> = -1.0mA
R <sub>DS(on)</sub>	Static Drain-to-Source On-Resistance	—	—	0.080	Ω	V <sub>GS</sub> = -12V, I <sub>D1</sub> = -14A ④
		—	—	0.085		V <sub>GS</sub> = -12V, I <sub>D1</sub> = -22A ④
V <sub>GS(th)</sub>	Gate Threshold Voltage	-2.0	—	-4.0	V	V <sub>DS</sub> = V <sub>GS</sub> , I <sub>D</sub> = -1.0mA
G <sub>fs</sub>	Forward Transconductance	11	—	—	S	V <sub>DS</sub> = -15V, I <sub>D2</sub> = -14A ④
I <sub>DSS</sub>	Zero Gate Voltage Drain Current	—	—	-25	μA	V <sub>DS</sub> = -80V, V <sub>GS</sub> = 0V
		—	—	-250		V <sub>DS</sub> = -80V, V <sub>GS</sub> = 0V, T <sub>J</sub> = 125°C
I <sub>GSS</sub>	Gate-to-Source Leakage Forward	—	—	-100	nA	V <sub>GS</sub> = -20V
	Gate-to-Source Leakage Reverse	—	—	100		V <sub>GS</sub> = 20V
Q <sub>G</sub>	Total Gate Charge	—	—	200	nC	I <sub>D1</sub> = -22A
Q <sub>GS</sub>	Gate-to-Source Charge	—	—	35		V <sub>DS</sub> = -50V
Q <sub>GD</sub>	Gate-to-Drain ('Miller') Charge	—	—	48		V <sub>GS</sub> = -12V
t <sub>d(on)</sub>	Turn-On Delay Time	—	—	40	ns	V <sub>DD</sub> = -50V
t <sub>r</sub>	Rise Time	—	—	170		I <sub>D1</sub> = -22A
t <sub>d(off)</sub>	Turn-Off Delay Time	—	—	190		R <sub>G</sub> = 2.35Ω
t <sub>f</sub>	Fall Time	—	—	190		V <sub>GS</sub> = -12V
L <sub>S</sub> + L <sub>D</sub>	Total Inductance	—	4.0	—	nH	Measured from the center of drain pad to center of source pad
C <sub>iss</sub>	Input Capacitance	—	4300	—	pF	V <sub>GS</sub> = 0V
C <sub>oss</sub>	Output Capacitance	—	1100	—		V <sub>DS</sub> = -25V
C <sub>rss</sub>	Reverse Transfer Capacitance	—	310	—		f = 1.0MHz

**Source-Drain Diode Ratings and Characteristics**

Symbol	Parameter	Min.	Typ.	Max.	Units	Test Conditions
I <sub>S</sub>	Continuous Source Current (Body Diode)	—	—	-22	A	
I <sub>SM</sub>	Pulsed Source Current (Body Diode) ①	—	—	-88		
V <sub>SD</sub>	Diode Forward Voltage	—	—	-3.0	V	T <sub>J</sub> = 25°C, I <sub>S</sub> = -22A, V <sub>GS</sub> = 0V ④
t <sub>rr</sub>	Reverse Recovery Time	—	—	300	ns	T <sub>J</sub> = 25°C, I <sub>F</sub> = -22A, V <sub>DD</sub> ≤ -50V
Q <sub>rr</sub>	Reverse Recovery Charge	—	—	1.5	μC	di/dt = -100A/μs ④
t <sub>on</sub>	Forward Turn-On Time	Intrinsic turn-on time is negligible (turn-on is dominated by L <sub>S</sub> +L <sub>D</sub> )				

**Thermal Resistance**

Symbol	Parameter	Min.	Typ.	Max.	Units
R <sub>θJC</sub>	Junction-to-Case	—	—	0.83	°C/W
R <sub>θJ-PCB</sub>	Junction-to-PC board (soldered to a 1"sq. copper-clad board)	—	6.6	—	

**Footnotes:**

- ① Repetitive Rating; Pulse width limited by maximum junction temperature.
- ② V<sub>DD</sub> = -25V, starting T<sub>J</sub> = 25°C, L = 2.1mH, Peak I<sub>L</sub> = -22A, V<sub>GS</sub> = -12V
- ③ I<sub>SD</sub> ≤ -22A, di/dt ≤ -450A/μs, V<sub>DD</sub> ≤ -100V, T<sub>J</sub> ≤ 150°C
- ④ Pulse width ≤ 300 μs; Duty Cycle ≤ 2%
- ⑤ Total Dose Irradiation with V<sub>GS</sub> Bias. -12 volt V<sub>GS</sub> applied and V<sub>DS</sub> = 0 during irradiation per MIL-STD-750, Method 1019, condition A.
- ⑥ Total Dose Irradiation with V<sub>DS</sub> Bias. -80 volt V<sub>DS</sub> applied and V<sub>GS</sub> = 0 during irradiation per MIL-STD-750, Method 1019, condition A.

## Radiation Characteristics

IR HiRel Radiation Hardened MOSFETs are tested to verify their radiation hardness capability. The hardness assurance program at IR HiRel is comprised of two radiation environments. Every manufacturing lot is tested for total ionizing dose (per notes 5 and 6) using the TO-3 package. Both pre- and post-irradiation performance are tested and specified using the same drive circuitry and test conditions in order to provide a direct comparison.

**Table1. Electrical Characteristics @ Tj = 25°C, Post Total Dose Irradiation ⑤⑥**

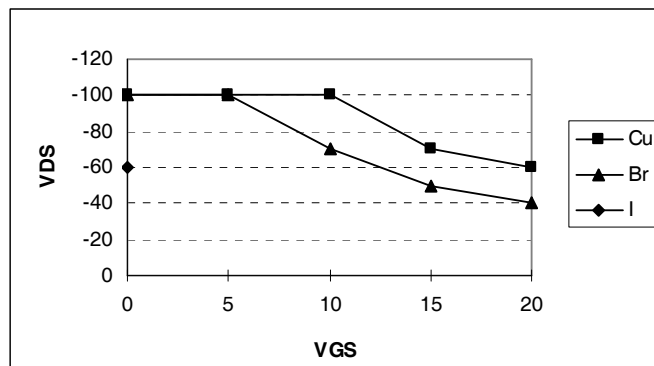
Symbol	Parameter	100 kRads (Si) <sup>1</sup>		300k Rads (Si) <sup>2</sup>		Units	Test Conditions
		Min.	Max.	Min.	Max.		
BV <sub>DSS</sub>	Drain-to-Source Breakdown Voltage	-100	—	-100	—	V	V <sub>GS</sub> = 0V, I <sub>D</sub> = -1.0mA
V <sub>GS(th)</sub>	Gate Threshold Voltage	-2.0	-4.0	-2.0	-5.0	V	V <sub>DS</sub> = V <sub>GS</sub> , I <sub>D</sub> = -1.0mA
I <sub>GSS</sub>	Gate-to-Source Leakage Forward	—	-100	—	-100	nA	V <sub>GS</sub> = -20V
I <sub>GSS</sub>	Gate-to-Source Leakage Reverse	—	100	—	100	nA	V <sub>GS</sub> = 20V
I <sub>DSS</sub>	Zero Gate Voltage Drain Current	—	-25	—	-25	μA	V <sub>DS</sub> = -80V, V <sub>GS</sub> = 0V
R <sub>DS(on)</sub>	Static Drain-to-Source ④ On-State Resistance (TO-3)	—	0.080	—	0.080	Ω	V <sub>GS</sub> = -12V, I <sub>D2</sub> = -14A
R <sub>DS(on)</sub>	Static Drain-to-Source ④ On-State Resistance (SMD-1)	—	0.080	—	0.080	Ω	V <sub>GS</sub> = -12V, I <sub>D2</sub> = -14A
V <sub>SD</sub>	Diode Forward Voltage ④	—	-3.0	—	-3.0	V	V <sub>GS</sub> = 0V, I <sub>S</sub> = -22A

1. Part numbers IRHN9150 (JANSR2N7422U)
2. Part numbers IRHN93150 (JANSF2N7422U)

IR HiRel radiation hardened MOSFETs have been characterized in heavy ion environment for Single Event Effects (SEE). Single Event Effects characterization is illustrated in Fig. a and Table 2.

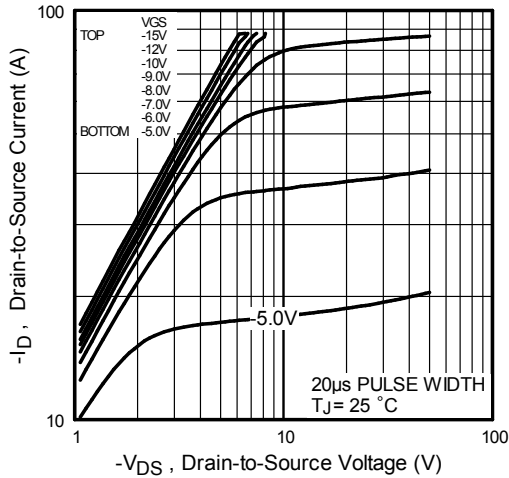
**Table 2. Typical Single Event Effect Safe Operating Area**

Ion	LET (MeV/(mg/cm <sup>2</sup> ))	Energy (MeV)	Range (μm)	VDS (V)				
				@ VGS = 0V	@ VGS = 5V	@ VGS = 10V	@ VGS = 15V	@ VGS = 20V
Cu	28	285	43	-100	-100	-100	-70	-60
Br	36.8	305	39	-100	-100	-70	-50	-40
I	59.9	345	32.8	-60	—	—	—	—

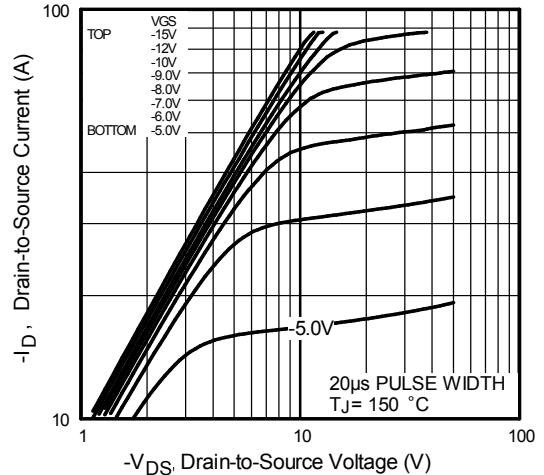


**Fig a.** Typical Single Event Effect, Safe Operating Area

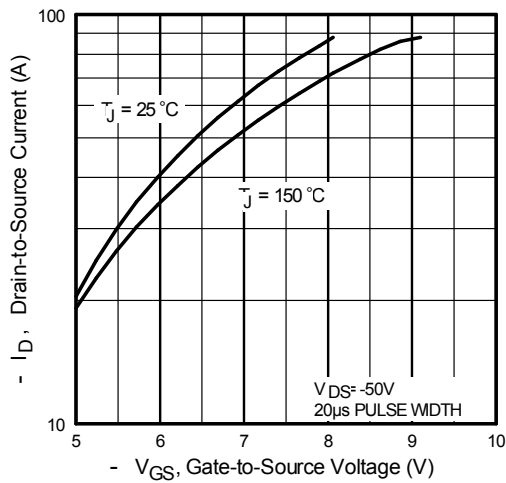
For Footnotes, refer to the page 2.



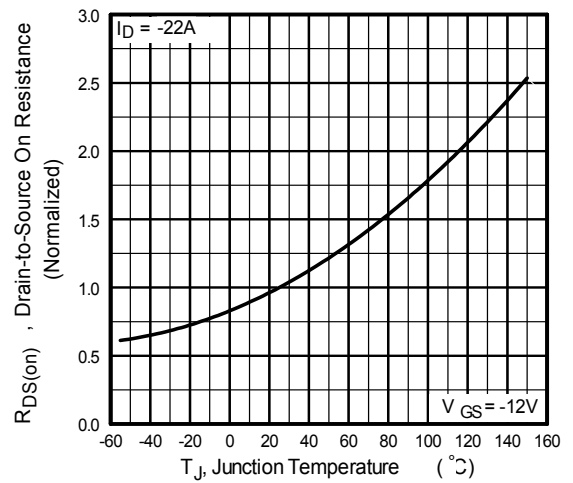
**Fig 1. Typical Output Characteristics**



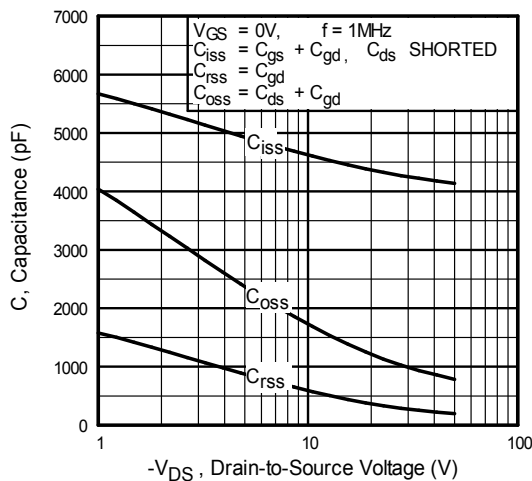
**Fig 2. Typical Output Characteristics**



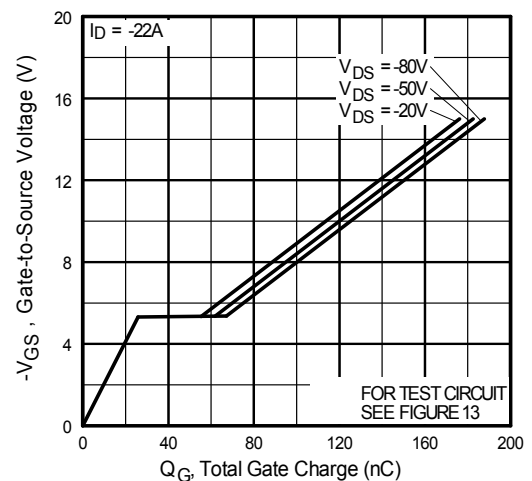
**Fig 3. Typical Transfer Characteristics**



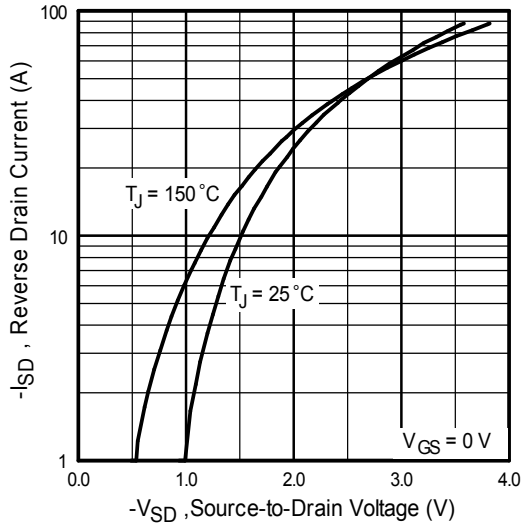
**Fig 4. Normalized On-Resistance Vs. Temperature**



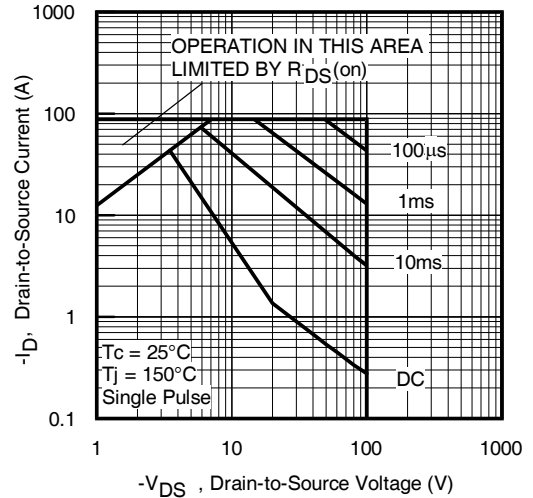
**Fig 5. Typical Capacitance Vs. Drain-to-Source Voltage**



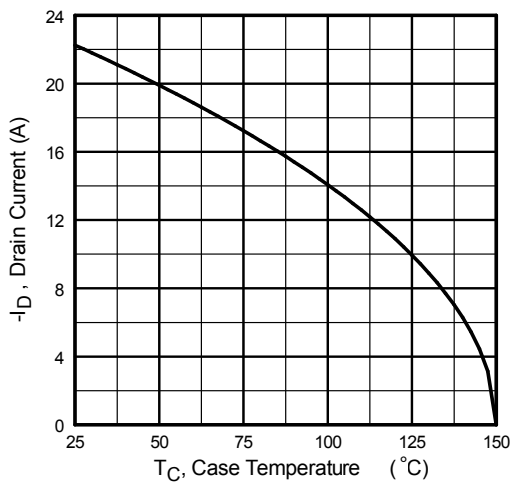
**Fig 6. Typical Gate Charge Vs. Gate-to-Source Voltage**



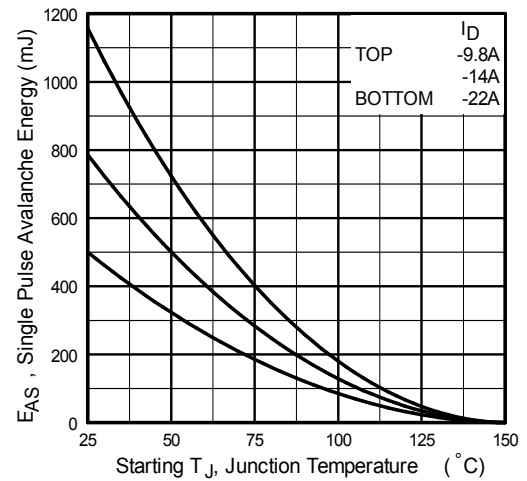
**Fig 7.** Typical Source-Drain Diode Forward Voltage



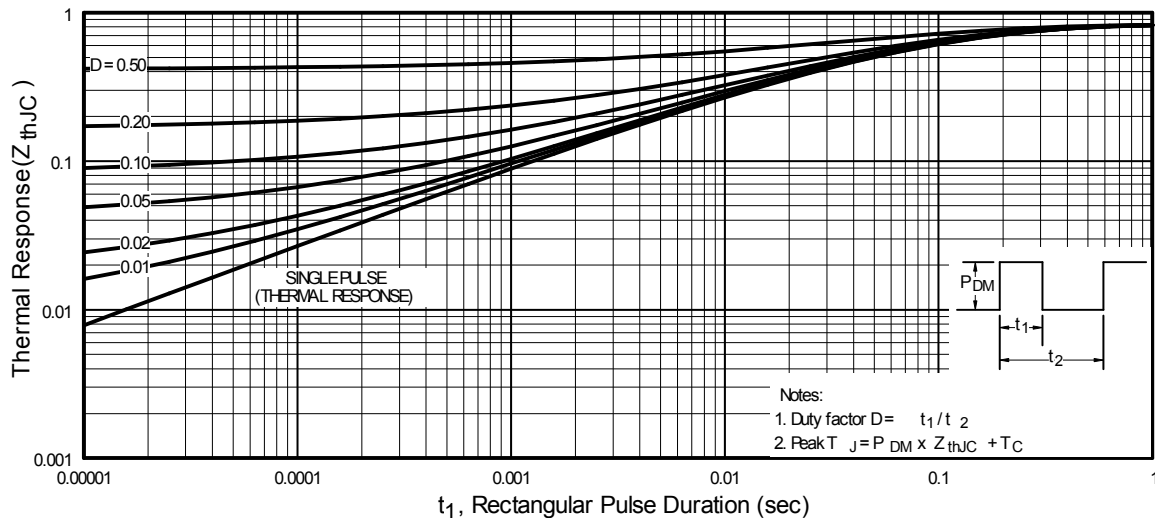
**Fig 8.** Maximum Safe Operating Area



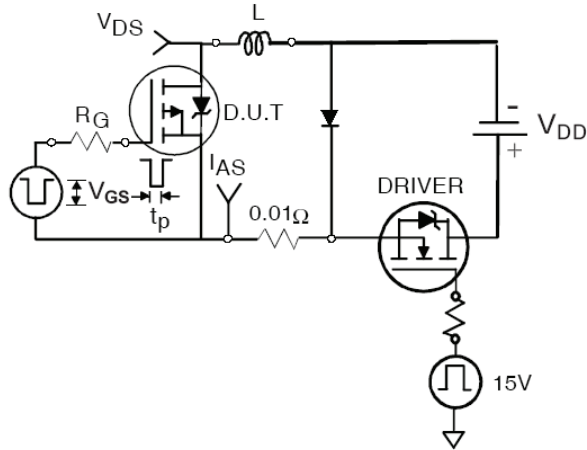
**Fig 9.** Maximum Drain Current Vs. Case Temperature



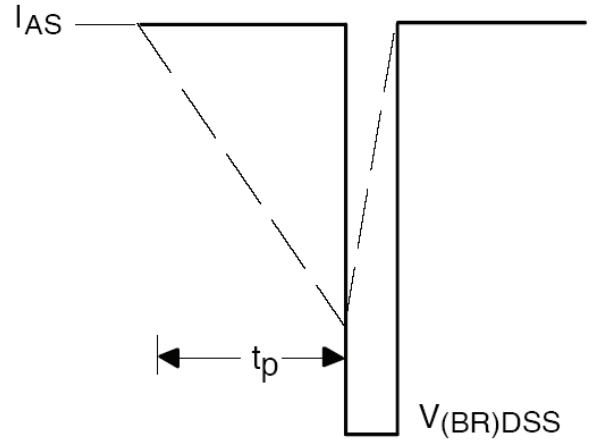
**Fig 10.** Maximum Avalanche Energy Vs. Drain Current



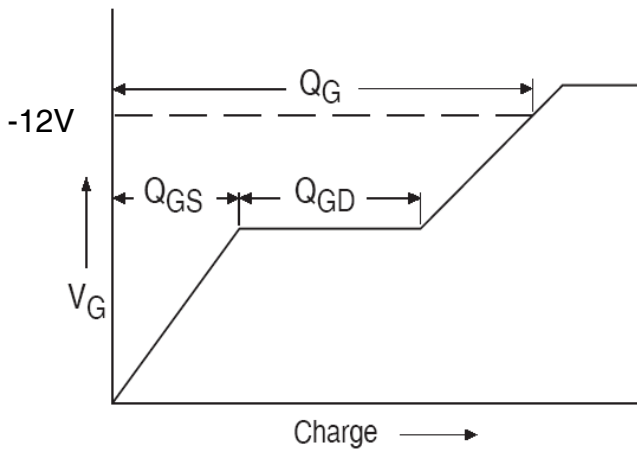
**Fig 11.** Maximum Effective Transient Thermal Impedance, Junction-to-Case



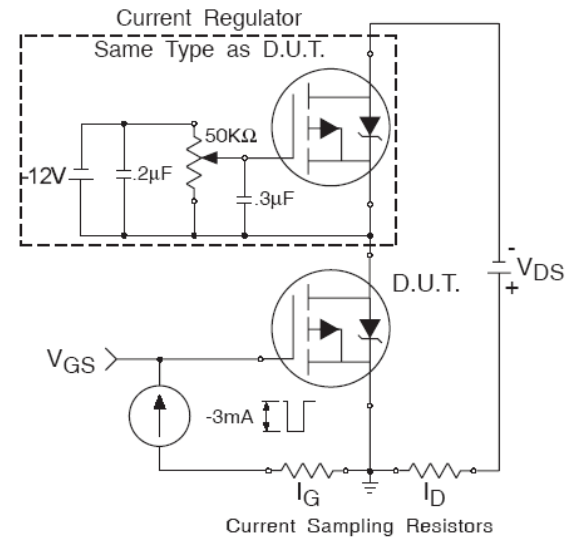
**Fig 12a.** Unclamped Inductive Test Circuit



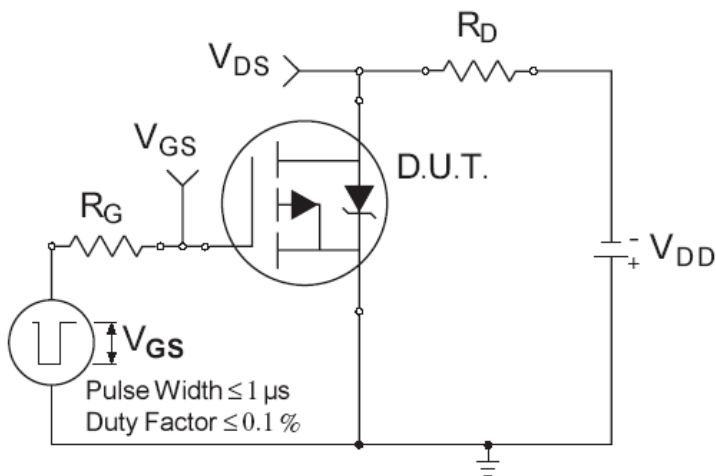
**Fig 12b.** Unclamped Inductive Waveforms



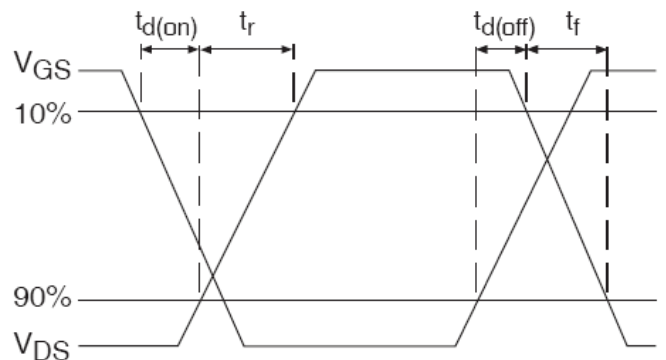
**Fig 13a.** Basic Gate Charge Waveform



**Fig 13b.** Gate Charge Test Circuit

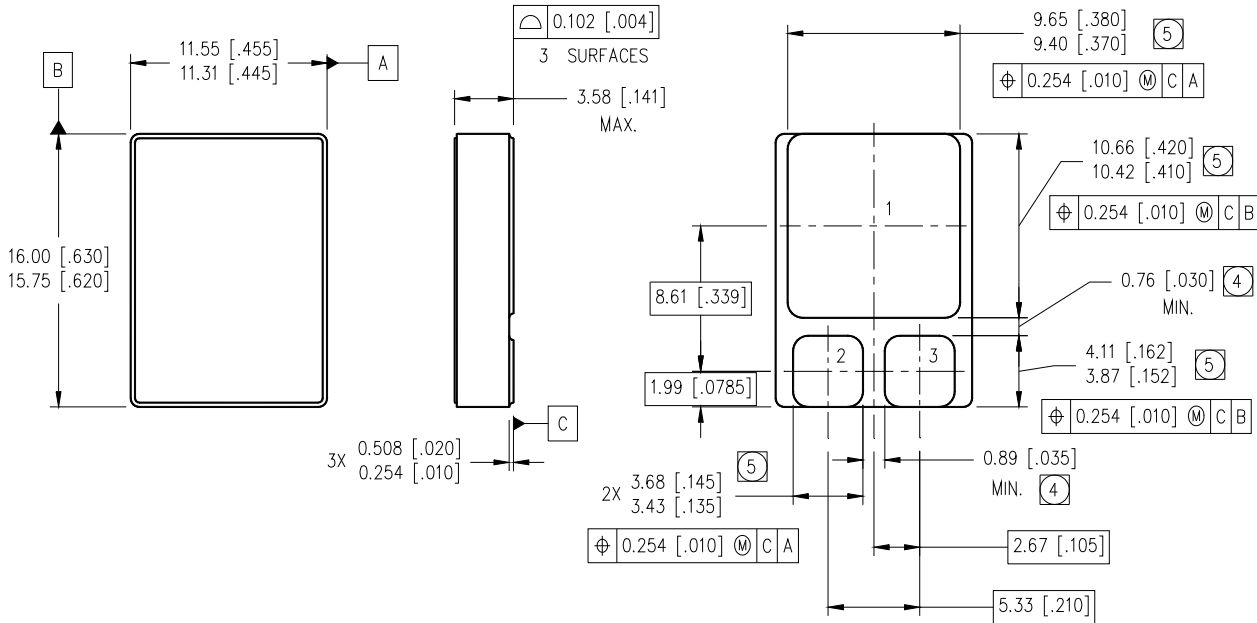


**Fig 14a.** Switching Time Test Circuit



**Fig 14b.** Switching Time Waveforms

**Case Outline and Dimensions - SMD-1**



**NOTES:**

1. DIMENSIONING & TOLERANCING PER ASME Y14.5M-1994.
2. CONTROLLING DIMENSION: INCH.
3. DIMENSIONS ARE SHOWN IN MILLIMETERS [INCHES].
4. DIMENSION INCLUDES METALLIZATION FLASH.
5. DIMENSION DOES NOT INCLUDE METALLIZATION FLASH.

PAD ASSIGNMENTS

MOSFET	SCHOTTKY SINGLE DIE	SCHOTTKY DUAL DIE
1 = DRAIN	1 = CATHODE	1 = CATHODE
2 = GATE	2 = COMMON ANODE	2 = ANODE 1
3 = SOURCE	3 = COMMON ANODE	3 = ANODE 2

### **IMPORTANT NOTICE**

The information given in this document shall be in no event regarded as guarantee of conditions or characteristic. The data contained herein is a characterization of the component based on internal standards and is intended to demonstrate and provide guidance for typical part performance. It will require further evaluation, qualification and analysis to determine suitability in the application environment to confirm compliance to your system requirements.

With respect to any example hints or any typical values stated herein and/or any information regarding the application of the product, Infineon Technologies hereby disclaims any and all warranties and liabilities of any kind including without limitation warranties on non- infringement of intellectual property rights and any third party.

In addition, any information given in this document is subject to customer's compliance with its obligations stated in this document and any applicable legal requirements, norms and standards concerning customer's product and any use of the product of Infineon Technologies in customer's applications.

The data contained in this document is exclusively intended for technically trained staff. It is the responsibility of any customer's technical departments to evaluate the suitability of the product for the intended applications and the completeness of the product information given in this document with respect to applications.

For further information on the product, technology, delivery terms and conditions and prices, please contact your local sales representative or go to [www.infineon.com/hirel](http://www.infineon.com/hirel).

### **WARNING**

Due to technical requirements products may contain dangerous substances. For information on the types in question, please contact your nearest Infineon Technologies office.



单击下面可查看定价，库存，交付和生命周期等信息

[>>Infineon Technologies\(英飞凌\)](#)