

## CoolMOS™ Power Transistor

### Features

- New revolutionary high voltage technology
- Extreme dv/dt rated
- High peak current capability
- Qualified according to JEDEC<sup>1)</sup> for target applications
- Pb-free lead plating; RoHS compliant
- Ultra low gate charge
- Ultra low effective capacitances
- Fully isolated package (2500 VAC; 1 minute)

### CoolMOS™ 800V designed for:

- Industrial application with high DC bulk voltage
- Switching Application ( i.e. active clamp forward )

### Product Summary

$V_{DS}$	800	V
$R_{DS(on)max}$ @ $T_j = 25^\circ\text{C}$	0.9	$\Omega$
$Q_{g,typ}$	31	nC

PG-TO220-3 (fully isolated)



Type	Package	Marking
SPA06N80C3	PG-TO220-3	06N80C3

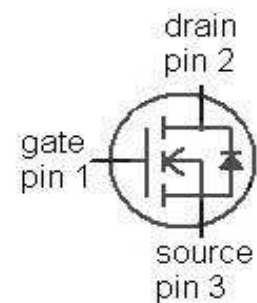

**Maximum ratings**, at  $T_j=25^\circ\text{C}$ , unless otherwise specified

Parameter	Symbol	Conditions	Value	Unit
Continuous drain current <sup>2)</sup>	$I_D$	$T_C=25^\circ\text{C}$	6	A
		$T_C=100^\circ\text{C}$	3.8	
Pulsed drain current <sup>3)</sup>	$I_{D,pulse}$	$T_C=25^\circ\text{C}$	18	
Avalanche energy, single pulse	$E_{AS}$	$I_D=1.2\text{ A}, V_{DD}=50\text{ V}$	230	mJ
Avalanche energy, repetitive $t_{AR}$ <sup>3),4)</sup>	$E_{AR}$	$I_D=6\text{ A}, V_{DD}=50\text{ V}$	0.2	
Avalanche current, repetitive $t_{AR}$ <sup>3),4)</sup>	$I_{AR}$		6	A
MOSFET dv/dt ruggedness	dv/dt	$V_{DS}=0\dots640\text{ V}$	50	V/ns
Gate source voltage	$V_{GS}$	static	$\pm 20$	V
		AC ( $f>1\text{ Hz}$ )	$\pm 30$	
Power dissipation	$P_{tot}$	$T_C=25^\circ\text{C}$	39	W
Operating and storage temperature	$T_j, T_{stg}$		-55 ... 150	$^\circ\text{C}$
Mounting torque		M2.5 screws	50	Ncm

**Maximum ratings**, at  $T_j=25\text{ °C}$ , unless otherwise specified

Parameter	Symbol	Conditions	Value	Unit
Continuous diode forward current	$I_S$	$T_C=25\text{ °C}$	6	A
Diode pulse current <sup>3)</sup>	$I_{S,pulse}$		18	
Reverse diode $dv/dt$ <sup>5)</sup>	$dv/dt$		4	V/ns

Parameter	Symbol	Conditions	Values			Unit
			min.	typ.	max.	

**Thermal characteristics**

Thermal resistance, junction - case	$R_{thJC}$		-	-	3.9	K/W
Thermal resistance, junction - ambient	$R_{thJA}$	leaded	-	-	80	
Soldering temperature, wave soldering only allowed at leads	$T_{sold}$	1.6 mm (0.063 in.) from case for 10s	-	-	260	°C

**Electrical characteristics**, at  $T_j=25\text{ °C}$ , unless otherwise specified

**Static characteristics**

Drain-source breakdown voltage	$V_{(BR)DSS}$	$V_{GS}=0\text{ V}$ , $I_D=250\text{ }\mu\text{A}$	800	-	-	V
Avalanche breakdown voltage	$V_{(BR)DS}$	$V_{GS}=0\text{ V}$ , $I_D=6\text{ A}$	-	870	-	
Gate threshold voltage	$V_{GS(th)}$	$V_{DS}=V_{GS}$ , $I_D=0.25\text{ mA}$	2.1	3	3.9	
Zero gate voltage drain current	$I_{DSS}$	$V_{DS}=800\text{ V}$ , $V_{GS}=0\text{ V}$ , $T_j=25\text{ °C}$	-	-	10	$\mu\text{A}$
		$V_{DS}=800\text{ V}$ , $V_{GS}=0\text{ V}$ , $T_j=150\text{ °C}$	-	50	-	
Gate-source leakage current	$I_{GSS}$	$V_{GS}=20\text{ V}$ , $V_{DS}=0\text{ V}$	-	-	100	nA
Drain-source on-state resistance	$R_{DS(on)}$	$V_{GS}=10\text{ V}$ , $I_D=3.8\text{ A}$ , $T_j=25\text{ °C}$	-	0.78	0.9	$\Omega$
		$V_{GS}=10\text{ V}$ , $I_D=3.8\text{ A}$ , $T_j=150\text{ °C}$	-	2.1	-	
Gate resistance	$R_G$	$f=1\text{ MHz}$ , open drain	-	1.2	-	$\Omega$

Parameter	Symbol	Conditions	Values			Unit
			min.	typ.	max.	

**Dynamic characteristics**

Input capacitance	$C_{iss}$	$V_{GS}=0\text{ V}, V_{DS}=100\text{ V},$	-	785	-	pF
Output capacitance	$C_{oss}$	$f=1\text{ MHz}$	-	33	-	
Effective output capacitance, energy related <sup>6)</sup>	$C_{o(er)}$	$V_{GS}=0\text{ V}, V_{DS}=0\text{ V}$ to 480 V	-	26	-	
Effective output capacitance, time related <sup>7)</sup>	$C_{o(tr)}$		-	69	-	
Turn-on delay time	$t_{d(on)}$	$V_{DD}=400\text{ V},$ $V_{GS}=0/10\text{ V}, I_D=6\text{ A},$ $R_G=15\text{ }\Omega, T_j=25\text{ }^\circ\text{C}$	-	25	-	ns
Rise time	$t_r$		-	15	-	
Turn-off delay time	$t_{d(off)}$		-	72	-	
Fall time	$t_f$		-	8	-	

**Gate Charge Characteristics**

Gate to source charge	$Q_{gs}$	$V_{DD}=640\text{ V}, I_D=6\text{ A},$ $V_{GS}=0\text{ to }10\text{ V}$	-	4	-	nC
Gate to drain charge	$Q_{gd}$		-	15	-	
Gate charge total	$Q_g$		-	31	41	
Gate plateau voltage	$V_{plateau}$		-	5.5	-	V

**Reverse Diode**

Diode forward voltage	$V_{SD}$	$V_{GS}=0\text{ V}, I_F=I_S=6\text{ A},$ $T_j=25\text{ }^\circ\text{C}$	-	1	1.2	V
Reverse recovery time	$t_{rr}$	$V_R=400\text{ V}, I_F=I_S=6\text{ A},$ $di_F/dt=100\text{ A}/\mu\text{s}$	-	520	-	ns
Reverse recovery charge	$Q_{rr}$		-	5	-	$\mu\text{C}$
Peak reverse recovery current	$I_{rrm}$		-	18	-	A

<sup>1)</sup> J-STD20 and JESD22

<sup>2)</sup> Limited only by maximum temperature

<sup>3)</sup> Pulse width  $t_p$  limited by  $T_{j,max}$ 
<sup>4)</sup> Repetitive avalanche causes additional power losses that can be calculated as  $P_{AV}=E_{AR} \cdot f$ .

<sup>5)</sup>  $I_{SD}=I_D, di/dt=400\text{ A}/\mu\text{s}, V_{DClink}=400\text{ V}, V_{peak}<V_{(BR)DSS}, T_j<T_{j,max}$ , identical low side and high side switch

<sup>6)</sup>  $C_{o(er)}$  is a fixed capacitance that gives the same stored energy as  $C_{oss}$  while  $V_{DS}$  is rising from 0 to 80%  $V_{DSS}$ .

<sup>7)</sup>  $C_{o(tr)}$  is a fixed capacitance that gives the same charging time as  $C_{oss}$  while  $V_{DS}$  is rising from 0 to 80%  $V_{DSS}$ .

### 1 Power dissipation

$$P_{tot}=f(T_C)$$

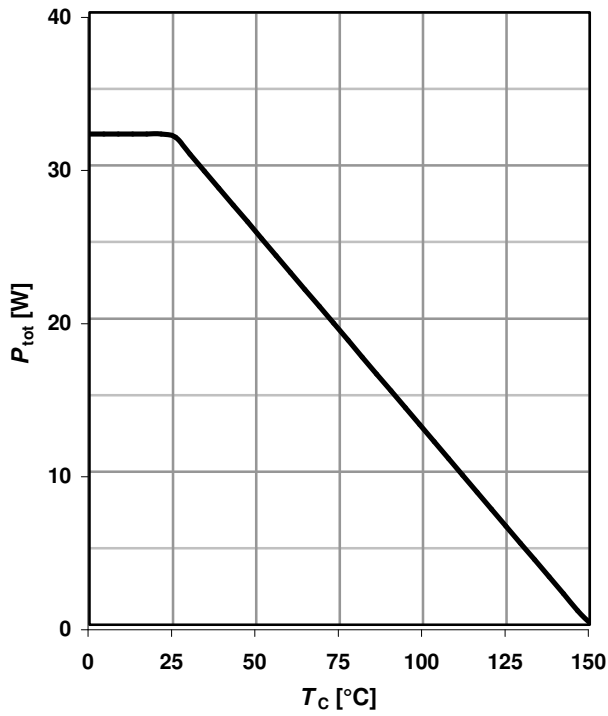

### 2 Safe operating area

$$I_D=f(V_{DS}); T_C=25\text{ }^\circ\text{C}; D=0$$

parameter:  $t_p$

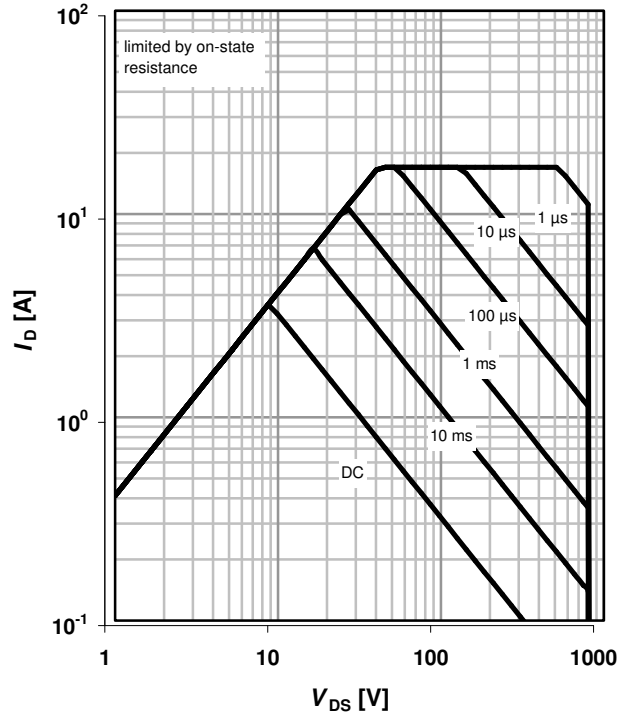

### 3 Max. transient thermal impedance

$$Z_{thJC}=f(t_p)$$

parameter:  $D=t_p/T$

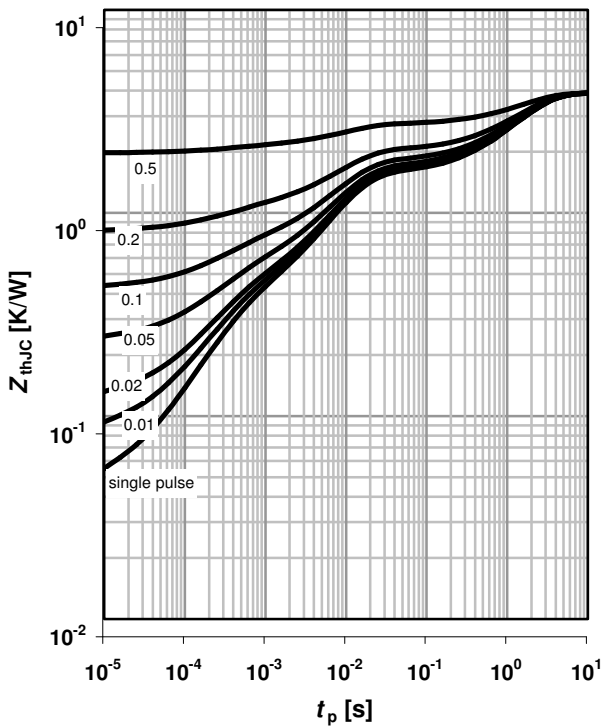

### 4 Typ. output characteristics

$$I_D=f(V_{DS}); T_j=25\text{ }^\circ\text{C}; t_p=10\text{ }\mu\text{s}$$

parameter:  $V_{GS}$

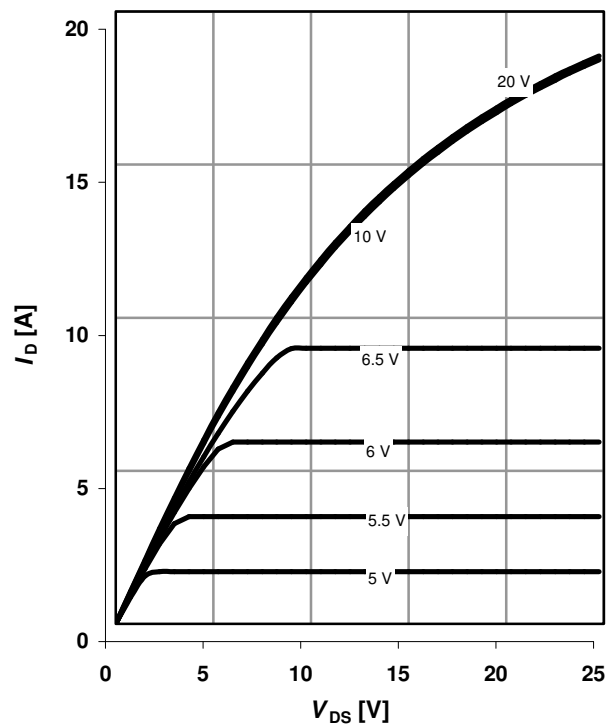

**5 Typ. output characteristics**

$I_D=f(V_{DS}); T_j=150\text{ °C}; t_p=10\text{ }\mu\text{s}$

parameter:  $V_{GS}$

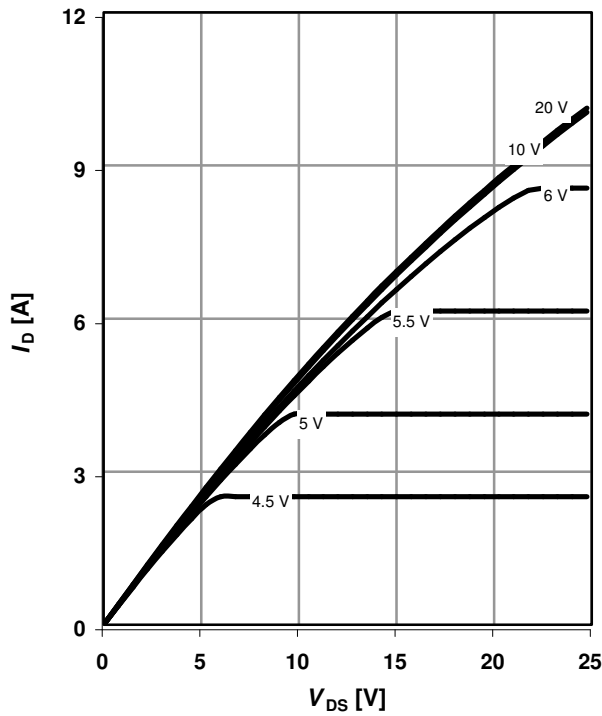

**6 Typ. drain-source on-state resistance**

$R_{DS(on)}=f(I_D); T_j=150\text{ °C}$

parameter:  $V_{GS}$

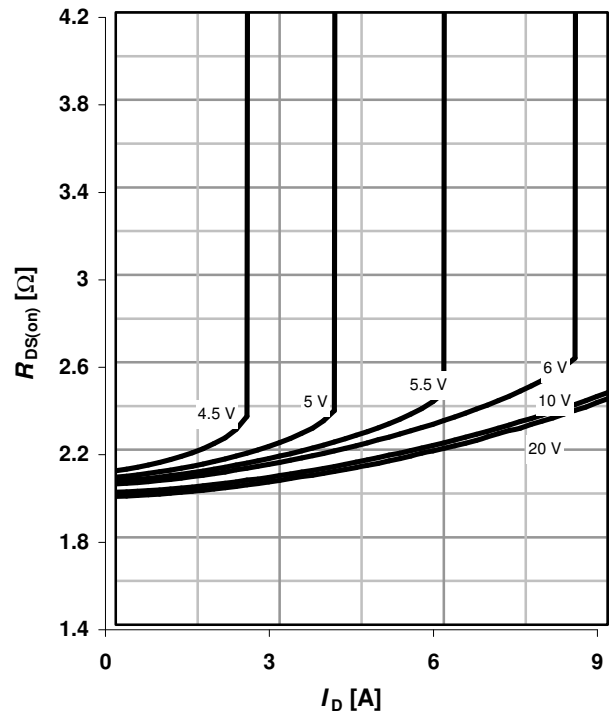

**7 Drain-source on-state resistance**

$R_{DS(on)}=f(T_j); I_D=3.8\text{ A}; V_{GS}=10\text{ V}$

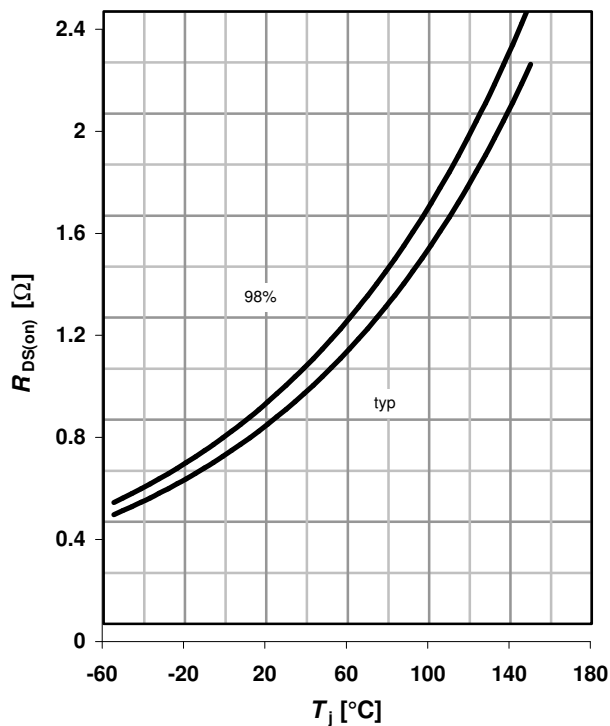

**8 Typ. transfer characteristics**

$I_D=f(V_{GS}); |V_{DS}|>2|I_D|R_{DS(on)max}; t_p=10\text{ }\mu\text{s}$

parameter:  $T_j$

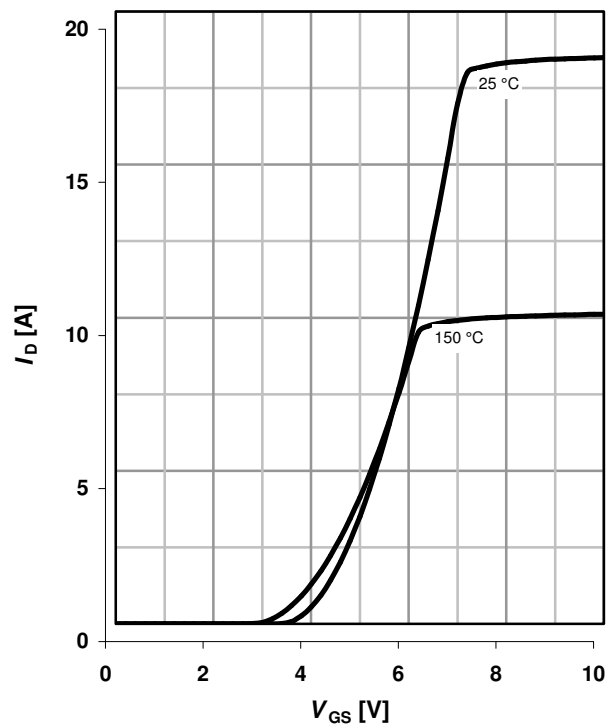

**9 Typ. gate charge**

$V_{GS}=f(Q_{gate}); I_D=6\text{ A pulsed}$   
 parameter:  $V_{DD}$

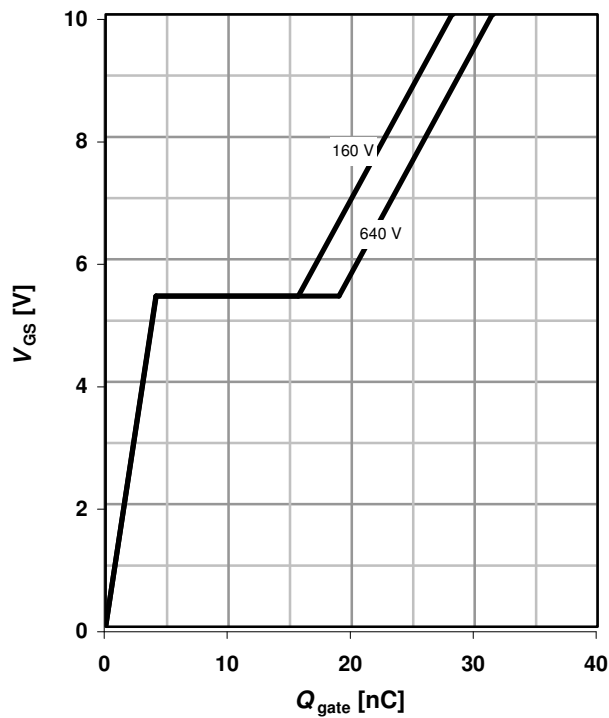

**10 Forward characteristics of reverse diode**

$I_F=f(V_{SD}); t_p=10\ \mu\text{s}$   
 parameter:  $T_j$

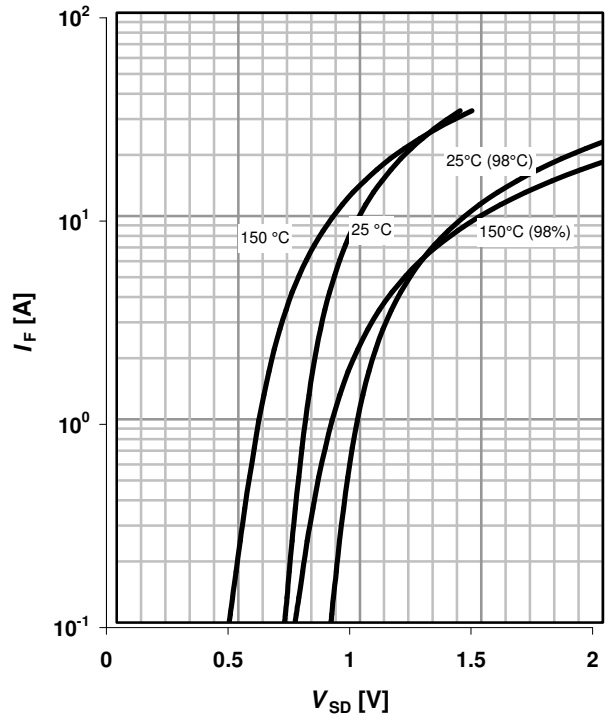

**11 Avalanche energy**

$E_{AS}=f(T_j); I_D=1.2\text{ A}; V_{DD}=50\text{ V}$

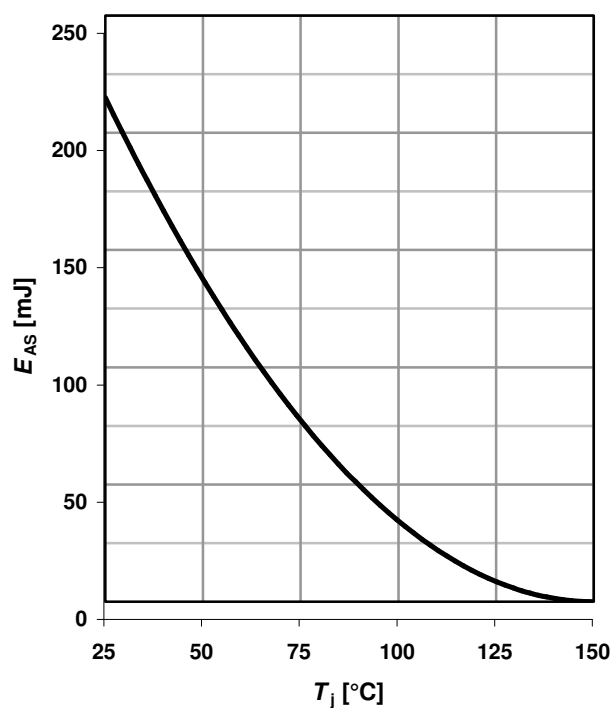

**12 Drain-source breakdown voltage**

$V_{BR(DSS)}=f(T_j); I_D=0.25\text{ mA}$

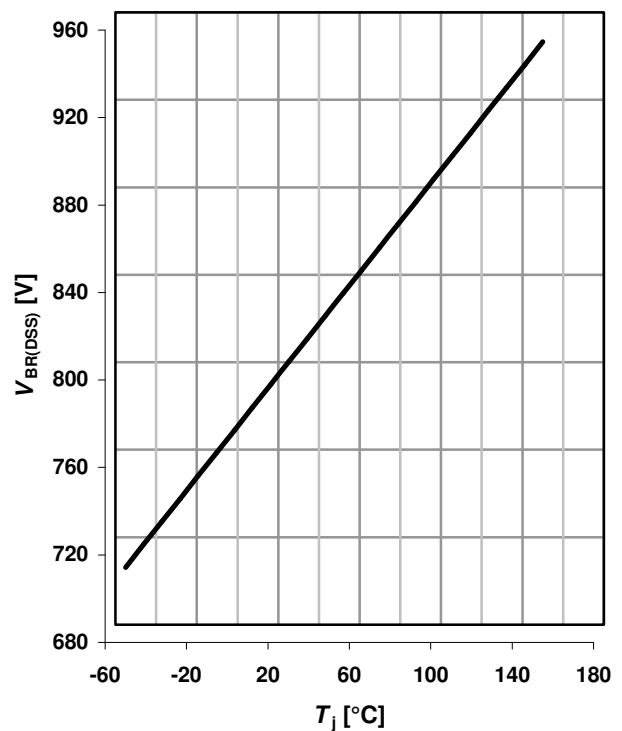

**13 Typ. capacitances**

$C=f(V_{DS}); V_{GS}=0\text{ V}; f=1\text{ MHz}$

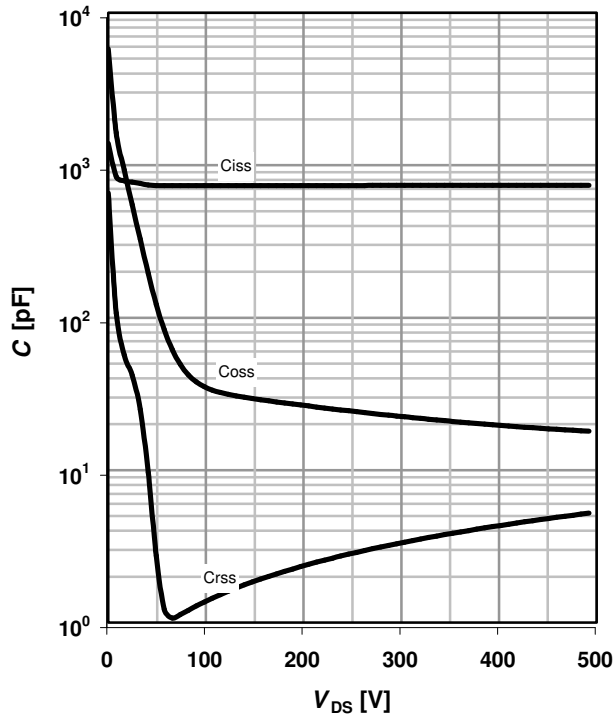

**14 Typ. Coss stored energy**

$E_{oss}=f(V_{DS})$

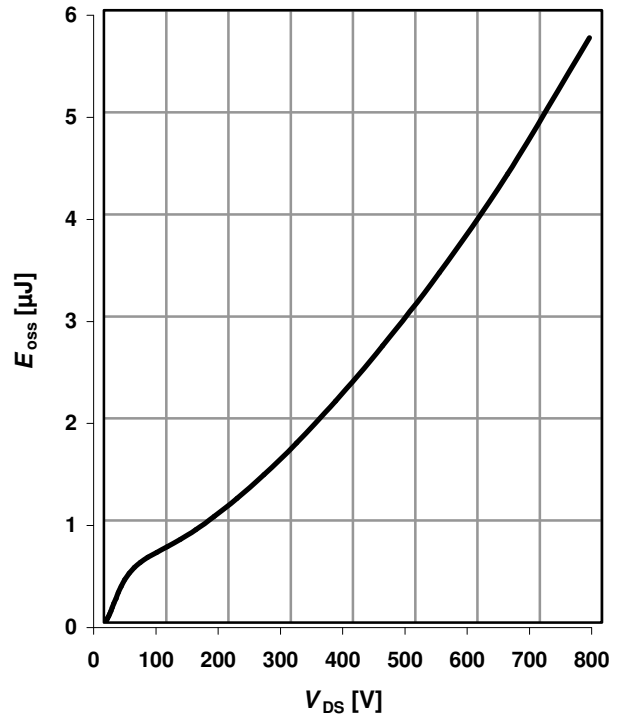

Definition of diode switching characteristics





Outline PG-TO220 FullPAK

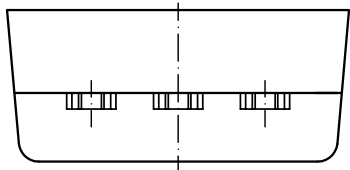
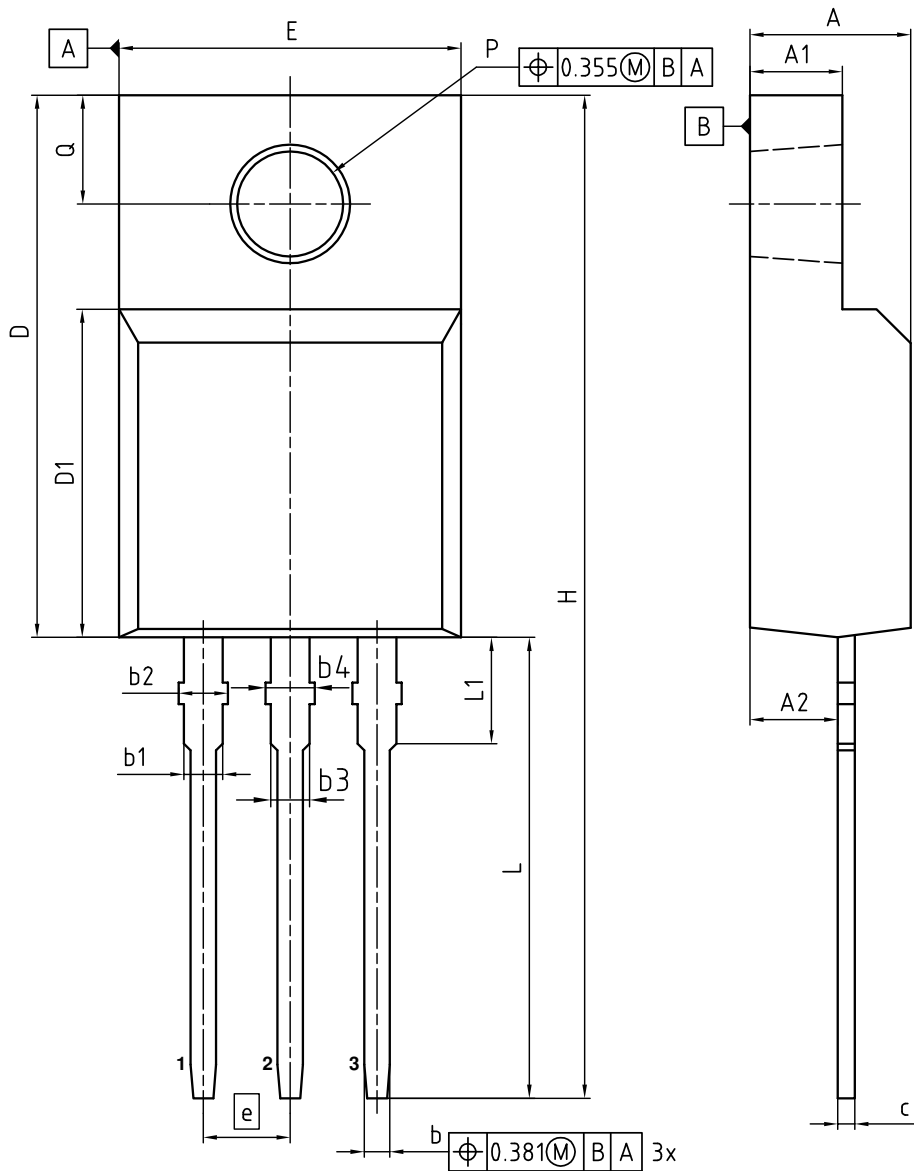

NOTES:  
 ALL DIMENSIONS REFER TO JEDEC STANDARD TO-281  
 AND DOES NOT INCLUDE MOLD FLASH, PROTRUSIONS  
 OR GATE BURRS  
 GATE BURRS ARE LESS THAN 0.5 mm

DIMENSIONS	MILLIMETERS	
	MIN.	MAX.
A	4.50	4.90
A1	2.34	2.85
A2	2.42	2.86
b	0.65	0.90
b1	0.95	1.38
b2	0.95	1.51
b3	0.65	1.38
b4	0.65	1.51
c	0.40	0.63
D	15.67	16.15
D1	8.97	9.83
E	10.00	10.65
e	2.54	
H	28.70	29.75
L	12.78	13.75
L1	2.83	3.45
øP	3.00	3.30
Q	3.15	3.50

<b>DOCUMENT NO.</b> Z8B00003319
<b>REVISION</b> 07
<b>SCALE 5:1</b> 0 1 2 3 4 5mm
<b>EUROPEAN PROJECTION</b> 
<b>ISSUE DATE</b> 27.01.2017

# 800V CoolMOS™ C3 Power Transistor

## SPA06N80C3

### Revision History

SPA06N80C3

**Revision: 2018-02-27, Rev. 2.92**

Previous Revision

Revision	Date	Subjects (major changes since last revision)
2.92	2018-02-27	Outline PG-TO-220 FullPAK update

#### Trademarks of Infineon Technologies AG

AURIX™, C166™, CanPAK™, CIPOS™, CoolGaN™, CoolMOS™, CoolSET™, CoolSiC™, CORECONTROL™, CROSSAVE™, DAVE™, DI-POL™, DrBlade™, EasyPIM™, EconoBRIDGE™, EconoDUAL™, EconoPACK™, EconoPIM™, EiceDRIVER™, eupec™, FCOS™, HITFET™, HybridPACK™, Infineon™, ISOFACE™, IsoPACK™, i-Wafer™, MIPAQ™, ModSTACK™, my-d™, NovalithIC™, OmniTune™, OPTIGA™, OptiMOS™, ORIGA™, POWERCODE™, PRIMARION™, PrimePACK™, PrimeSTACK™, PROFET™, PRO-SIL™, RASIC™, REAL3™, ReverSave™, SatRIC™, SIEGET™, SIPMOS™, SmartLEWIS™, SOLID FLASH™, SPOC™, TEMPFET™, thinQ!™, TRENCHSTOP™, TriCore™.

Trademarks updated August 2015

#### Other Trademarks

All referenced product or service names and trademarks are the property of their respective owners.

#### We Listen to Your Comments

Any information within this document that you feel is wrong, unclear or missing at all? Your feedback will help us to continuously improve the quality of this document. Please send your proposal (including a reference to this document) to:

[erratum@infineon.com](mailto:erratum@infineon.com)

#### Published by

**Infineon Technologies AG**

**81726 München, Germany**

**© 2018 Infineon Technologies AG**

**All Rights Reserved.**

#### Legal Disclaimer

The information given in this document shall in no event be regarded as a guarantee of conditions or characteristics ("Beschaffheitsgarantie").

With respect to any examples, hints or any typical values stated herein and/or any information regarding the application of the product, Infineon Technologies hereby disclaims any and all warranties and liabilities of any kind, including without limitation warranties of non-infringement of intellectual property rights of any third party.

In addition, any information given in this document is subject to customer's compliance with its obligations stated in this document and any applicable legal requirements, norms and standards concerning customer's products and any use of the product of Infineon Technologies in customer's applications.

The data contained in this document is exclusively intended for technically trained staff. It is the responsibility of customer's technical departments to evaluate the suitability of the product for the intended application and the completeness of the product information given in this document with respect to such application.

#### Information

For further information on technology, delivery terms and conditions and prices please contact your nearest Infineon Technologies Office ([www.infineon.com](http://www.infineon.com)).

#### Warnings

Due to technical requirements, components may contain dangerous substances. For information on the types in question, please contact the nearest Infineon Technologies Office.

The Infineon Technologies component described in this Data Sheet may be used in life-support devices or systems and/or automotive, aviation and aerospace applications or systems only with the express written approval of Infineon Technologies, if a failure of such components can reasonably be expected to cause the failure of that life-support, automotive, aviation and aerospace device or system or to affect the safety or effectiveness of that device or system. Life support devices or systems are intended to be implanted in the human body or to support and/or maintain and sustain and/or protect human life. If they fail, it is reasonable to assume that the health of the user or other persons may be endangered.

单击下面可查看定价，库存，交付和生命周期等信息

[>>Infineon Technologies\(英飞凌\)](#)

[>>点击查看相关商品](#)