

# IRG4BC20UDPbF

INSULATED GATE BIPOLAR TRANSISTOR WITH ULTRAFAST  
 SOFT RECOVERY DIODE

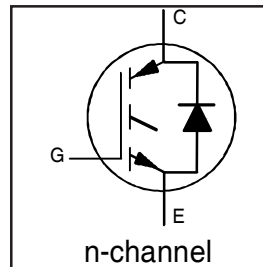
UltraFast CoPack IGBT

## Features

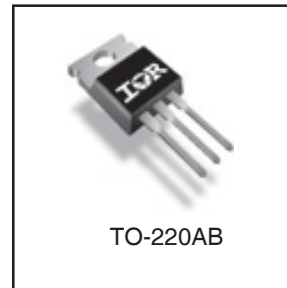
- UltraFast: optimized for high operating frequencies 8-40 kHz in hard switching, >200 kHz in resonant mode
- Generation 4 IGBT design provides tighter parameter distribution and higher efficiency than Generation 3
- IGBT co-packaged with HEXFRED® ultrafast, ultra-soft-recovery anti-parallel diodes for use in bridge configurations
- Industry standard TO-220AB package
- Lead-Free

## Benefits

- Generation -4 IGBTs offer highest efficiencies available
- IGBTs optimized for specific application conditions
- HEXFRED diodes optimized for performance with IGBTs. Minimized recovery characteristics require less/no snubbing
- Designed to be a "drop-in" replacement for equivalent industry-standard Generation 3 IR IGBTs



$V_{CES} = 600V$
$V_{CE(on) typ.} = 1.85V$
@ $V_{GE} = 15V, I_C = 6.5A$



## Absolute Maximum Ratings

	Parameter	Max.	Units
$V_{CES}$	Collector-to-Emitter Voltage	600	V
$I_C @ T_C = 25^\circ C$	Continuous Collector Current	13	A
$I_C @ T_C = 100^\circ C$	Continuous Collector Current	6.5	
$I_{CM}$	Pulsed Collector Current ①	52	
$I_{LM}$	Clamped Inductive Load Current ②	52	
$I_F @ T_C = 100^\circ C$	Diode Continuous Forward Current	7.0	
$I_{FM}$	Diode Maximum Forward Current	52	
$V_{GE}$	Gate-to-Emitter Voltage	$\pm 20$	V
$P_D @ T_C = 25^\circ C$	Maximum Power Dissipation	60	W
$P_D @ T_C = 100^\circ C$	Maximum Power Dissipation	24	
$T_J$	Operating Junction and Storage Temperature Range	-55 to +150	°C
$T_{STG}$			
	Mounting Torque, 6-32 or M3 Screw.	10 lbf•in (1.1 N•m)	

## Thermal Resistance

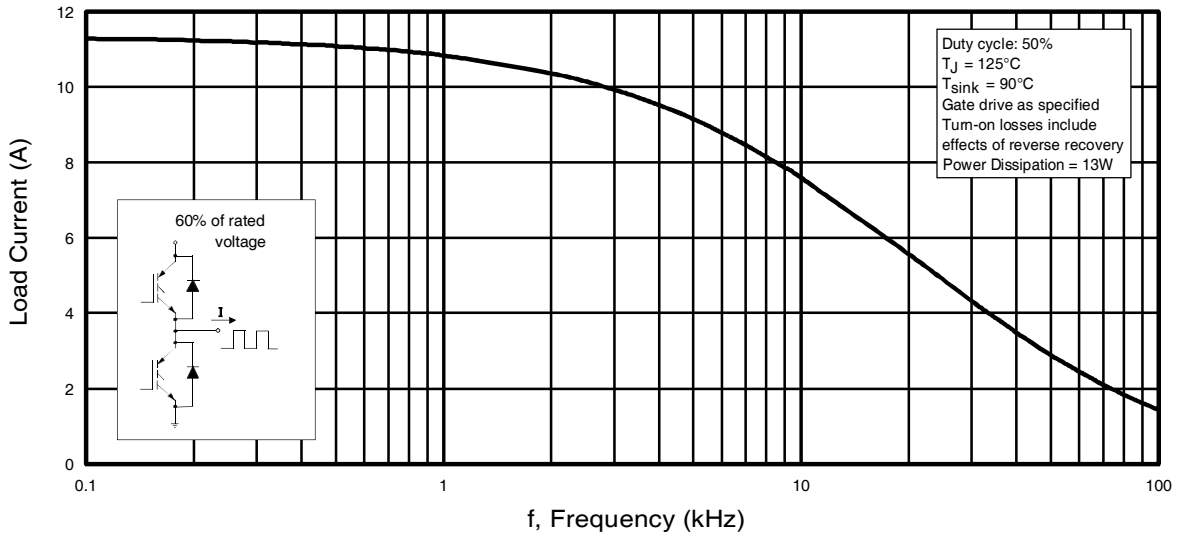
	Parameter	Min.	Typ.	Max.	Units
$R_{\theta JC}$	Junction-to-Case - IGBT	-----	-----	2.1	°C/W
$R_{\theta JC}$	Junction-to-Case - Diode	-----	-----	3.5	
$R_{\theta CS}$	Case-to-Sink, flat, greased surface	-----	0.50	-----	
$R_{\theta JA}$	Junction-to-Ambient, typical socket mount	-----	-----	80	
Wt	Weight	-----	2 (0.07)	-----	g (oz)

## Electrical Characteristics @ $T_J = 25^\circ\text{C}$ (unless otherwise specified)

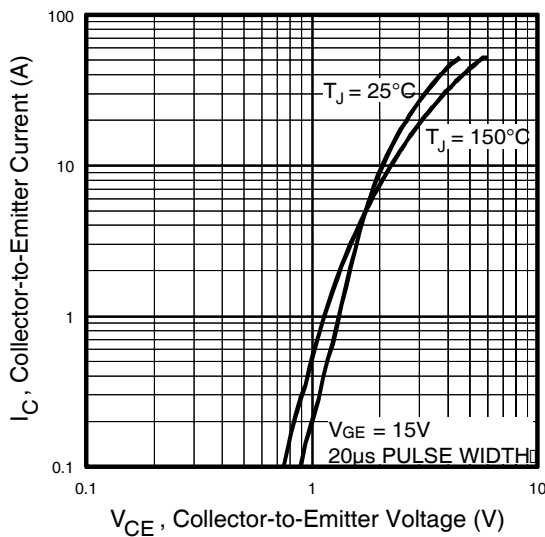
	Parameter	Min.	Typ.	Max.	Units	Conditions
$V_{(BR)CES}$	Collector-to-Emitter Breakdown Voltage <sup>③</sup>	600	----	----	V	$V_{GE} = 0V, I_C = 250\mu A$
$\Delta V_{(BR)CES}/\Delta T_J$	Temperature Coeff. of Breakdown Voltage	----	0.69	----	V/ $^\circ\text{C}$	$V_{GE} = 0V, I_C = 1.0mA$
$V_{CE(on)}$	Collector-to-Emitter Saturation Voltage	----	1.85	2.1	V	$I_C = 6.5A$ $V_{GE} = 15V$ $I_C = 13A$ $V_{GE} = 15V$ $I_C = 6.5A, T_J = 150^\circ\text{C}$ See Fig. 2, 5
		----	2.27	----		
		----	1.87	----		
$V_{GE(th)}$	Gate Threshold Voltage	3.0	----	6.0		$V_{CE} = V_{GE}, I_C = 250\mu A$
$\Delta V_{GE(th)}/\Delta T_J$	Temperature Coeff. of Threshold Voltage	----	-11	----	mV/ $^\circ\text{C}$	$V_{CE} = V_{GE}, I_C = 250\mu A$
$g_{fe}$	Forward Transconductance <sup>④</sup>	1.4	4.3	----	S	$V_{CE} = 100V, I_C = 6.5A$
$I_{CES}$	Zero Gate Voltage Collector Current	----	----	250	$\mu A$	$V_{GE} = 0V, V_{CE} = 600V$ $V_{GE} = 0V, V_{CE} = 600V, T_J = 150^\circ\text{C}$
		----	----	1700		
$V_{FM}$	Diode Forward Voltage Drop	----	1.4	1.7	V	$I_C = 8.0A$ $V_{GE} = 15V$ $I_C = 8.0A, T_J = 150^\circ\text{C}$ See Fig. 13
		----	1.3	1.6		
$I_{GES}$	Gate-to-Emitter Leakage Current	----	----	$\pm 100$	nA	$V_{GE} = \pm 20V$

## Switching Characteristics @ $T_J = 25^\circ\text{C}$ (unless otherwise specified)

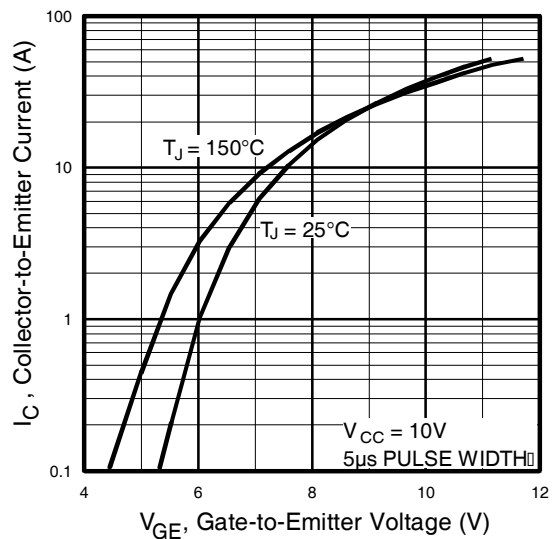
	Parameter	Min.	Typ.	Max.	Units	Conditions
$Q_g$	Total Gate Charge (turn-on)	----	27	41	nC	$I_C = 6.5A$ $V_{CC} = 400V$ $V_{GE} = 15V$ See Fig. 8
$Q_{ge}$	Gate - Emitter Charge (turn-on)	----	4.5	6.8		
$Q_{gc}$	Gate - Collector Charge (turn-on)	----	10	16		
$t_{d(on)}$	Turn-On Delay Time	----	39	----	ns	$T_J = 25^\circ\text{C}$ $I_C = 6.5A, V_{CC} = 480V$ $V_{GE} = 15V, R_G = 50\Omega$ Energy losses include "tail" and diode reverse recovery. See Fig. 9, 10, 11, 18
$t_r$	Rise Time	----	15	----		
$t_{d(off)}$	Turn-Off Delay Time	----	93	140		
$t_f$	Fall Time	----	110	170		
$E_{on}$	Turn-On Switching Loss	----	0.16	----	mJ	$T_J = 150^\circ\text{C}$ , $V_{CC} = 480V$ $I_C = 6.5A, V_{GE} = 15V, R_G = 50\Omega$ See Fig. 9, 10, 11, 18 Energy losses include "tail" and diode reverse recovery.
$E_{off}$	Turn-Off Switching Loss	----	0.13	----		
$E_{ts}$	Total Switching Loss	----	0.29	0.3		
$t_{d(on)}$	Turn-On Delay Time	----	38	----	ns	$T_J = 150^\circ\text{C}$ , $V_{CC} = 480V$ $I_C = 6.5A, V_{GE} = 15V, R_G = 50\Omega$ See Fig. 9, 10, 11, 18 Energy losses include "tail" and diode reverse recovery.
$t_r$	Rise Time	----	17	----		
$t_{d(off)}$	Turn-Off Delay Time	----	100	----		
$t_f$	Fall Time	----	220	----		
$E_{ts}$	Total Switching Loss	----	0.49	----	mJ	
$L_E$	Internal Emitter Inductance	----	7.5	----	nH	Measured 5mm from package
$C_{ies}$	Input Capacitance	----	530	----	pF	$V_{GE} = 0V$ $V_{CC} = 30V$ $f = 1.0MHz$ See Fig. 7
$C_{oes}$	Output Capacitance	----	39	----		
$C_{res}$	Reverse Transfer Capacitance	----	7.4	----		
$t_{rr}$	Diode Reverse Recovery Time	----	37	55	ns	$T_J = 25^\circ\text{C}$ See Fig. 14 $T_J = 125^\circ\text{C}$ 14
		----	55	90		
$I_{rr}$	Diode Peak Reverse Recovery Current	----	3.5	5.0	A	$T_J = 25^\circ\text{C}$ See Fig. 15 $T_J = 125^\circ\text{C}$ 15
		----	4.5	8.0		
$Q_{rr}$	Diode Reverse Recovery Charge	----	65	138	nC	$T_J = 25^\circ\text{C}$ See Fig. 16 $T_J = 125^\circ\text{C}$ 16
		----	124	360		
$di_{(rec)M}/dt$	Diode Peak Rate of Fall of Recovery During $t_b$	----	240	----	A/ $\mu s$	$T_J = 25^\circ\text{C}$ See Fig. 17 $T_J = 125^\circ\text{C}$ 17
		----	210	----		



**Fig. 1 - Typical Load Current vs. Frequency**  
 (Load Current =  $I_{\text{RMS}}$  of fundamental)

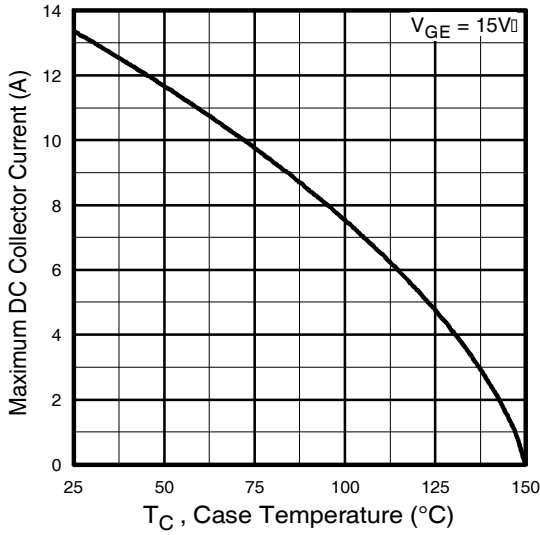


**Fig. 2 - Typical Output Characteristics**

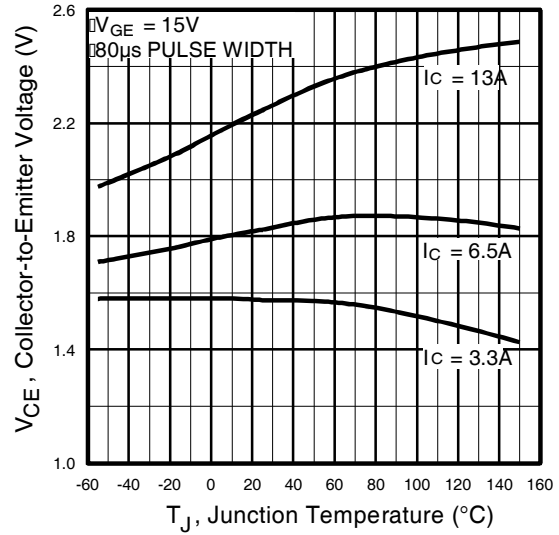


**Fig. 3 - Typical Transfer Characteristics**

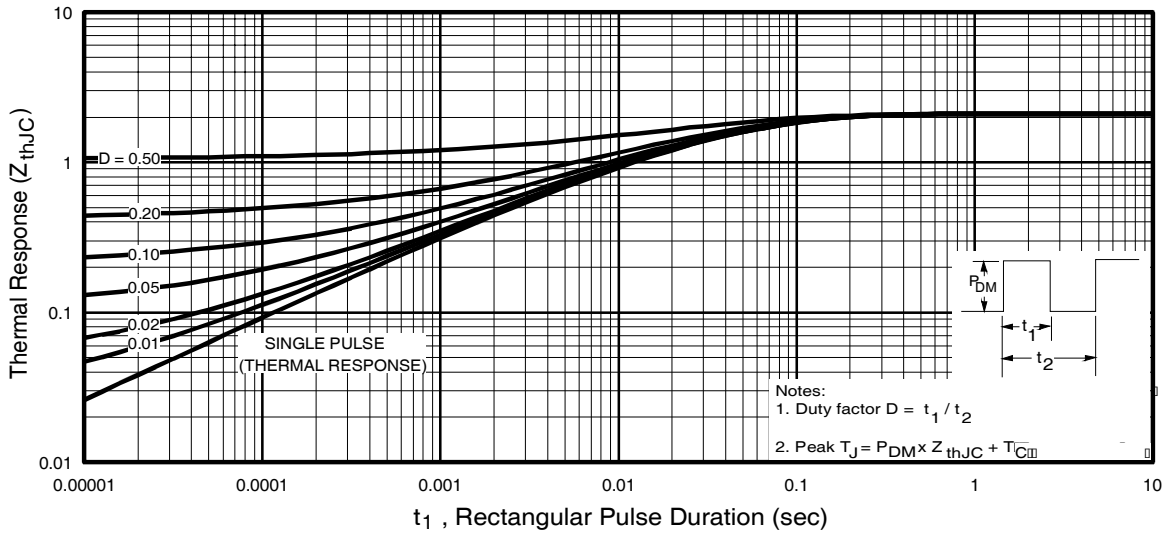
# IRG4BC20UDPbF



**Fig. 4 - Maximum Collector Current vs. Case Temperature**



**Fig. 5 - Typical Collector-to-Emitter Voltage vs. Junction Temperature**



**Fig. 6 - Maximum IGBT Effective Transient Thermal Impedance, Junction-to-Case**

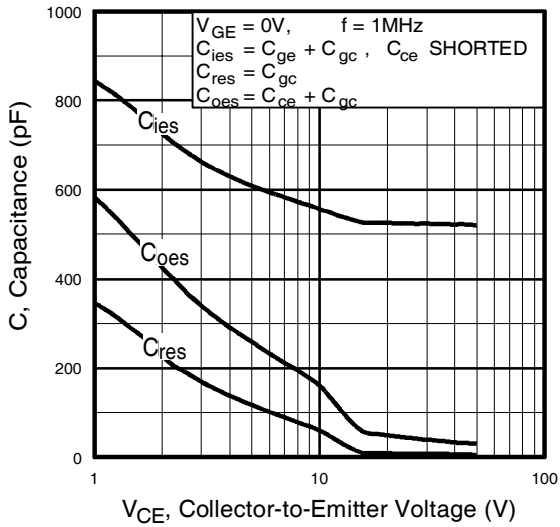


Fig. 7 - Typical Capacitance vs. Collector-to-Emitter Voltage

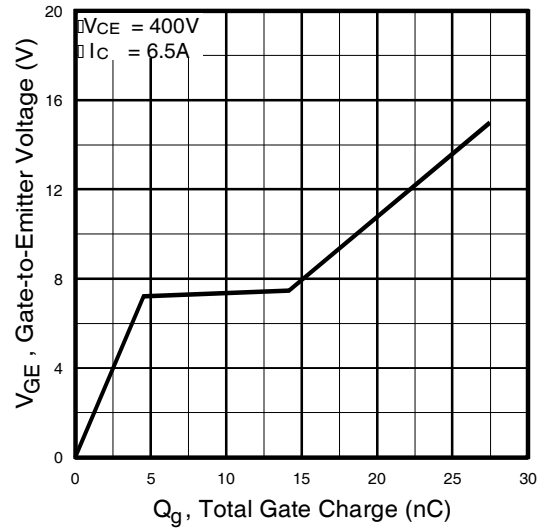


Fig. 8 - Typical Gate Charge vs. Gate-to-Emitter Voltage

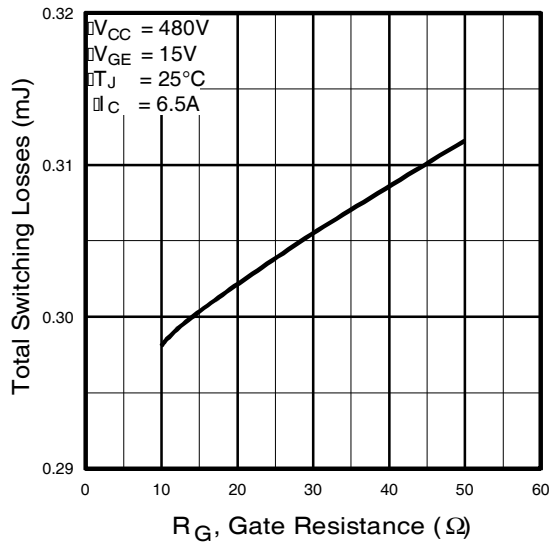


Fig. 9 - Typical Switching Losses vs. Gate Resistance

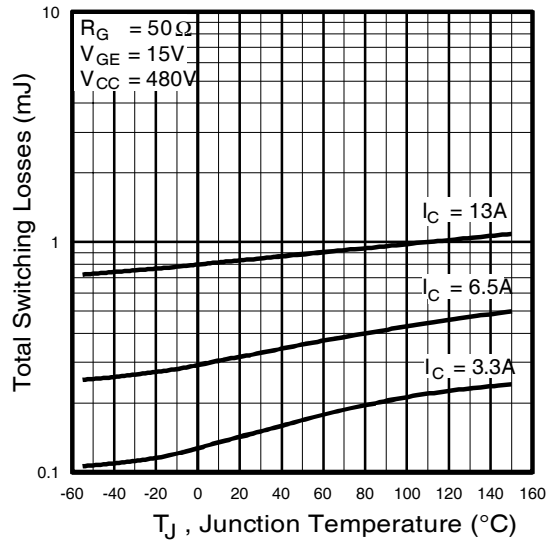
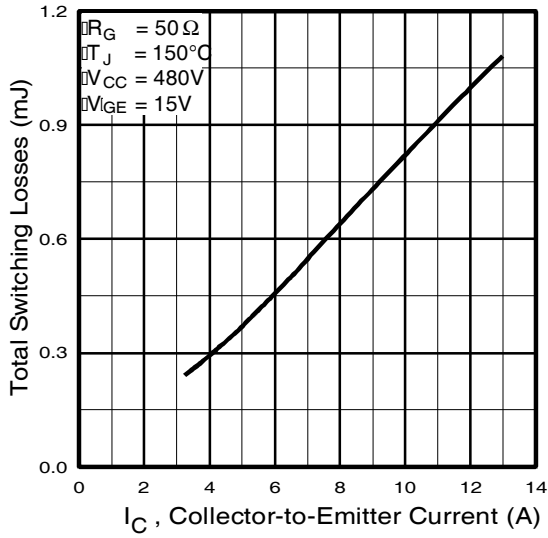
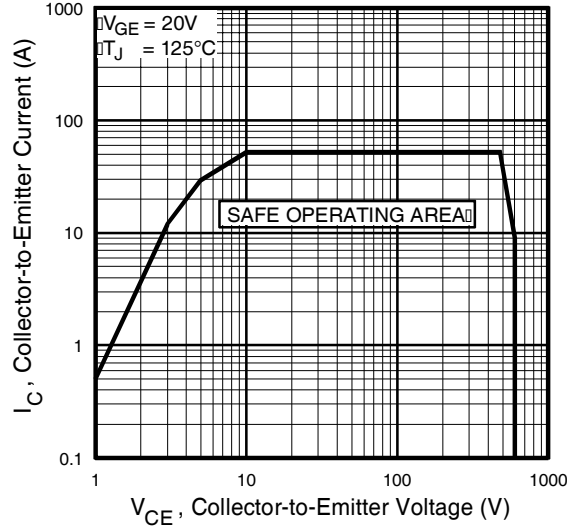


Fig. 10 - Typical Switching Losses vs. Junction Temperature

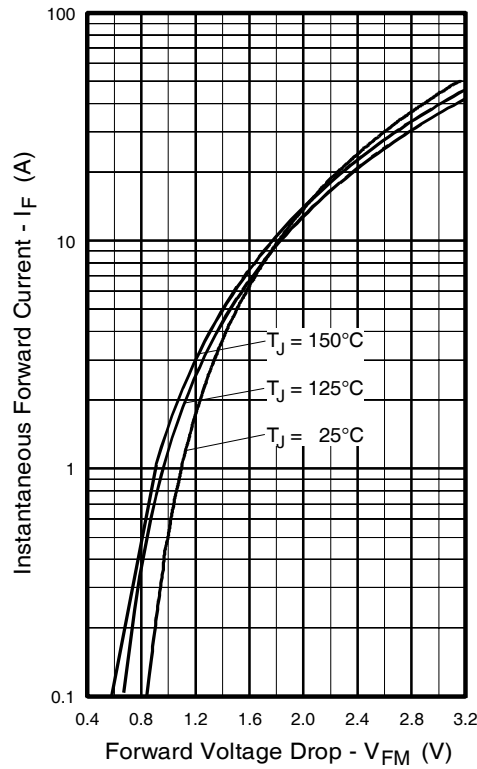
# IRG4BC20UDPbF



**Fig. 11** - Typical Switching Losses vs. Collector-to-Emitter Current



**Fig. 12** - Turn-Off SOA



**Fig. 13** - Maximum Forward Voltage Drop vs. Instantaneous Forward Current

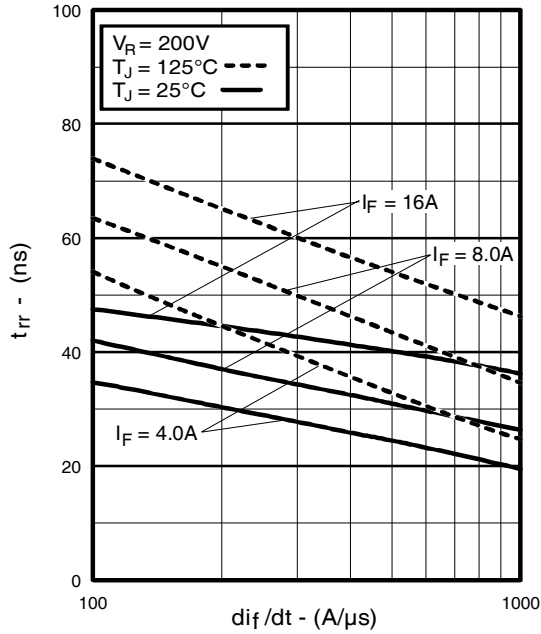


Fig. 14 - Typical Reverse Recovery vs.  $di_f/dt$

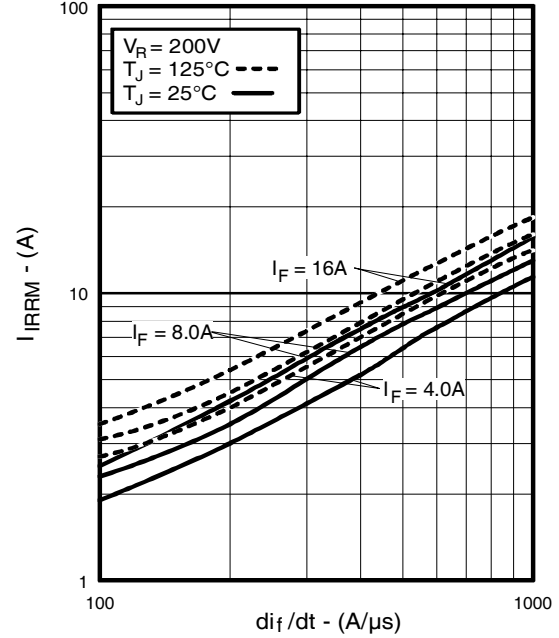


Fig. 15 - Typical Recovery Current vs.  $di_f/dt$

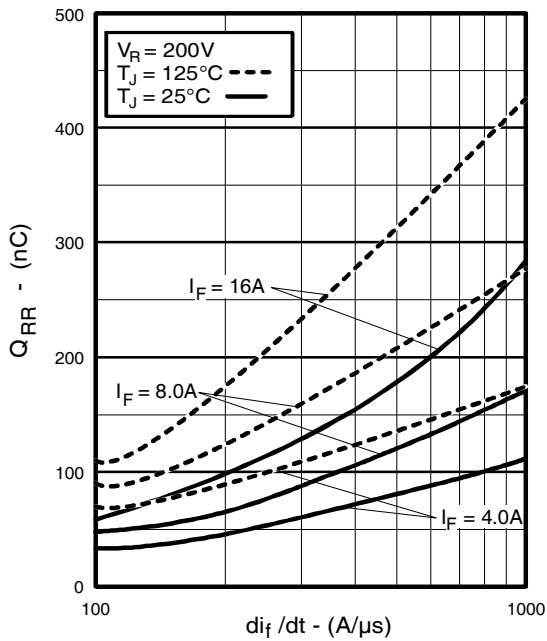


Fig. 16 - Typical Stored Charge vs.  $di_f/dt$   
www.irf.com

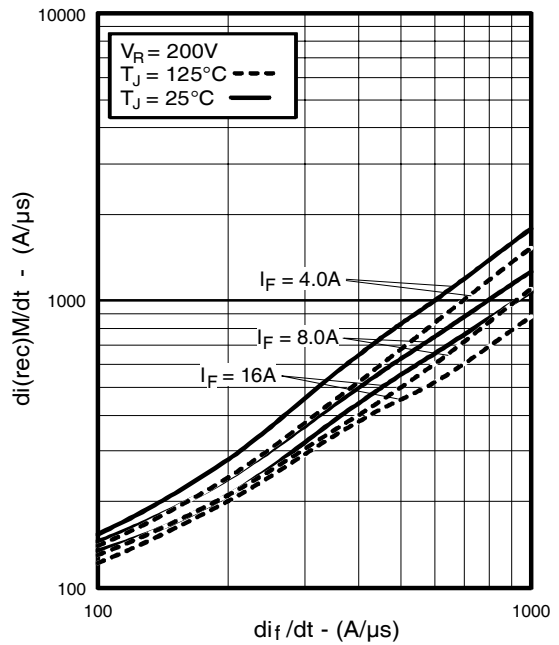
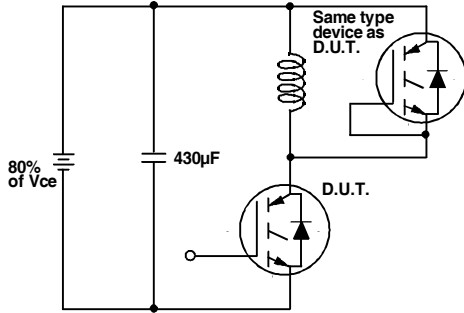
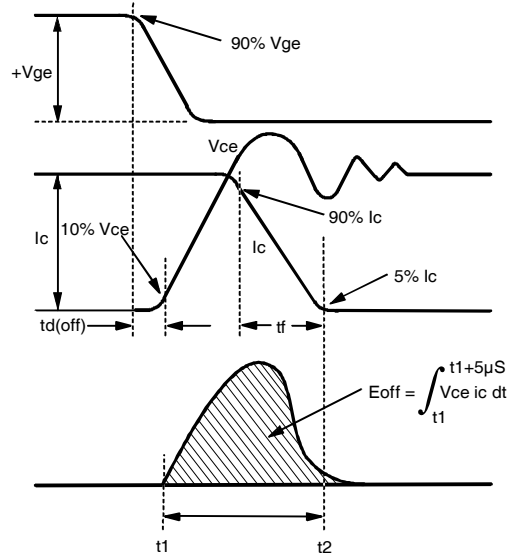


Fig. 17 - Typical  $di_{(rec)M}/dt$  vs.  $di_f/dt$

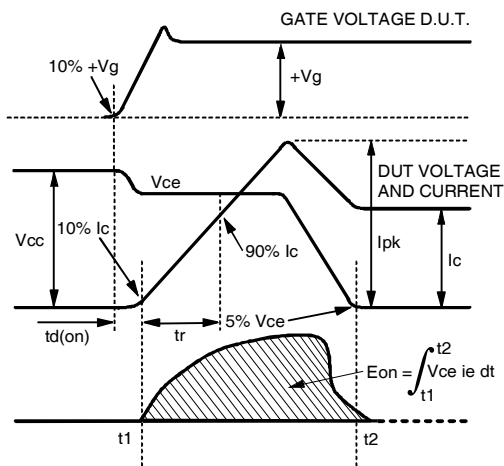
# IRG4BC20UDPbF



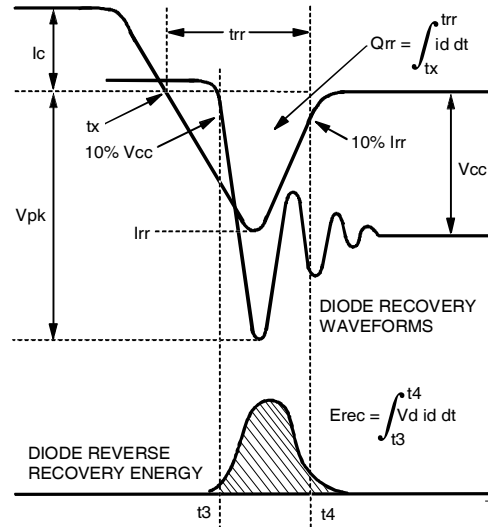
**Fig. 18a** - Test Circuit for Measurement of  $I_{LM}$ ,  $E_{on}$ ,  $E_{off}(\text{diode})$ ,  $t_{rr}$ ,  $Q_{rr}$ ,  $I_{rr}$ ,  $t_{d(on)}$ ,  $t_r$ ,  $t_{d(off)}$ ,  $t_f$



**Fig. 18b** - Test Waveforms for Circuit of Fig. 18a, Defining  $E_{off}$ ,  $t_{d(off)}$ ,  $t_f$



**Fig. 18c** - Test Waveforms for Circuit of Fig. 18a, Defining  $E_{on}$ ,  $t_{d(on)}$ ,  $t_r$



**Fig. 18d** - Test Waveforms for Circuit of Fig. 18a, Defining  $E_{rec}$ ,  $t_{rr}$ ,  $Q_{rr}$ ,  $I_{rr}$



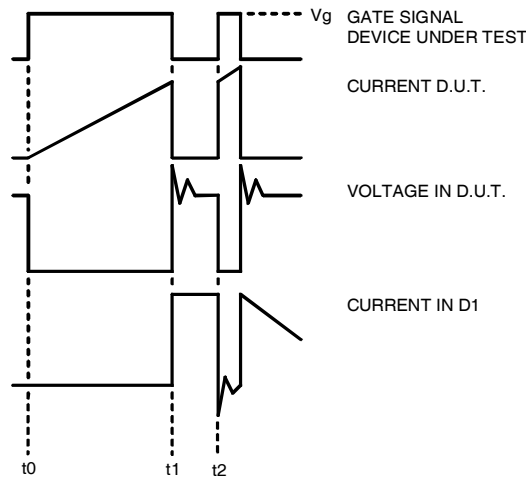


Figure 18e. Macro Waveforms for Figure 18a's Test Circuit

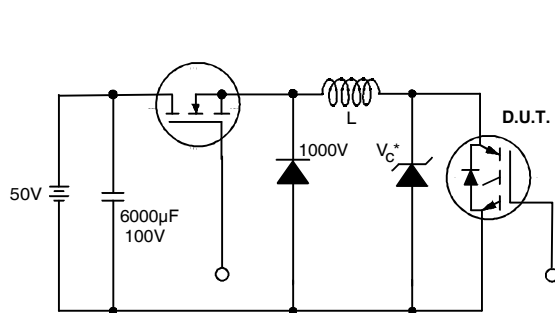
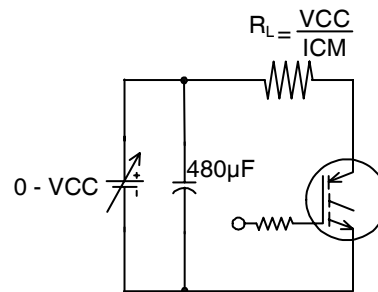


Figure 19. Clamped Inductive Load Test Circuit



Pulsed Collector Current  
 Test Circuit

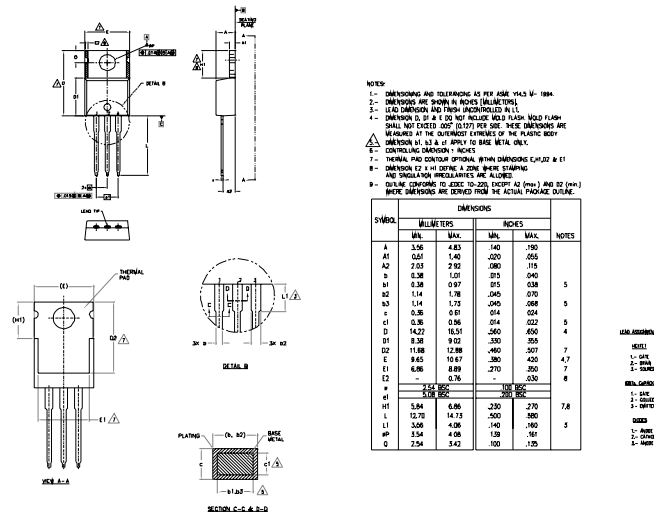
Figure 20. Pulsed Collector Current  
 Test Circuit

# IRG4BC20UDPbF

## Notes:

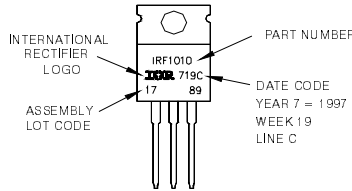
- ① Repetitive rating:  $V_{GE}=20V$ ; pulse width limited by maximum junction temperature (figure 20)
- ②  $V_{CC}=80\%(V_{CES})$ ,  $V_{GE}=20V$ ,  $L=10\mu H$ ,  $R_G=50\Omega$  (figure 19)
- ③ Pulse width  $\leq 80\mu s$ ; duty factor  $\leq 0.1\%$ .
- ④ Pulse width  $5.0\mu s$ , single shot.

## TO-220AB Package Outline (Dimensions are shown in millimeters (inches))



## TO-220AB Part Marking Information

EXAMPLE: THIS IS AN IRF1010  
 LOT CODE 1789  
 ASSEMBLED ON WW 19, 1997  
 IN THE ASSEMBLY LINE 'C'  
**Note:** "P" in assembly line  
 position indicates "Lead-Free"



Note: For the most current drawing please refer to IR website at <http://www.irf.com/package/>

Data and specifications subject to change without notice.

单击下面可查看定价，库存，交付和生命周期等信息

[>>Infineon Technologies\(英飞凌\)](#)