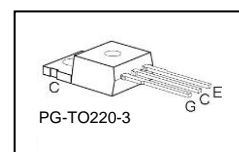
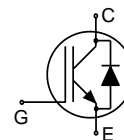


Low Loss DuoPack : IGBT in TRENCHSTOP™ and Fieldstop technology with soft, fast recovery anti-parallel Emitter Controlled HE diode


Features:

- Very low $V_{CE(sat)}$ 1.5V (typ.)
- Maximum Junction Temperature 175°C
- Short circuit withstand time 5 μ s
- Designed for :
 - Frequency Converters
 - Uninterrupted Power Supply
- TRENCHSTOP™ and Fieldstop technology for 600V applications offers :
 - very tight parameter distribution
 - high ruggedness, temperature stable behavior
 - very high switching speed
 - low $V_{CE(sat)}$
- Positive temperature coefficient in $V_{CE(sat)}$
- Low EMI
- Low Gate Charge
- Very soft, fast recovery anti-parallel Emitter Controlled HE diode
- Qualified according to JEDEC¹ for target applications
- Pb-free lead plating; RoHS compliant
- Complete product spectrum and PSpice Models : <http://www.infineon.com/igbt/>



Type	V_{CE}	I_C	$V_{CE(sat), T_j=25^\circ C}$	$T_{j,max}$	Marking	Package
IKP20N60T	600V	20A	1.5V	175°C	K20T60	PG-TO220-3

Maximum Ratings

Parameter	Symbol	Value	Unit	
Collector-emitter voltage, $T_j \geq 25^\circ C$	V_{CE}	600	V	
DC collector current, limited by $T_{j,max}$	I_C	$T_C = 25^\circ C$	41	
		$T_C = 100^\circ C$	28	
Pulsed collector current, t_p limited by $T_{j,max}$	$I_{C,puls}$	60	A	
Turn off safe operating area, $V_{CE} = 600V$, $T_j = 175^\circ C$, $t_p = 1\mu s$	-	60		
Diode forward current, limited by $T_{j,max}$	I_F	$T_C = 25^\circ C$		41
		$T_C = 100^\circ C$		28
Diode pulsed current, t_p limited by $T_{j,max}$	$I_{F,puls}$	60		
Gate-emitter voltage	V_{GE}	± 20	V	
Short circuit withstand time ²⁾	t_{SC}	5	μs	
$V_{GE} = 15V$, $V_{CC} \leq 400V$, $T_j \leq 150^\circ C$				
Power dissipation $T_C = 25^\circ C$	P_{tot}	166	W	
Operating junction temperature	T_j	-40...+175	°C	
Storage temperature	T_{stg}	-55...+150		
Soldering temperature, 1.6mm (0.063 in.) from case for 10s	-	260		

¹ J-STD-020 and JESD-022

²⁾ Allowed number of short circuits: <1000; time between short circuits: >1s.

Thermal Resistance

Parameter	Symbol	Conditions	Max. Value	Unit
Characteristic				
IGBT thermal resistance, junction – case	R_{thJC}		0.9	K/W
Diode thermal resistance, junction – case	R_{thJCD}		1.5	
Thermal resistance, junction – ambient	R_{thJA}		62	

Electrical Characteristic, at $T_j = 25^\circ\text{C}$, unless otherwise specified

Parameter	Symbol	Conditions	Value			Unit
			min.	Typ.	max.	
Static Characteristic						
Collector-emitter breakdown voltage	$V_{(BR)CES}$	$V_{GE}=0V, I_C=0.2mA$	600	-	-	V
Collector-emitter saturation voltage	$V_{CE(sat)}$	$V_{GE} = 15V, I_C=20A$ $T_j=25^\circ\text{C}$ $T_j=175^\circ\text{C}$	-	1.5	2.05	
Diode forward voltage	V_F	$V_{GE}=0V, I_F=20A$ $T_j=25^\circ\text{C}$ $T_j=175^\circ\text{C}$	-	1.65	2.05	
Gate-emitter threshold voltage	$V_{GE(th)}$	$I_C=290\mu A, V_{CE}=V_{GE}$	4.1	4.9	5.7	
Zero gate voltage collector current	I_{CES}	$V_{CE}=600V,$ $V_{GE}=0V$ $T_j=25^\circ\text{C}$ $T_j=175^\circ\text{C}$	-	-	40	μA
Gate-emitter leakage current	I_{GES}	$V_{CE}=0V, V_{GE}=20V$	-	-	100	
Transconductance	g_{fs}	$V_{CE}=20V, I_C=20A$	-	11	-	S
Integrated gate resistor	R_{Gint}			-		Ω

Dynamic Characteristic

Input capacitance	C_{iss}	$V_{CE}=25V,$ $V_{GE}=0V,$ $f=1MHz$	-	1100	-	μF
Output capacitance	C_{oss}		-	71	-	
Reverse transfer capacitance	C_{riss}		-	32	-	
Gate charge	Q_{Gate}	$V_{CC}=480V, I_C=20A$ $V_{GE}=15V$	-	120	-	nC
Internal emitter inductance measured 5mm (0.197 in.) from case	L_E	PG-TO220-3	-	7	-	nH
Short circuit collector current ¹⁾	$I_{C(SC)}$	$V_{GE}=15V, t_{SC}\leq 5\mu s$ $V_{CC} = 400V,$ $T_j \leq 150^\circ\text{C}$	-	183.3	-	A

¹⁾ Allowed number of short circuits: <1000; time between short circuits: >1s.

Switching Characteristic, Inductive Load, at $T_j=25^\circ\text{C}$

Parameter	Symbol	Conditions	Value			Unit
			min.	Typ.	max.	
IGBT Characteristic						
Turn-on delay time	$t_{d(on)}$	$T_j=25^\circ\text{C}$, $V_{CC}=400\text{V}$, $I_C=20\text{A}$, $V_{GE}=0/15\text{V}$, $r_G=12\Omega$, $L_\sigma=131\text{nH}$, $C_\sigma=31\text{pF}$	-	18	-	ns
Rise time	t_r		-	14	-	
Turn-off delay time	$t_{d(off)}$		-	199	-	
Fall time	t_f		-	42	-	
Turn-on energy	E_{on}	L_σ , C_σ from Fig. E Energy losses include "tail" and diode reverse recovery.	-	0.31	-	mJ
Turn-off energy	E_{off}		-	0.46	-	
Total switching energy	E_{ts}		-	0.77	-	
Anti-Parallel Diode Characteristic						
Diode reverse recovery time	t_{rr}	$T_j=25^\circ\text{C}$,	-	41	-	ns
Diode reverse recovery charge	Q_{rr}	$V_R=400\text{V}$, $I_F=20\text{A}$,	-	0.31	-	μC
Diode peak reverse recovery current	I_{rrm}	$di_F/dt=880\text{A}/\mu\text{s}$	-	13.3	-	A
Diode peak rate of fall of reverse recovery current during t_b	di_{rr}/dt		-	711	-	$\text{A}/\mu\text{s}$

Switching Characteristic, Inductive Load, at $T_j=175^\circ\text{C}$

Parameter	Symbol	Conditions	Value			Unit
			min.	Typ.	max.	
IGBT Characteristic						
Turn-on delay time	$t_{d(on)}$	$T_j=175^\circ\text{C}$, $V_{CC}=400\text{V}$, $I_C=20\text{A}$, $V_{GE}=0/15\text{V}$, $r_G=12\Omega$, $L_\sigma=131\text{nH}$, $C_\sigma=31\text{pF}$	-	18	-	ns
Rise time	t_r		-	18	-	
Turn-off delay time	$t_{d(off)}$		-	223	-	
Fall time	t_f		-	76	-	
Turn-on energy	E_{on}	L_σ , C_σ from Fig. E Energy losses include "tail" and diode reverse recovery.	-	0.51	-	mJ
Turn-off energy	E_{off}		-	0.64	-	
Total switching energy	E_{ts}		-	1.15	-	
Anti-Parallel Diode Characteristic						
Diode reverse recovery time	t_{rr}	$T_j=175^\circ\text{C}$	-	176	-	ns
Diode reverse recovery charge	Q_{rr}	$V_R=400\text{V}$, $I_F=20\text{A}$,	-	1.46	-	μC
Diode peak reverse recovery current	I_{rrm}	$di_F/dt=880\text{A}/\mu\text{s}$	-	18.9	-	A
Diode peak rate of fall of reverse recovery current during t_b	di_{rr}/dt		-	467	-	$\text{A}/\mu\text{s}$

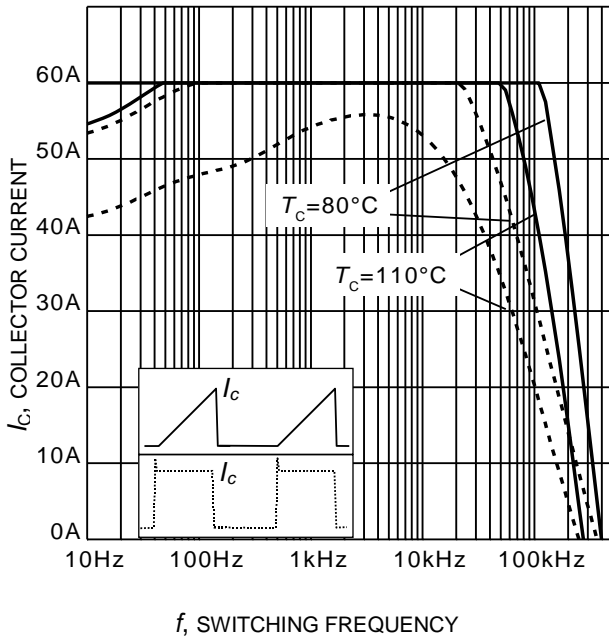


Figure 1. Collector current as a function of switching frequency
 ($T_j \leq 175^\circ\text{C}$, $D = 0.5$, $V_{CE} = 400\text{V}$,
 $V_{GE} = 0/15\text{V}$, $r_G = 12\Omega$)

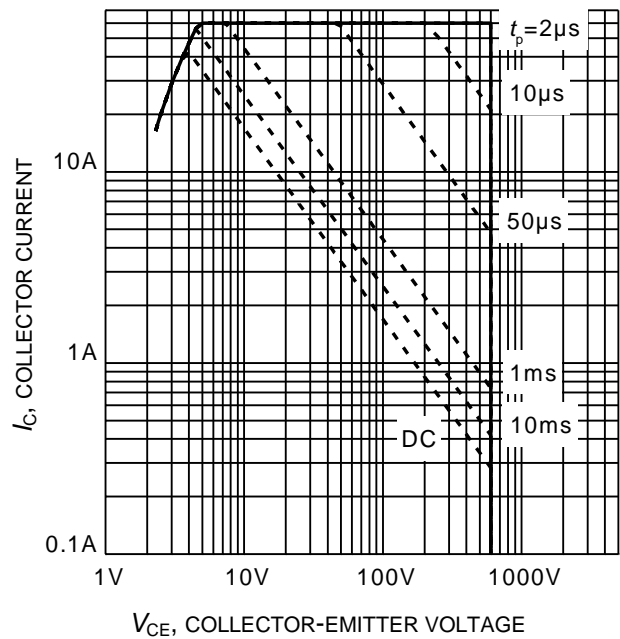


Figure 2. Safe operating area
 ($D = 0$, $T_C = 25^\circ\text{C}$, $T_j \leq 175^\circ\text{C}$;
 $V_{GE} = 0/15\text{V}$)



Figure 3. Power dissipation as a function of case temperature
 ($T_j \leq 175^\circ\text{C}$)

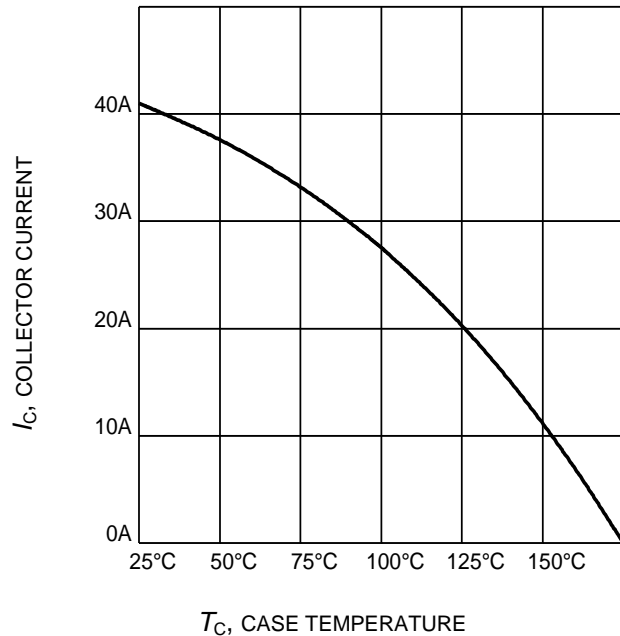


Figure 4. Collector current as a function of case temperature
 ($V_{GE} \geq 15\text{V}$, $T_j \leq 175^\circ\text{C}$)



Figure 5. Typical output characteristic
($T_j = 25^\circ\text{C}$)



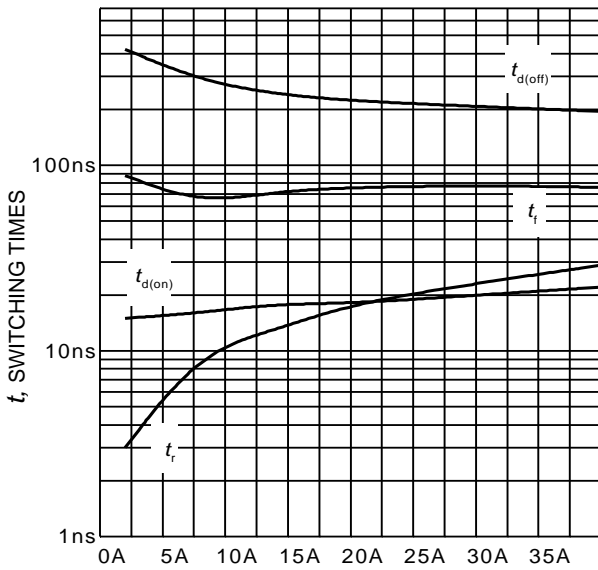
Figure 6. Typical output characteristic
($T_j = 175^\circ\text{C}$)



Figure 7. Typical transfer characteristic
($V_{CE} = 10\text{V}$)

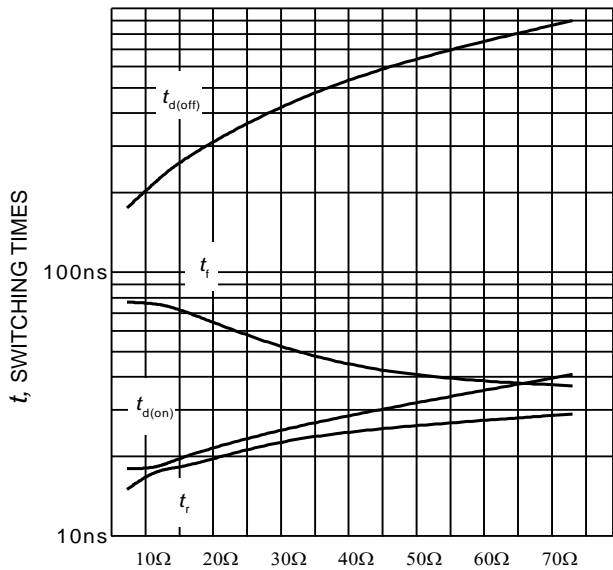


Figure 8. Typical collector-emitter saturation voltage as a function of junction temperature
($V_{GE} = 15\text{V}$)



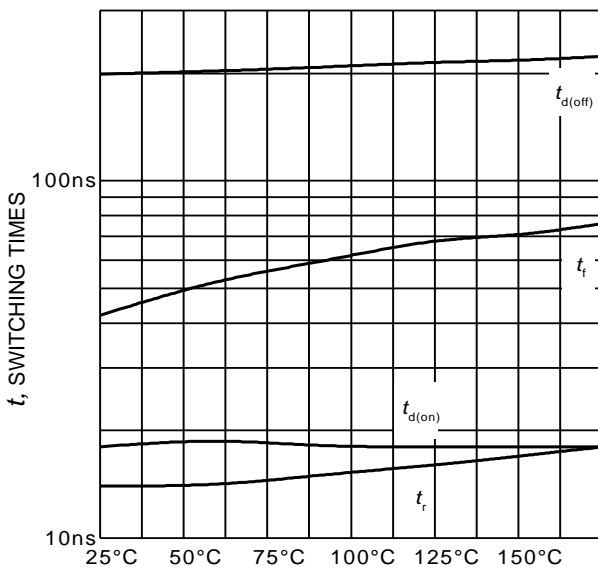
I_C , COLLECTOR CURRENT

Figure 9. Typical switching times as a function of collector current
(inductive load, $T_J=175^\circ\text{C}$,
 $V_{CE} = 400\text{V}$, $V_{GE} = 0/15\text{V}$, $r_G = 12\Omega$,
Dynamic test circuit in Figure E)



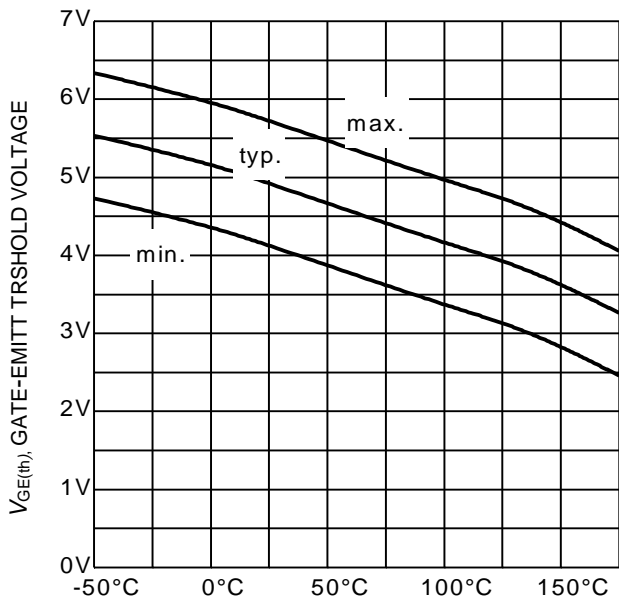
R_G , GATE RESISTOR

Figure 10. Typical switching times as a function of gate resistor
(inductive load, $T_J = 175^\circ\text{C}$,
 $V_{CE}= 400\text{V}$, $V_{GE} = 0/15\text{V}$, $I_C = 20\text{A}$,
Dynamic test circuit in Figure E)



T_J , JUNCTION TEMPERATURE

Figure 11. Typical switching times as a function of junction temperature
(inductive load, $V_{CE} = 400\text{V}$,
 $V_{GE} = 0/15\text{V}$, $I_C = 20\text{A}$, $r_G=12\Omega$,
Dynamic test circuit in Figure E)



T_J , JUNCTION TEMPERATURE

Figure 12. Gate-emitter threshold voltage as a function of junction temperature
($I_C = 0.29\text{mA}$)

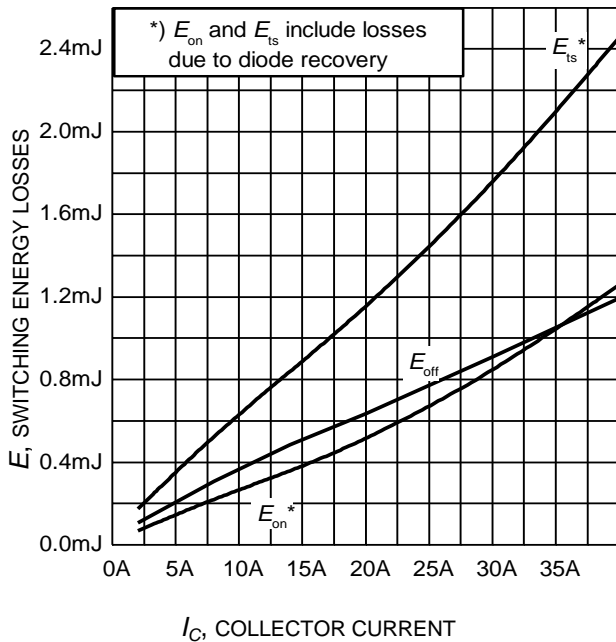


Figure 13. Typical switching energy losses as a function of collector current
(inductive load, $T_J = 175^\circ\text{C}$, $V_{CE} = 400\text{V}$, $V_{GE} = 0/15\text{V}$, $r_G = 12\Omega$, Dynamic test circuit in Figure E)

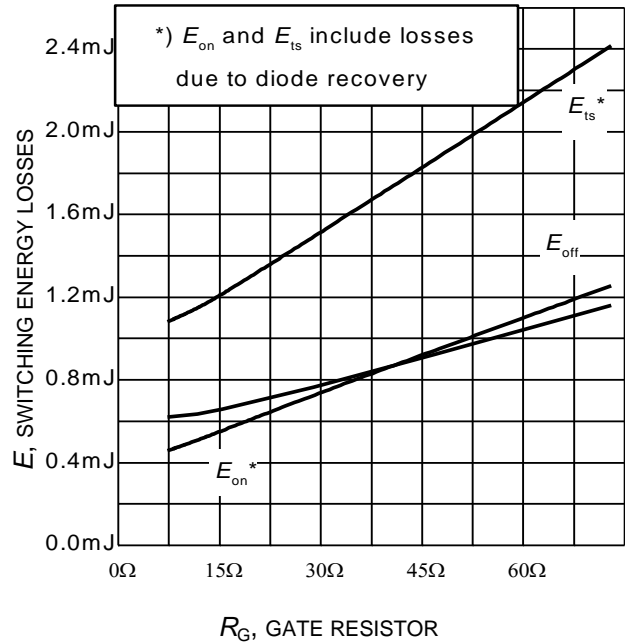


Figure 14. Typical switching energy losses as a function of gate resistor
(inductive load, $T_J = 175^\circ\text{C}$, $V_{CE} = 400\text{V}$, $V_{GE} = 0/15\text{V}$, $I_C = 20\text{A}$, Dynamic test circuit in Figure E)



Figure 15. Typical switching energy losses as a function of junction temperature
(inductive load, $V_{CE} = 400\text{V}$, $V_{GE} = 0/15\text{V}$, $I_C = 20\text{A}$, $r_G = 12\Omega$, Dynamic test circuit in Figure E)

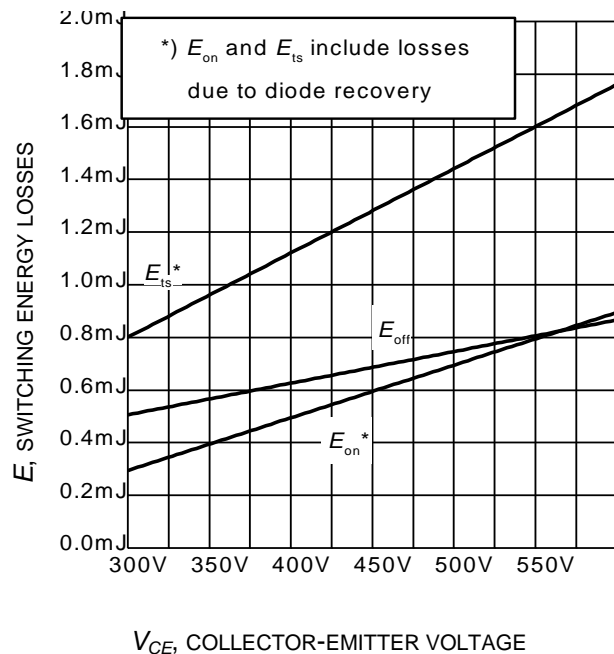


Figure 16. Typical switching energy losses as a function of collector emitter voltage
(inductive load, $T_J = 175^\circ\text{C}$, $V_{GE} = 0/15\text{V}$, $I_C = 20\text{A}$, $r_G = 12\Omega$, Dynamic test circuit in Figure E)

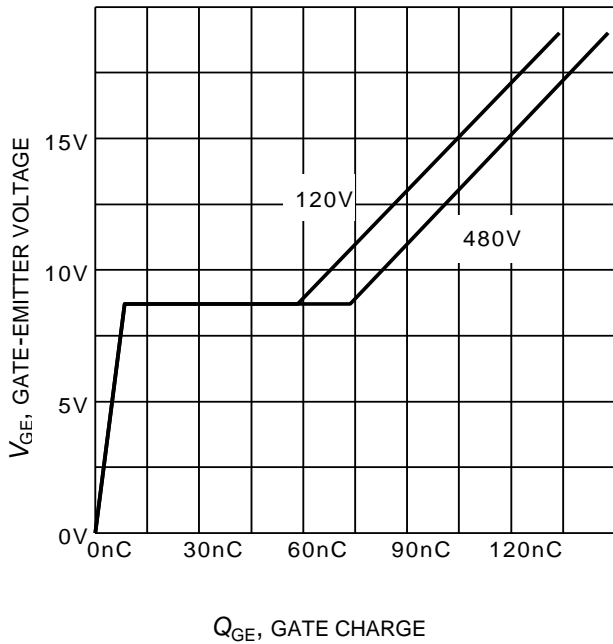


Figure 17. Typical gate charge
($I_C=20\text{ A}$)



Figure 18. Typical capacitance as a function of collector-emitter voltage
($V_{GE}=0\text{V}$, $f = 1\text{ MHz}$)

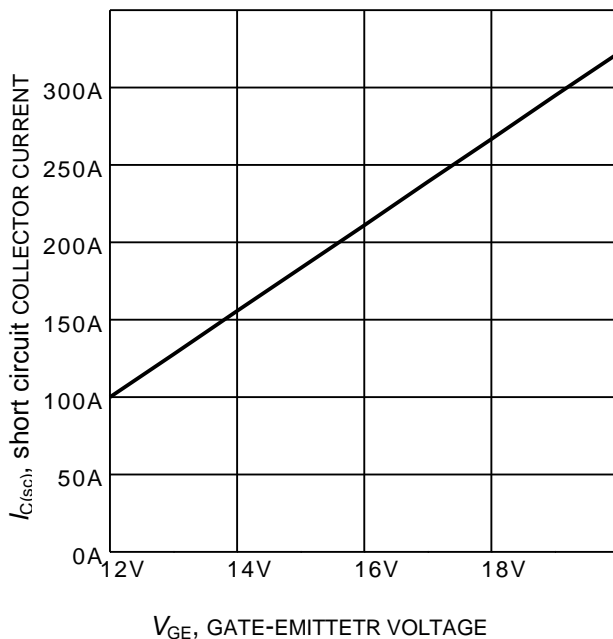


Figure 19. Typical short circuit collector current as a function of gate-emitter voltage
($V_{CE} \leq 400\text{V}$, $T_J \leq 150^\circ\text{C}$)

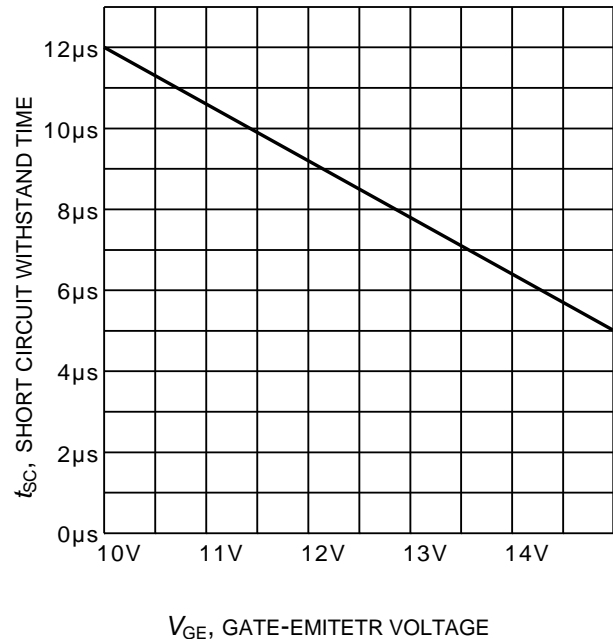


Figure 20. Short circuit withstand time as a function of gate-emitter voltage
($V_{CE}=400\text{V}$, start at $T_J=25^\circ\text{C}$, $T_{Jmax}<150^\circ\text{C}$)

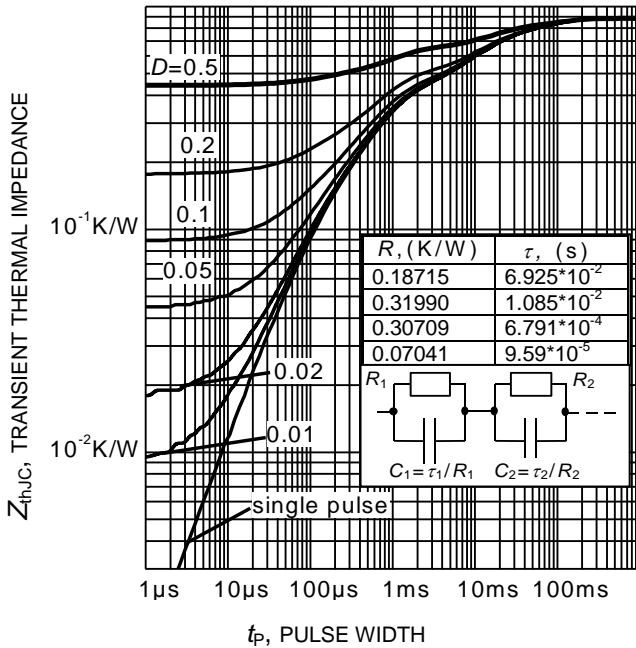


Figure 21. IGBT transient thermal impedance
($D = t_p / T$)

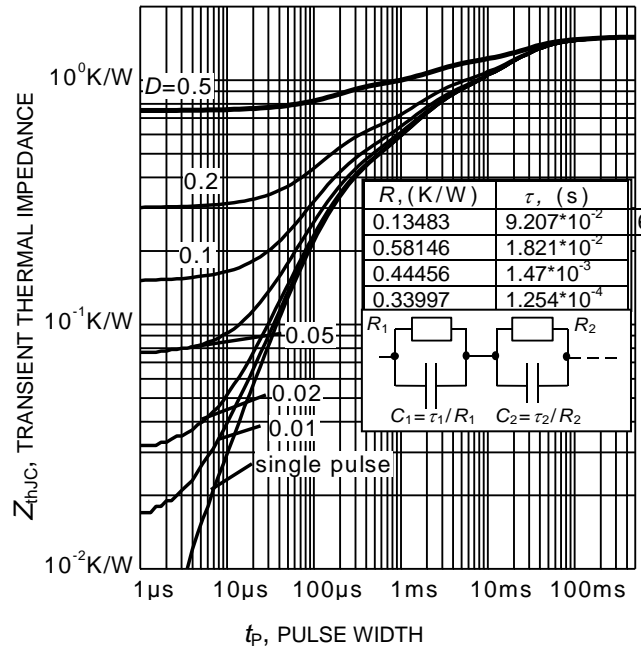


Figure 22. Diode transient thermal impedance as a function of pulse width
($D = t_p / T$)

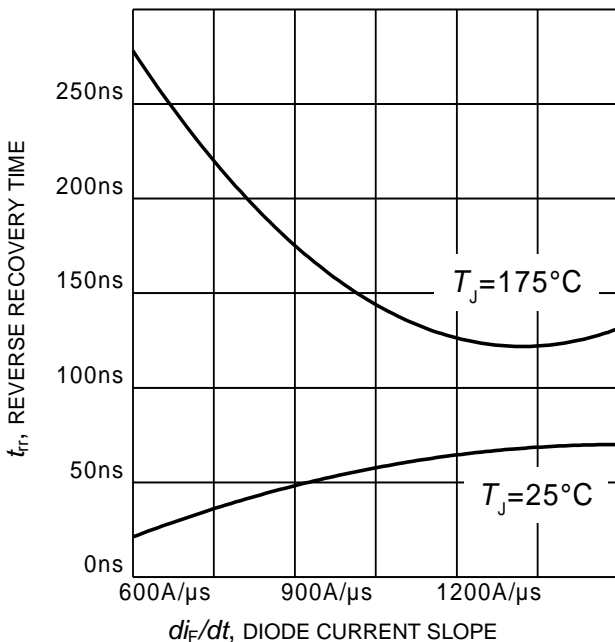


Figure 23. Typical reverse recovery time as a function of diode current slope
($V_R = 400V$, $I_F = 20A$,
Dynamic test circuit in Figure E)

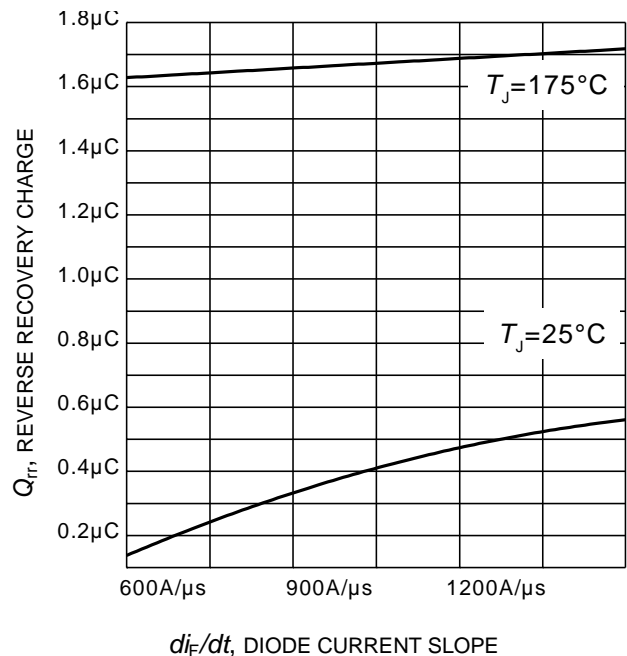
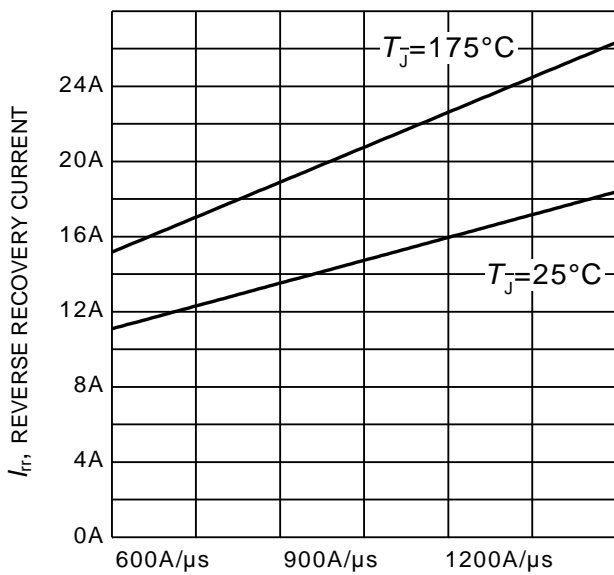


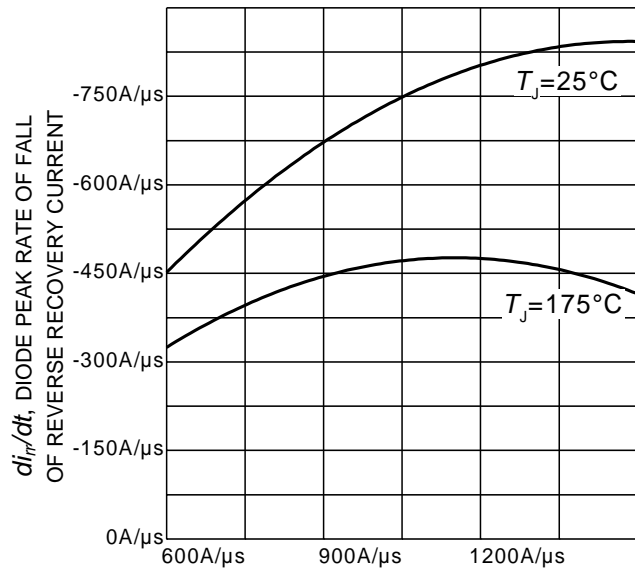
Figure 24. Typical reverse recovery charge as a function of diode current slope
($V_R = 400V$, $I_F = 20A$,
Dynamic test circuit in Figure E)



di_F/dt , DIODE CURRENT SLOPE

Figure 25. Typical reverse recovery current as a function of diode current slope

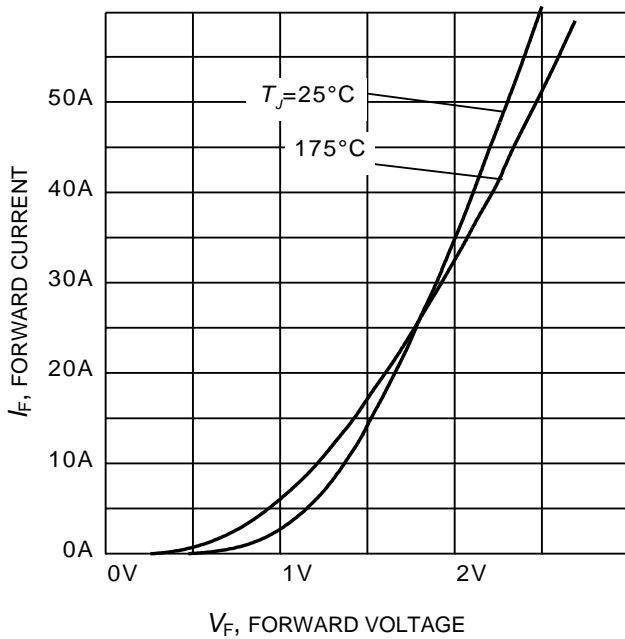
($V_R = 400V$, $I_F = 20A$,
Dynamic test circuit in Figure E)



di_F/dt , DIODE CURRENT SLOPE

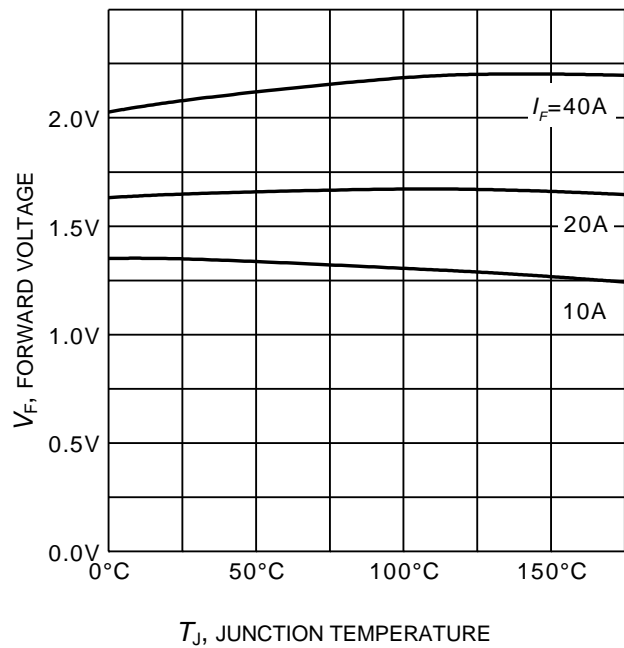
Figure 26. Typical diode peak rate of fall of reverse recovery current as a function of diode current slope

($V_R = 400V$, $I_F = 20A$,
Dynamic test circuit in Figure E)



V_F , FORWARD VOLTAGE

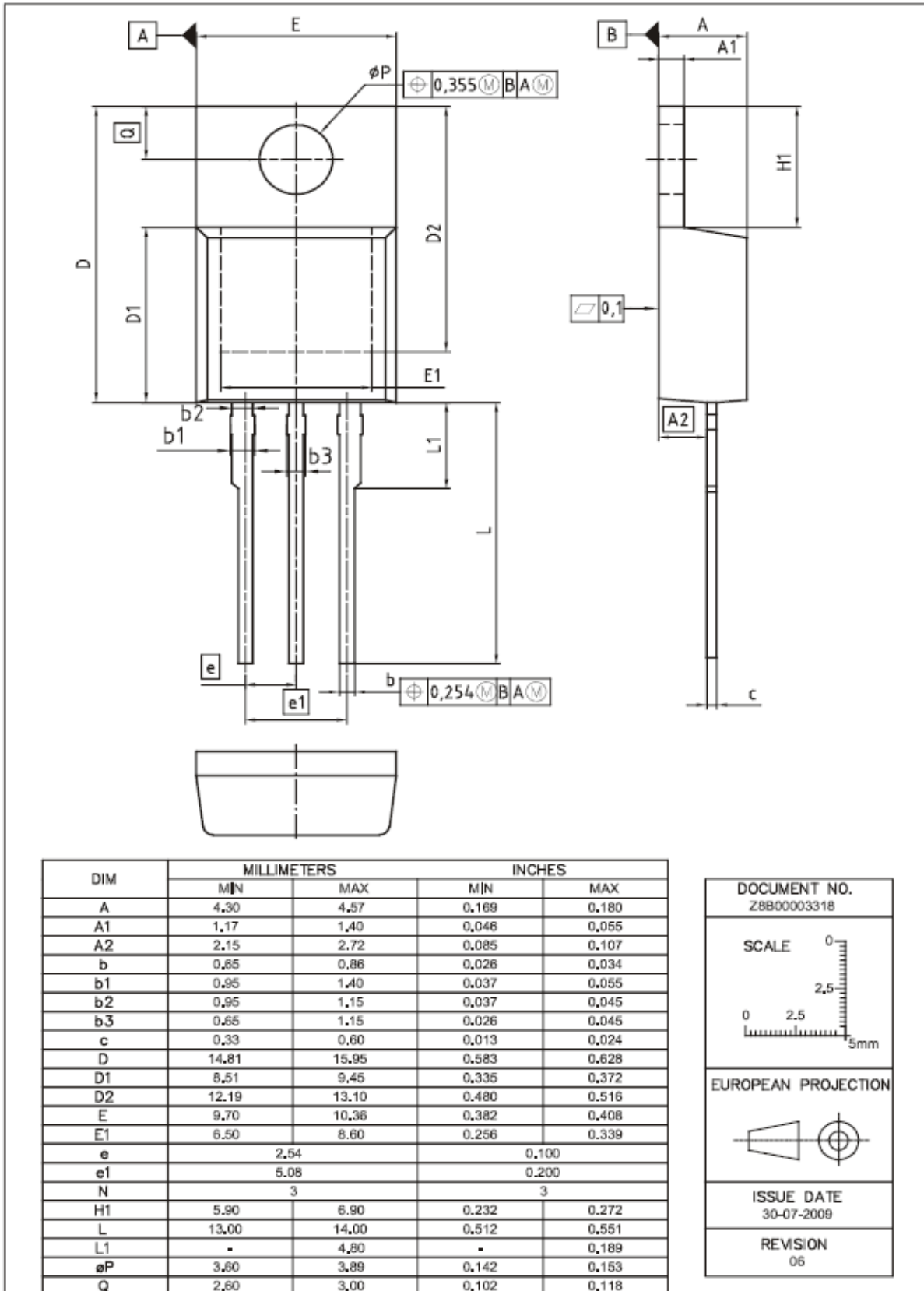
Figure 27. Typical diode forward current as a function of forward voltage



T_J , JUNCTION TEMPERATURE

Figure 28. Typical diode forward voltage as a function of junction temperature

PG-TO220-3



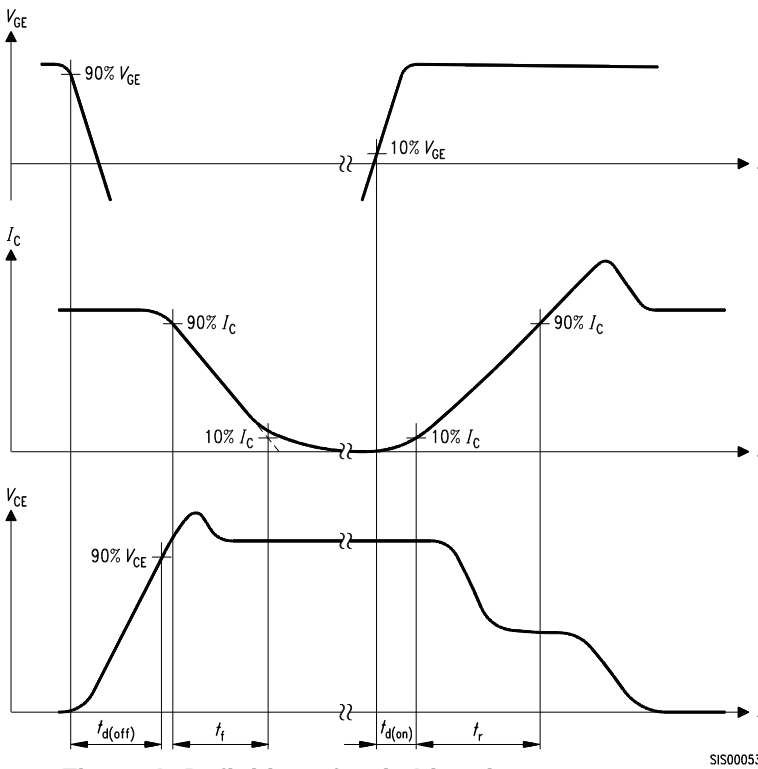


Figure A. Definition of switching times

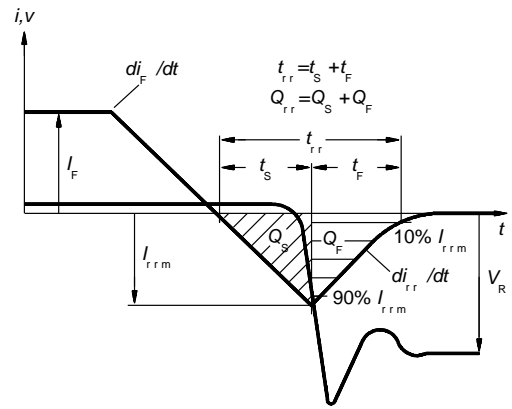


Figure C. Definition of diodes switching characteristics

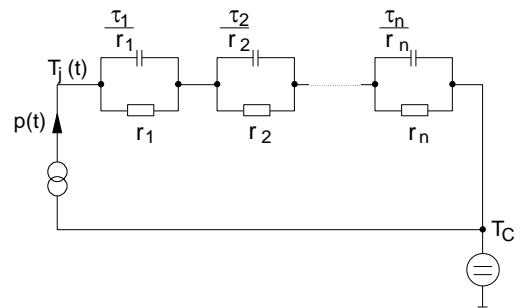


Figure D. Thermal equivalent circuit

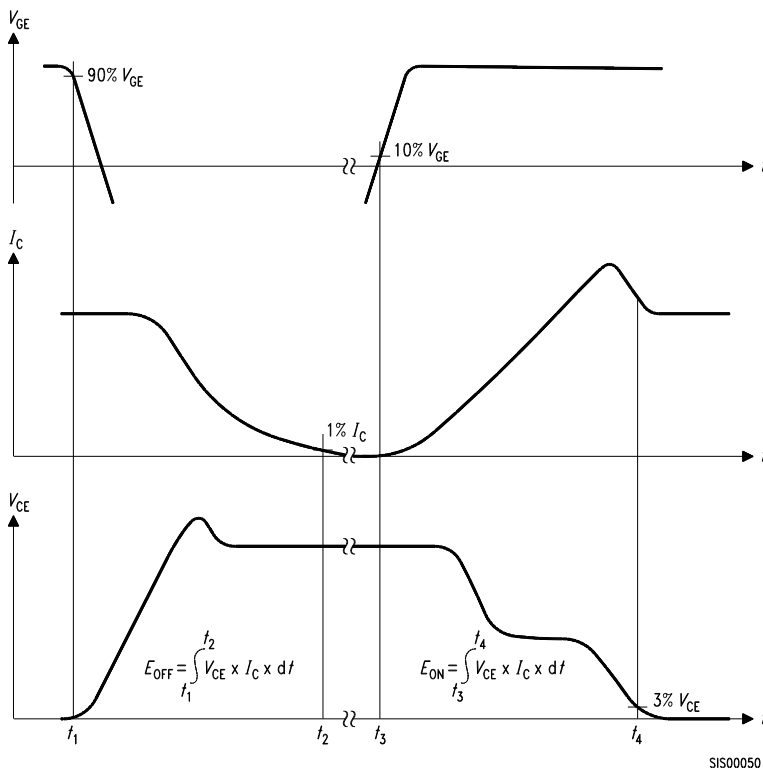


Figure B. Definition of switching losses

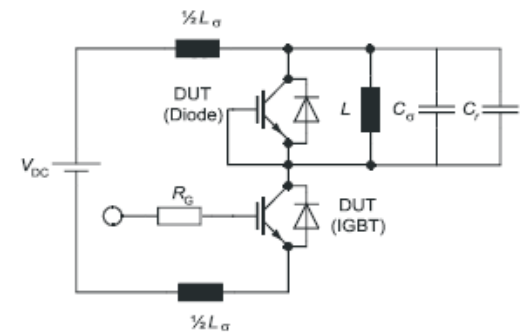


Figure E. Dynamic test circuit
Parasitic inductance L_σ ,
Parasitic capacitor C_σ ,
Relief capacitor C_r
(only for ZVT switching)

Published by
Infineon Technologies AG
81726 Munich, Germany
© 2015 Infineon Technologies AG
All Rights Reserved.

Legal Disclaimer

The information given in this document shall in no event be regarded as a guarantee of conditions or characteristics. With respect to any examples or hints given herein, any typical values stated herein and/or any information regarding the application of the device, Infineon Technologies hereby disclaims any and all warranties and liabilities of any kind, including without limitation, warranties of non-infringement of intellectual property rights of any third party.

Information

For further information on technology, delivery terms and conditions and prices, please contact the nearest Infineon Technologies Office (www.infineon.com).

Warnings

Due to technical requirements, components may contain dangerous substances. For information on the types in question, please contact the nearest Infineon Technologies Office.

The Infineon Technologies component described in this Data Sheet may be used in life-support devices or systems and/or automotive, aviation and aerospace applications or systems only with the express written approval of Infineon Technologies, if a failure of such components can reasonably be expected to cause the failure of that life-support, automotive, aviation and aerospace device or system or to affect the safety or effectiveness of that device or system. Life support devices or systems are intended to be implanted in the human body or to support and/or maintain and sustain and/or protect human life. If they fail, it is reasonable to assume that the health of the user or other persons may be endangered.

单击下面可查看定价，库存，交付和生命周期等信息

[>>Infineon Technologies\(英飞凌\)](#)

[>>点击查看相关商品](#)