

# IRG4PH20KDPbF

INSULATED GATE BIPOLAR TRANSISTOR WITH  
ULTRAFAST SOFT RECOVERY DIODE

Short Circuit Rated  
UltraFast IGBT

### Features

- High short circuit rating optimized for motor control,  $t_{sc} = 10\mu s$ ,  $V_{CC} = 720V$ ,  $T_J = 125^\circ C$ ,  $V_{GE} = 15V$
- Combines low conduction losses with high switching speed
- Tighter parameter distribution and higher efficiency than previous generations
- IGBT co-packaged with HEXFRED™ ultrafast, ultrasoft recovery antiparallel diodes

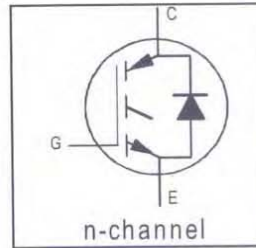

$V_{CES} = 1200V$
$V_{CE(on) typ.} = 3.17V$
@ $V_{GE} = 15V, I_C = 5.0A$

### Benefits

- Latest generation 4 IGBT's offer highest power density motor controls possible
- HEXFRED™ diodes optimized for performance with IGBTs. Minimized recovery characteristics reduce noise, EMI and switching losses
- Lead-Free

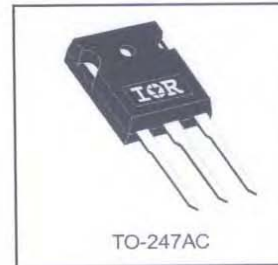

### Absolute Maximum Ratings

	Parameter	Max.	Units
$V_{CES}$	Collector-to-Emitter Voltage	1200	V
$I_C @ T_C = 25^\circ C$	Continuous Collector Current	11	A
$I_C @ T_C = 100^\circ C$	Continuous Collector Current	5.0	
$I_{CM}$	Pulsed Collector Current ①	22	
$I_{LM}$	Clamped Inductive Load Current ②	22	
$I_F @ T_C = 100^\circ C$	Diode Continuous Forward Current	5.0	
$I_{FM}$	Diode Maximum Forward Current	22	
$t_{sc}$	Short Circuit Withstand Time	10	$\mu s$
$V_{GE}$	Gate-to-Emitter Voltage	$\pm 20$	V
$P_D @ T_C = 25^\circ C$	Maximum Power Dissipation	60	W
$P_D @ T_C = 100^\circ C$	Maximum Power Dissipation	24	
$T_J$	Operating Junction and	-55 to +150	$^\circ C$
$T_{STG}$	Storage Temperature Range		
	Soldering Temperature, for 10 sec.	300 (0.063 in. (1.6mm) from case)	
	Mounting Torque, 6-32 or M3 Screw.	10 lbf·in (1.1 N·m)	

### Thermal Resistance

	Parameter	Min.	Typ.	Max.	Units
$R_{\theta JC}$	Junction-to-Case - IGBT	—	—	2.1	$^\circ C/W$
$R_{\theta JC}$	Junction-to-Case - Diode	—	—	3.5	
$R_{\theta CS}$	Case-to-Sink, flat, greased surface	—	0.24	—	
$R_{\theta JA}$	Junction-to-Ambient, typical socket mount	—	—	40	
Wt	Weight	—	6 (0.21)	—	g (oz)

# IRG4PH20KDPbF

International  
IR Rectifier

## Electrical Characteristics @ T<sub>J</sub> = 25°C (unless otherwise specified)

	Parameter	Min.	Typ.	Max.	Units	Conditions
V <sub>(BR)CES</sub>	Collector-to-Emitter Breakdown Voltage <sup>③</sup>	1200	—	—	V	V <sub>GE</sub> = 0V, I <sub>C</sub> = 250μA
ΔV <sub>(BR)CES/ΔT<sub>J</sub></sub>	Temperature Coeff. of Breakdown Voltage	—	1.13	—	V/°C	V <sub>GE</sub> = 0V, I <sub>C</sub> = 2.5mA
V <sub>CE(on)</sub>	Collector-to-Emitter Saturation Voltage	—	3.17	4.3	V	I <sub>C</sub> = 5.0A V <sub>GE</sub> = 15V
		—	4.04	—		I <sub>C</sub> = 11A See Fig. 2, 5
		—	2.84	—		I <sub>C</sub> = 5.0A, T <sub>J</sub> = 150°C
V <sub>GE(th)</sub>	Gate Threshold Voltage	3.5	—	6.5		V <sub>CE</sub> = V <sub>GE</sub> , I <sub>C</sub> = 250μA
ΔV <sub>GE(th)/ΔT<sub>J</sub></sub>	Temperature Coeff. of Threshold Voltage	—	-10	—	mV/°C	V <sub>CE</sub> = V <sub>GE</sub> , I <sub>C</sub> = 1mA
g <sub>fe</sub>	Forward Transconductance <sup>④</sup>	2.3	3.5	—	S	V <sub>CE</sub> = 100V, I <sub>C</sub> = 5.0A
I <sub>CES</sub>	Zero Gate Voltage Collector Current	—	—	250	μA	V <sub>GE</sub> = 0V, V <sub>CE</sub> = 1200V
		—	—	1000		V <sub>GE</sub> = 0V, V <sub>CE</sub> = 1200V, T <sub>J</sub> = 150°C
V <sub>FM</sub>	Diode Forward Voltage Drop	—	2.5	2.9	V	I <sub>C</sub> = 5.0A See Fig. 13
		—	2.2	2.6		I <sub>C</sub> = 5.0A, T <sub>J</sub> = 150°C
I <sub>GES</sub>	Gate-to-Emitter Leakage Current	—	—	±100	nA	V <sub>GE</sub> = ±20V

## Switching Characteristics @ T<sub>J</sub> = 25°C (unless otherwise specified)

	Parameter	Min.	Typ.	Max.	Units	Conditions
Q <sub>g</sub>	Total Gate Charge (turn-on)	—	28	43	nC	I <sub>C</sub> = 5.0A
Q <sub>ge</sub>	Gate - Emitter Charge (turn-on)	—	4.4	6.6		V <sub>CC</sub> = 400V See Fig.8
Q <sub>gc</sub>	Gate - Collector Charge (turn-on)	—	12	18		V <sub>GE</sub> = 15V
t <sub>d(on)</sub>	Turn-On Delay Time	—	50	—	ns	T <sub>J</sub> = 25°C
t <sub>r</sub>	Rise Time	—	30	—		I <sub>C</sub> = 5.0A, V <sub>CC</sub> = 800V
t <sub>d(off)</sub>	Turn-Off Delay Time	—	100	150		V <sub>GE</sub> = 15V, R <sub>G</sub> = 50Ω
t <sub>f</sub>	Fall Time	—	250	380		Energy losses include "tail" and diode reverse recovery
E <sub>on</sub>	Turn-On Switching Loss	—	0.62	—	mJ	See Fig. 9,10,18
E <sub>off</sub>	Turn-Off Switching Loss	—	0.30	—		
E <sub>ts</sub>	Total Switching Loss	—	0.92	1.2	μs	V <sub>CC</sub> = 720V, T <sub>J</sub> = 125°C
t <sub>sc</sub>	Short Circuit Withstand Time	10	—	—		V <sub>GE</sub> = 15V, R <sub>G</sub> = 50Ω
t <sub>d(on)</sub>	Turn-On Delay Time	—	50	—	ns	T <sub>J</sub> = 150°C, See Fig. 10,11,18
t <sub>r</sub>	Rise Time	—	30	—		I <sub>C</sub> = 5.0A, V <sub>CC</sub> = 800V
t <sub>d(off)</sub>	Turn-Off Delay Time	—	110	—		V <sub>GE</sub> = 15V, R <sub>G</sub> = 50Ω,
t <sub>f</sub>	Fall Time	—	620	—		Energy losses include "tail" and diode reverse recovery
E <sub>ts</sub>	Total Switching Loss	—	1.6	—	mJ	Measured 5mm from package
L <sub>E</sub>	Internal Emitter Inductance	—	13	—		nH
C <sub>ies</sub>	Input Capacitance	—	435	—	pF	V <sub>GE</sub> = 0V
C <sub>oes</sub>	Output Capacitance	—	44	—		V <sub>CC</sub> = 30V See Fig. 7
C <sub>res</sub>	Reverse Transfer Capacitance	—	8.3	—		f = 1.0MHz
t <sub>rr</sub>	Diode Reverse Recovery Time	—	51	77	ns	T <sub>J</sub> = 25°C See Fig. 14
		—	68	102		T <sub>J</sub> = 125°C
I <sub>rr</sub>	Diode Peak Reverse Recovery Current	—	6.0	9.0	A	T <sub>J</sub> = 25°C See Fig. 15
		—	7.0	11		T <sub>J</sub> = 125°C
Q <sub>rr</sub>	Diode Reverse Recovery Charge	—	183	274	nC	T <sub>J</sub> = 25°C See Fig. 16
		—	285	427		T <sub>J</sub> = 125°C
di <sub>(rec)</sub> /dt	Diode Peak Rate of Fall of Recovery During t <sub>r</sub>	—	380	—	A/μs	T <sub>J</sub> = 25°C See Fig. 17
		—	307	—		T <sub>J</sub> = 125°C

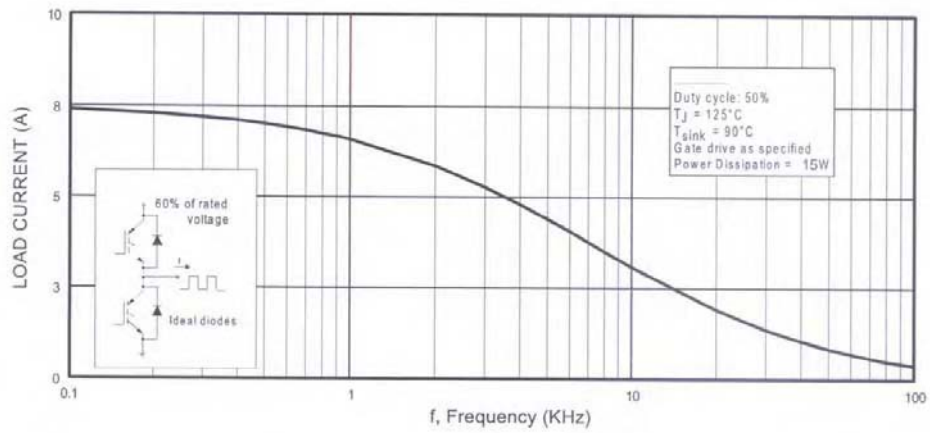

**Fig. 1 - Typical Load Current vs. Frequency**  
 (Load Current =  $I_{RMS}$  of fundamental)

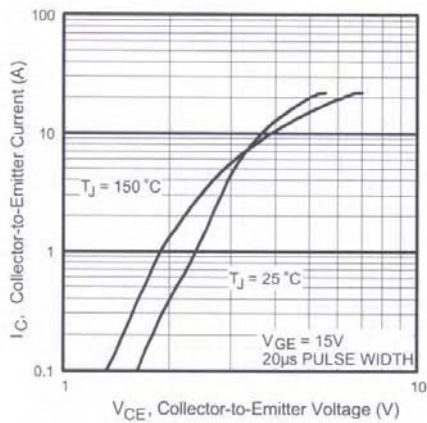

**Fig. 2 - Typical Output Characteristics**

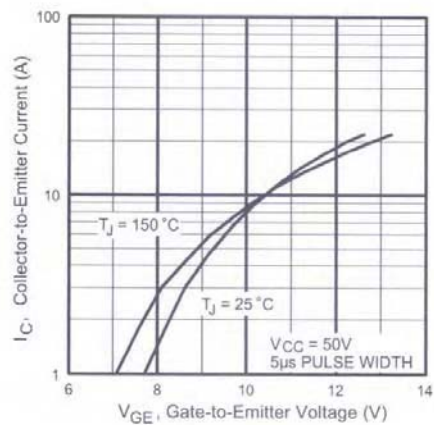

**Fig. 3 - Typical Transfer Characteristics**

# IRG4PH20KDPbF

International  
**IRF** Rectifier

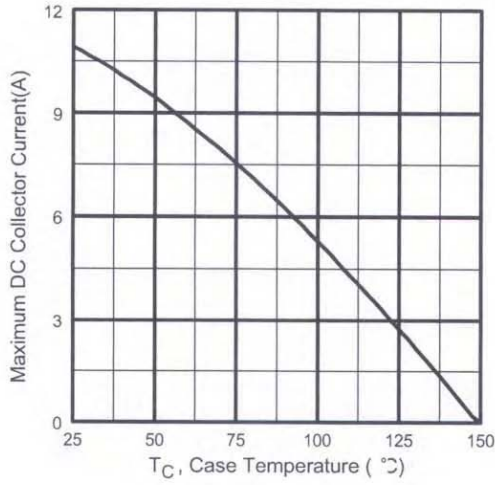

Fig. 4 - Maximum Collector Current vs. Case Temperature

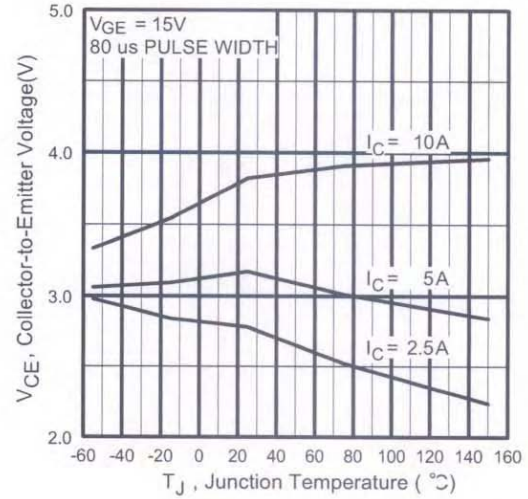

Fig. 5 - Typical Collector-to-Emitter Voltage vs. Junction Temperature

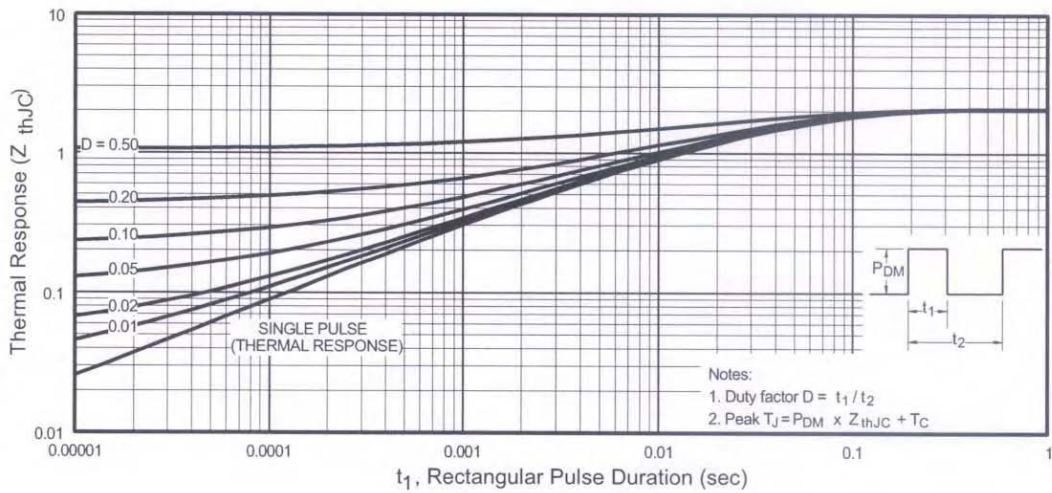

Fig. 6 - Maximum Effective Transient Thermal Impedance, Junction-to-Case

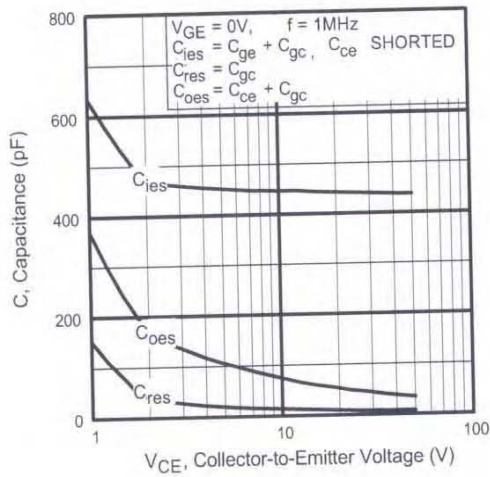

Fig. 7 - Typical Capacitance vs. Collector-to-Emitter Voltage

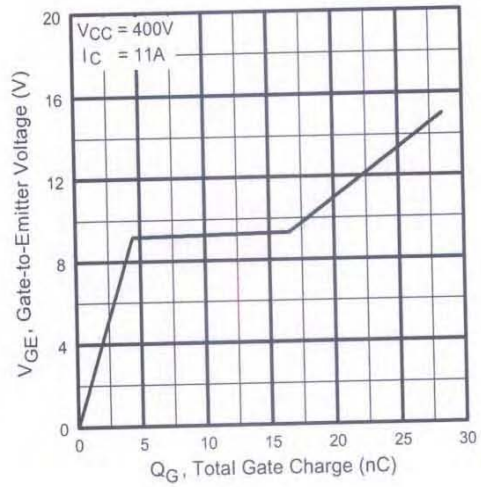

Fig. 8 - Typical Gate Charge vs. Gate-to-Emitter Voltage

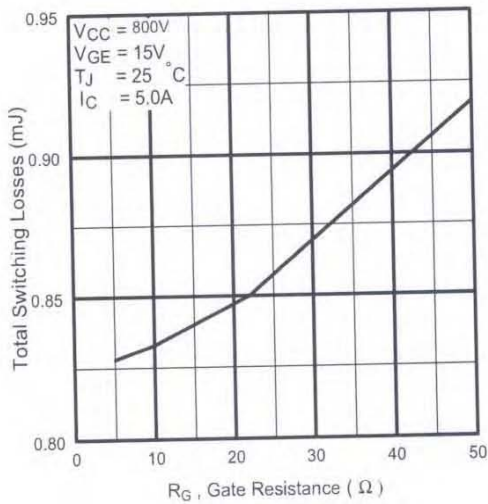

Fig. 9 - Typical Switching Losses vs. Gate Resistance

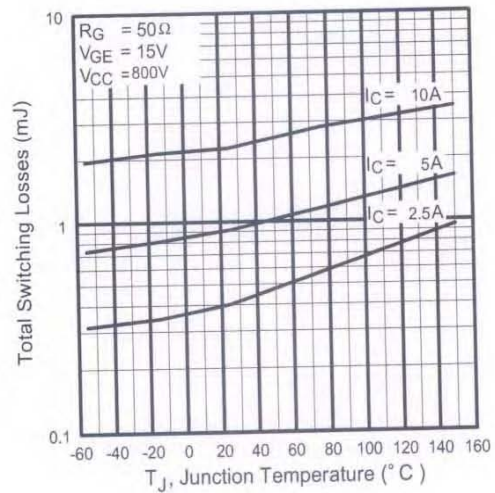

Fig. 10 - Typical Switching Losses vs. Junction Temperature

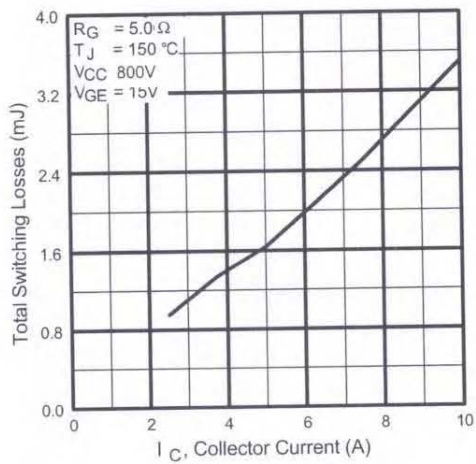

Fig. 11 - Typical Switching Losses vs. Collector Current

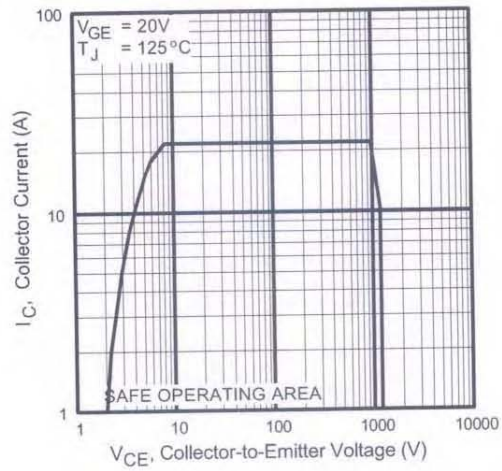

Fig. 12 - Turn-Off SOA

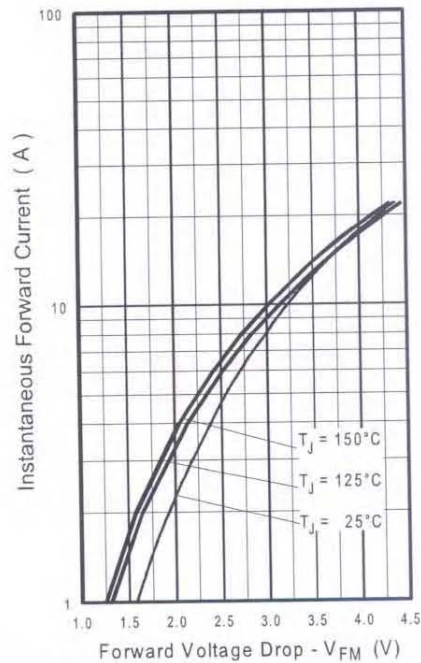

Fig. 13 - Typical Forward Voltage Drop vs. Instantaneous Forward Current

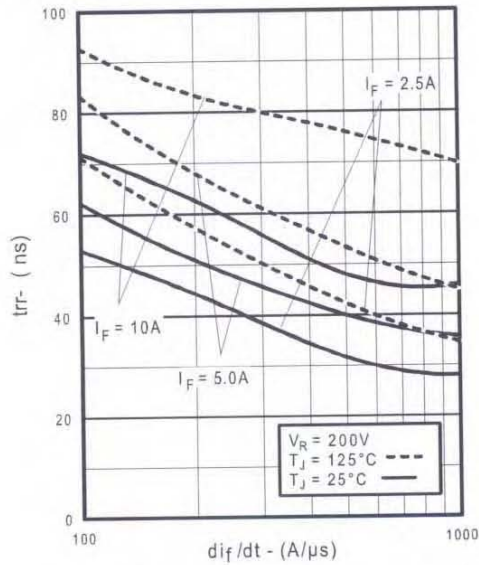

Fig. 14 - Typical Reverse Recovery vs.  $di_f/dt$

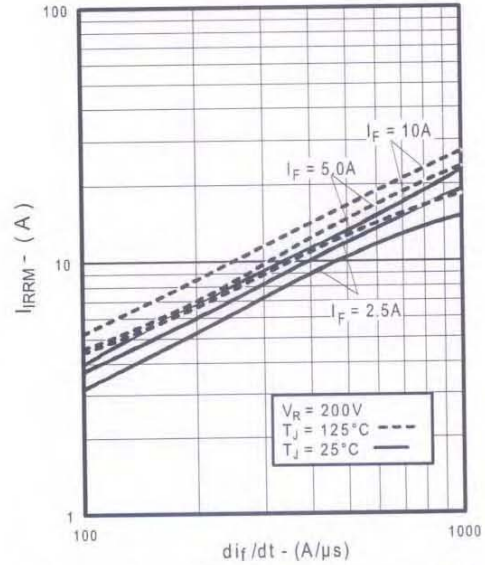

Fig. 15 - Typical Recovery Current vs.  $di_f/dt$

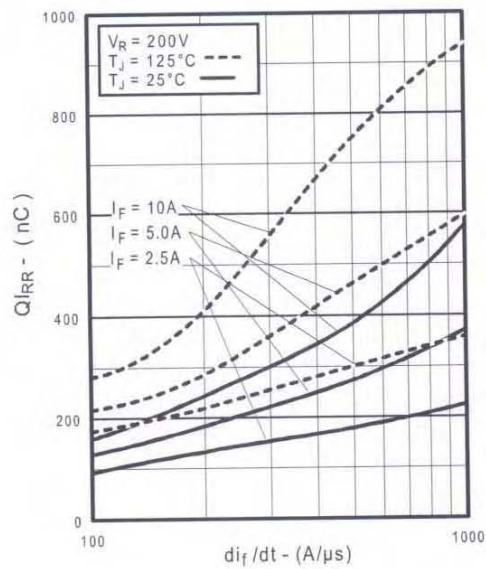

Fig. 16 - Typical Stored Charge vs.  $di_f/dt$

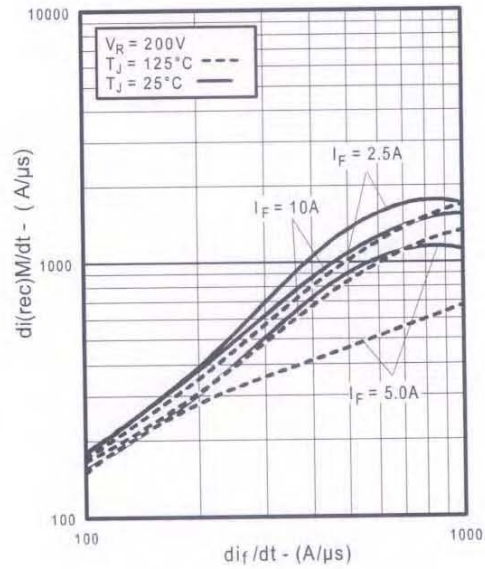
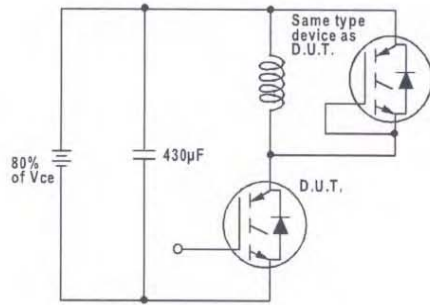

Fig. 17 - Typical  $di_{(rec)M}/dt$  vs.  $di_f/dt$

# IRG4PH20KDPbF

International  
**IRF** Rectifier



**Fig. 18a** - Test Circuit for Measurement of  $I_{LM}$ ,  $E_{on}$ ,  $E_{off}(\text{diode})$ ,  $t_{rr}$ ,  $Q_{rr}$ ,  $I_{rr}$ ,  $t_{d(on)}$ ,  $t_r$ ,  $t_{d(off)}$ ,  $t_f$

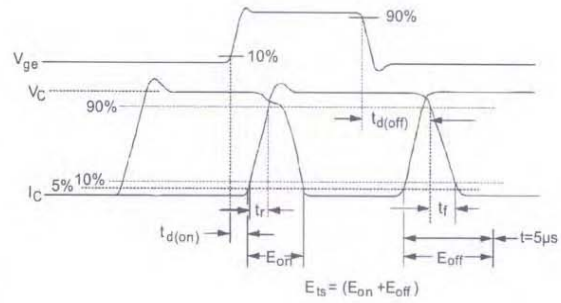

**Fig. 18b** - Test Waveforms for Circuit of Fig. 18a, Defining  $E_{off}$ ,  $t_{d(off)}$ ,  $t_f$

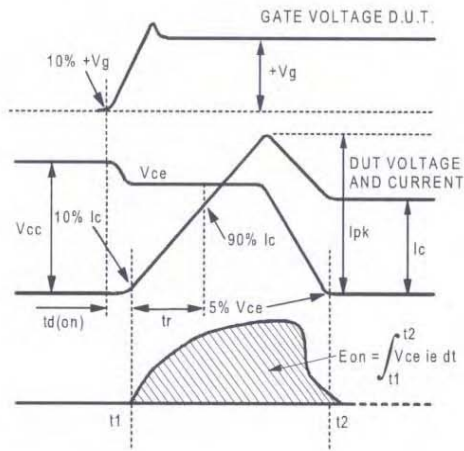

**Fig. 18c** - Test Waveforms for Circuit of Fig. 18a, Defining  $E_{on}$ ,  $t_{d(on)}$ ,  $t_r$

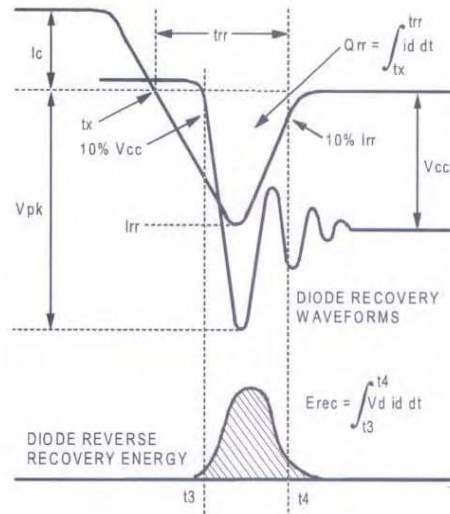

**Fig. 18d** - Test Waveforms for Circuit of Fig. 18a, Defining  $E_{rec}$ ,  $t_{rr}$ ,  $Q_{rr}$ ,  $I_{rr}$



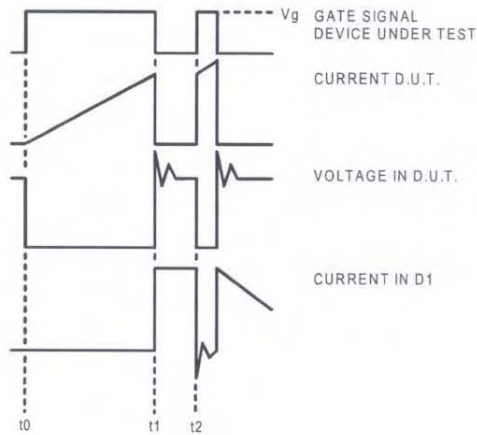

Figure 18e. Macro Waveforms for Figure 18a's Test Circuit

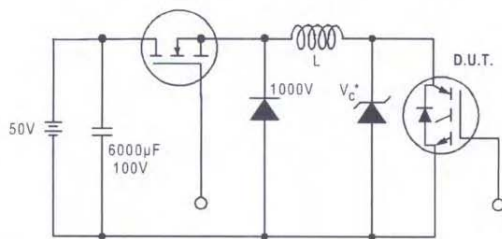

Figure 19. Clamped Inductive Load Test Circuit

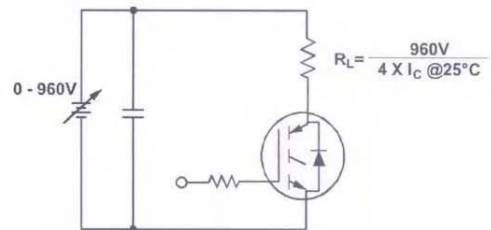

Figure 20. Pulsed Collector Current Test Circuit

# IRG4PH20KDPbF

International  
**IR** Rectifier

## Notes:

- ① Repetitive rating:  $V_{GE}=20V$ ; pulse width limited by maximum junction temperature (figure 20)
- ②  $V_{CC}=80\%(V_{CES})$ ,  $V_{GE}=20V$ ,  $L=10\mu H$ ,  $R_G=5.0\Omega$  (figure 19)
- ③ Pulse width  $\leq 80\mu s$ ; duty factor  $\leq 0.1\%$ .
- ④ Pulse width  $5.0\mu s$ , single shot.

## TO-247AC Package Outline

Dimensions are shown in millimeters (inches)

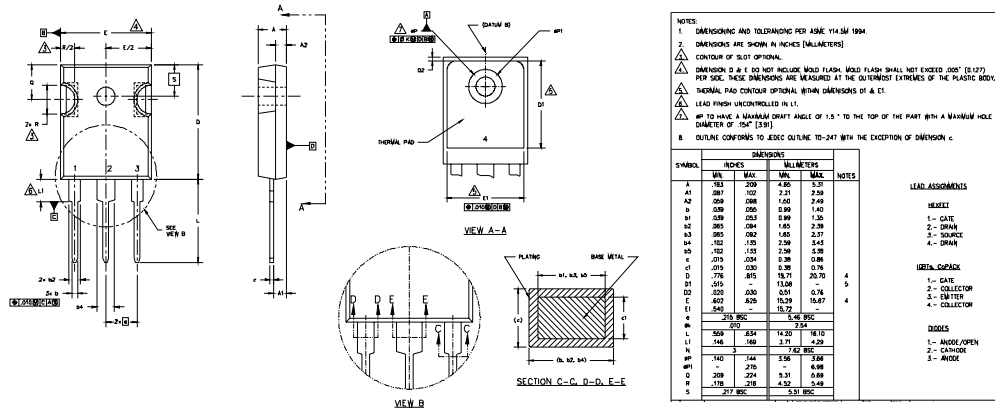

## TO-247AC Part Marking Information

EXAMPLE: THIS IS AN IRFPE30  
WITH ASSEMBLY  
LOT CODE 5657  
ASSEMBLED ON WW 35, 2000  
IN THE ASSEMBLY LINE "H"  
**Note:** "P" in assembly line  
position indicates "Lead-Free"

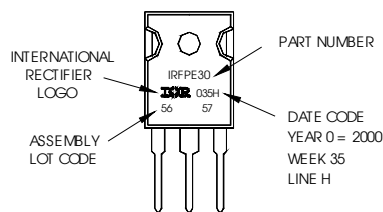

Data and specifications subject to change without notice.

International  
**IR** Rectifier

IR WORLD HEADQUARTERS: 233 Kansas St., El Segundo, California 90245, USA Tel: (310) 252-7105  
TAC Fax: (310) 252-7903

Visit us at [www.irf.com](http://www.irf.com) for sales contact information.06/04

[www.irf.com](http://www.irf.com)

Note: For the most current drawings please refer to the IR website at:  
<http://www.irf.com/package/>

单击下面可查看定价，库存，交付和生命周期等信息

[>>Infineon Technologies\(英飞凌\)](#)