

IRF7815PbF

HEXFET® Power MOSFET

Applications

- Synchronous MOSFET for Notebook Processor Power
- Synchronous Rectifier MOSFET for Isolated DC-DC Converters in Networking Systems

Benefits

- Very Low $R_{DS(on)}$ at 10V V_{GS}
- Low Gate Charge
- Fully Characterized Avalanche Voltage and Current
- 20V V_{GS} Max. Gate Rating

V_{DSS}	$R_{DS(on)}$ max	Q_g (typ.)
150V	43m Ω @ $V_{GS} = 10V$	25nC

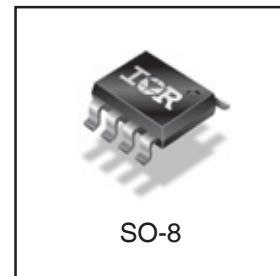
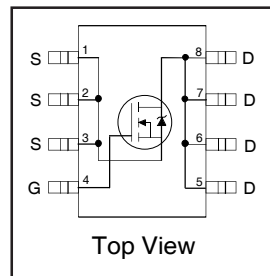

Absolute Maximum Ratings

	Parameter	Max.	Units
V_{DS}	Drain-to-Source Voltage	150	V
V_{GS}	Gate-to-Source Voltage	± 20	
I_D @ $T_A = 25^\circ C$	Continuous Drain Current, V_{GS} @ 10V	5.1	A
I_D @ $T_A = 70^\circ C$	Continuous Drain Current, V_{GS} @ 10V	4.1	
I_{DM}	Pulsed Drain Current ①	41	
P_D @ $T_A = 25^\circ C$	Power Dissipation ④	2.5	W
P_D @ $T_A = 70^\circ C$	Power Dissipation ④	1.6	
	Linear Derating Factor	0.02	W/ $^\circ C$
T_J T_{STG}	Operating Junction and Storage Temperature Range	-55 to +150	$^\circ C$

Thermal Resistance

	Parameter	Typ.	Max.	Units
$R_{\theta JL}$	Junction-to-Drain Lead ⑤	—	20	$^\circ C/W$
$R_{\theta JA}$	Junction-to-Ambient ⑥	—	50	

Notes ① through ⑥ are on page 9

www.irf.com

1

12/01/09

Static @ T_J = 25°C (unless otherwise specified)

	Parameter	Min.	Typ.	Max.	Units	Conditions
B _V DSS	Drain-to-Source Breakdown Voltage	150	—	—	V	V _{GS} = 0V, I _D = 250μA
ΔB _V DSS/ΔT _J	Breakdown Voltage Temp. Coefficient	—	0.17	—	V/°C	Reference to 25°C, I _D = 1mA
R _{DS(on)}	Static Drain-to-Source On-Resistance	—	34	43	mΩ	V _{GS} = 10V, I _D = 3.1A ③
V _{GS(th)}	Gate Threshold Voltage	3.0	4.0	5.0	V	V _{DS} = V _{GS} , I _D = 100μA
ΔV _{GS(th)}	Gate Threshold Voltage Coefficient	—	-12.2	—	mV/°C	
I _{DSS}	Drain-to-Source Leakage Current	—	—	20	μA	V _{DS} = 150V, V _{GS} = 0V
		—	—	250		V _{DS} = 150V, V _{GS} = 0V, T _J = 125°C
I _{GSS}	Gate-to-Source Forward Leakage	—	—	100	nA	V _{GS} = 20V
	Gate-to-Source Reverse Leakage	—	—	-100		V _{GS} = -20V
g _{fs}	Forward Transconductance	8.2	—	—	S	V _{DS} = 50V, I _D = 3.1A
Q _g	Total Gate Charge	—	25	38	nC	V _{DS} = 75V V _{GS} = 10V I _D = 3.1A See Figs. 6, 16a & 16b
Q _{gs1}	Pre-V _{th} Gate-to-Source Charge	—	6.5	—		
Q _{gs2}	Post-V _{th} Gate-to-Source Charge	—	1.3	—		
Q _{gs}	Gate-to-Source Charge	—	7.8	—		
Q _{gd}	Gate-to-Drain Charge	—	7.4	—		
Q _{godr}	Gate Charge Overdrive	—	9.8	—		
Q _{sw}	Switch Charge (Q _{gs2} + Q _{gd})	—	8.7	—		
Q _{oss}	Output Charge	—	10	—	nC	V _{DS} = 16V, V _{GS} = 0V
R _G	Gate Resistance	—	1.02	—	Ω	
t _{d(on)}	Turn-On Delay Time	—	8.4	—	ns	V _{DD} = 75V, V _{GS} = 10V ③ I _D = 3.1A R _G = 1.8Ω See Figs. 15a & 15b
t _r	Rise Time	—	3.2	—		
t _{d(off)}	Turn-Off Delay Time	—	14	—		
t _f	Fall Time	—	8.3	—		
C _{iss}	Input Capacitance	—	1647	—	pF	V _{GS} = 0V V _{DS} = 75V f = 1.0MHz
C _{oss}	Output Capacitance	—	129	—		
C _{rss}	Reverse Transfer Capacitance	—	30	—		

Avalanche Characteristics

	Parameter	Typ.	Max.	Units
E _{AS}	Single Pulse Avalanche Energy ②	—	529	mJ
I _{AR}	Avalanche Current ①	—	3.1	A

Diode Characteristics

	Parameter	Min.	Typ.	Max.	Units	Conditions
I _S	Continuous Source Current (Body Diode)	—	—	2.3	A	MOSFET symbol showing the integral reverse p-n junction diode.
I _{SM}	Pulsed Source Current (Body Diode) ①	—	—	41		
V _{SD}	Diode Forward Voltage	—	—	1.3	V	T _J = 25°C, I _S = 3.1A, V _{GS} = 0V ③
t _{rr}	Reverse Recovery Time	—	41	62	ns	T _J = 25°C, I _F = 3.1A, V _{DD} = 75V
Q _{rr}	Reverse Recovery Charge	—	213	320	nC	di/dt = 300A/μs ③

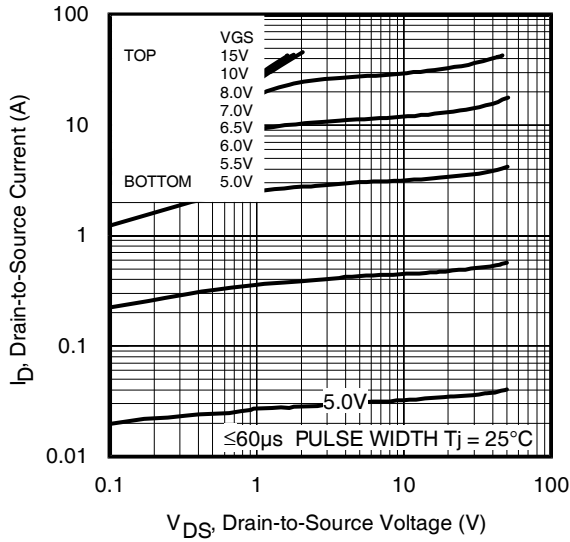

Fig 1. Typical Output Characteristics

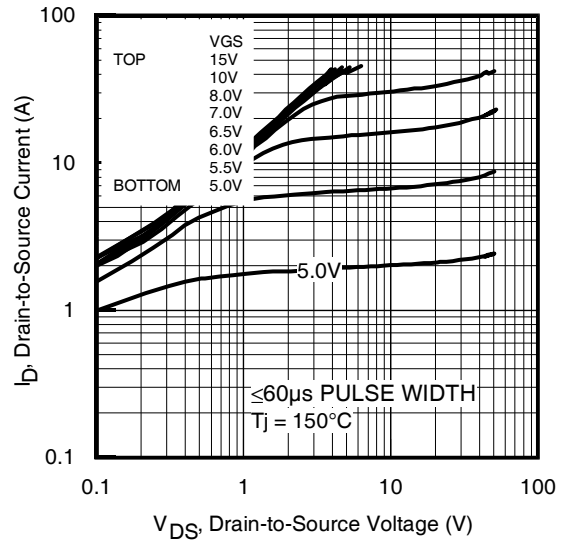

Fig 2. Typical Output Characteristics

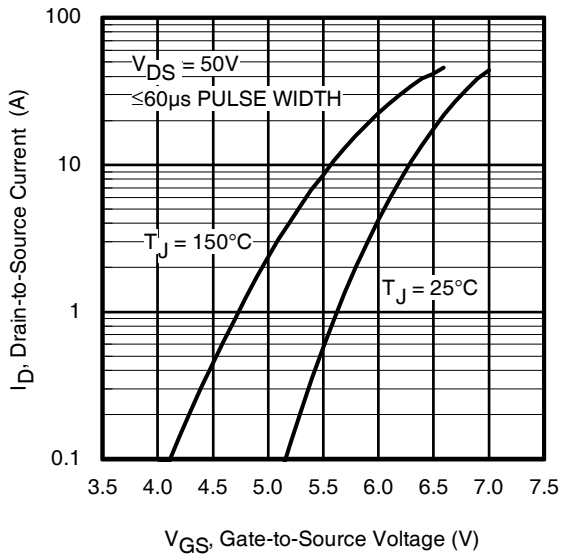

Fig 3. Typical Transfer Characteristics

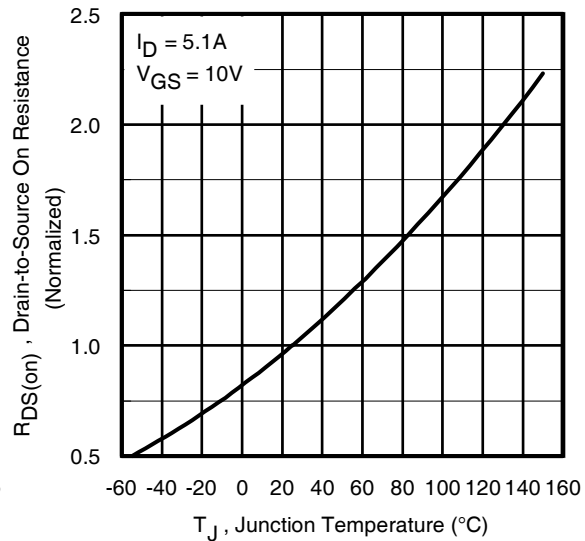

Fig 4. Normalized On-Resistance Vs. Temperature

IRF7815PbF

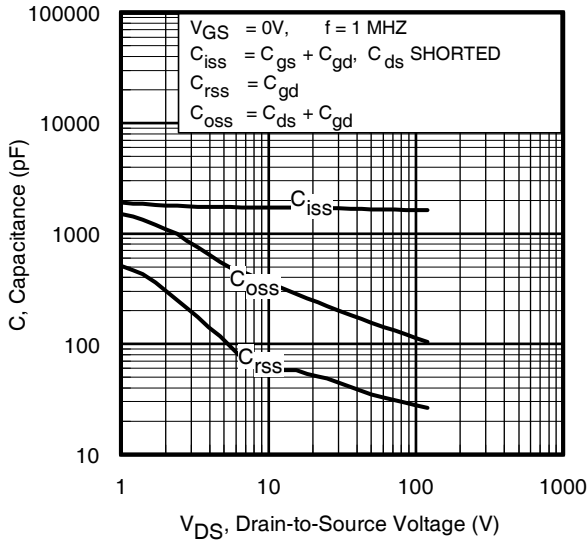

Fig 5. Typical Capacitance Vs. Drain-to-Source Voltage

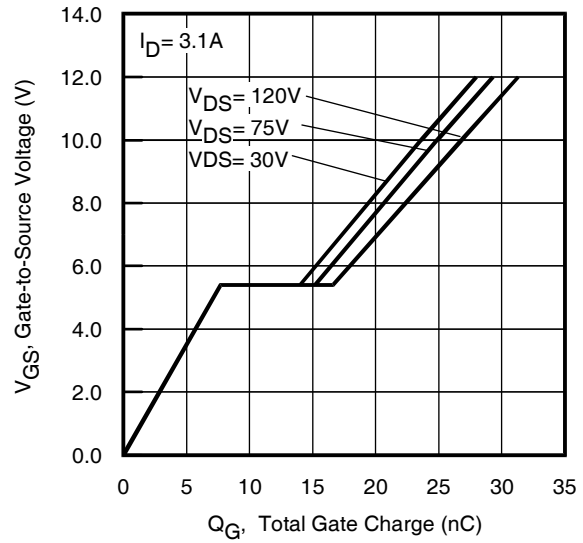

Fig 6. Typical Gate Charge Vs. Gate-to-Source Voltage

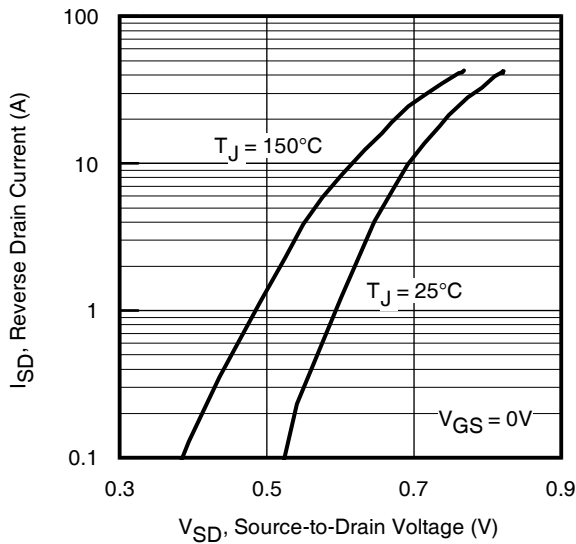

Fig 7. Typical Source-Drain Diode Forward Voltage

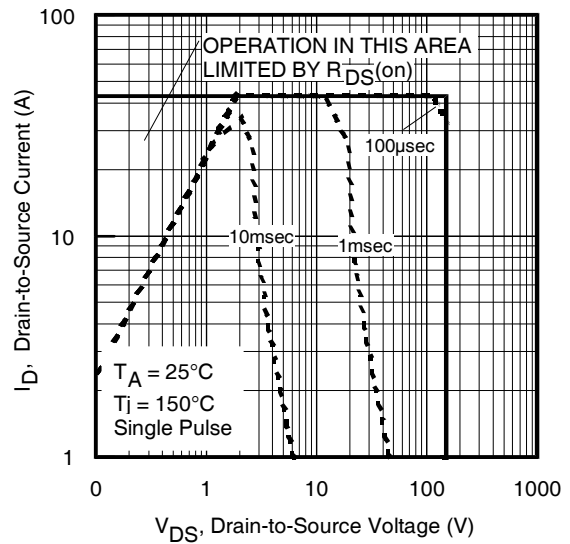

Fig 8. Maximum Safe Operating Area

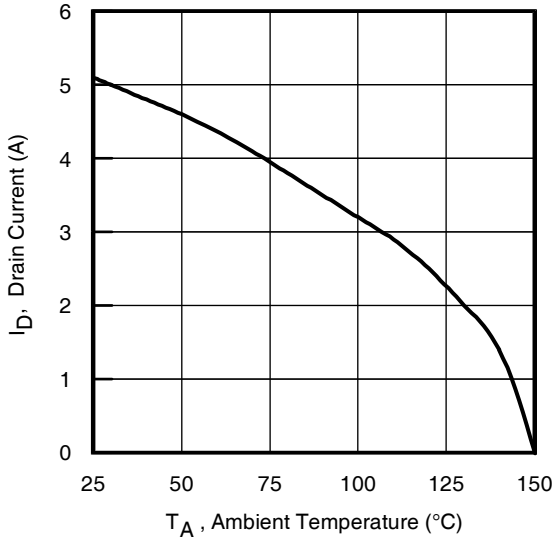

Fig 9. Maximum Drain Current Vs. Ambient Temperature

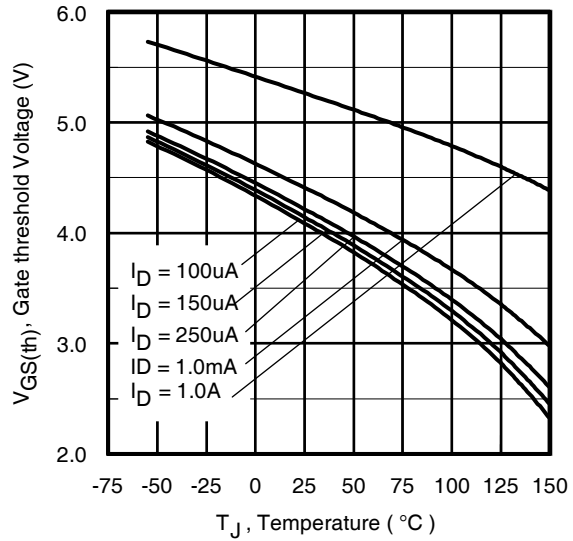

Fig 10. Threshold Voltage Vs. Temperature

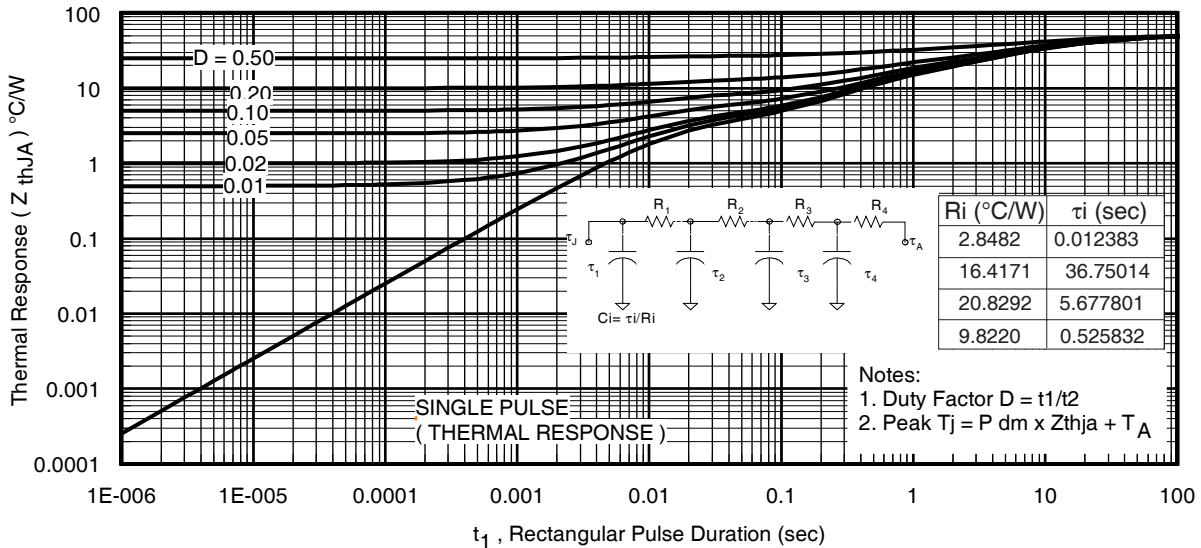

Fig 11. Maximum Effective Transient Thermal Impedance, Junction-to-Ambient

IRF7815PbF

International
IR Rectifier

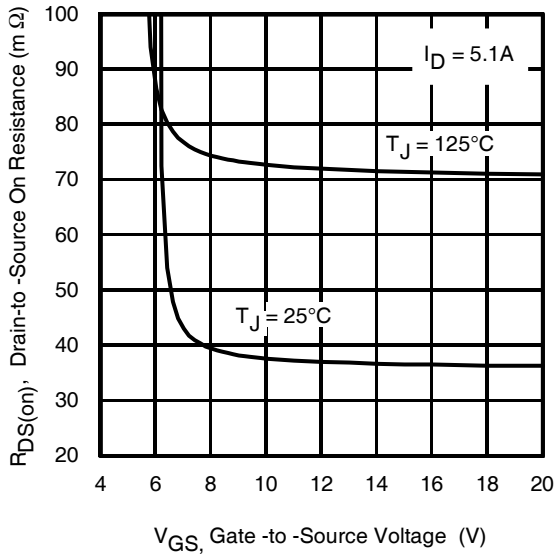

Fig 12. On-Resistance Vs. Gate Voltage

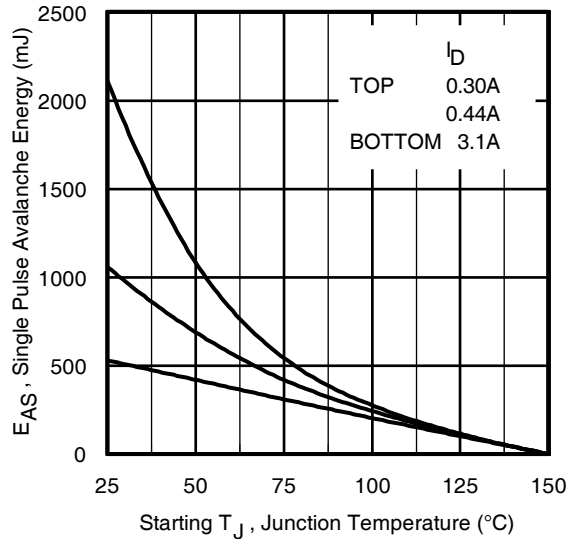

Fig 13c. Maximum Avalanche Energy Vs. Drain Current

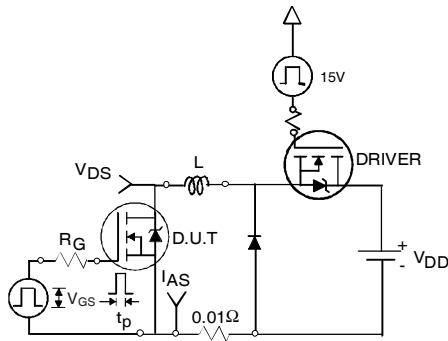

Fig 14a. Unclamped Inductive Test Circuit

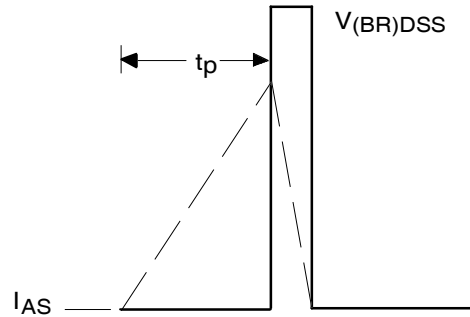

Fig 14b. Unclamped Inductive Waveforms

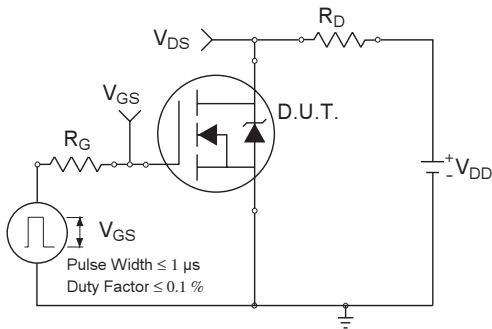

Fig 15a. Switching Time Test Circuit

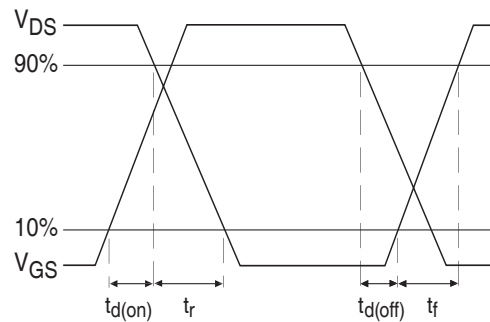

Fig 15b. Switching Time Waveforms

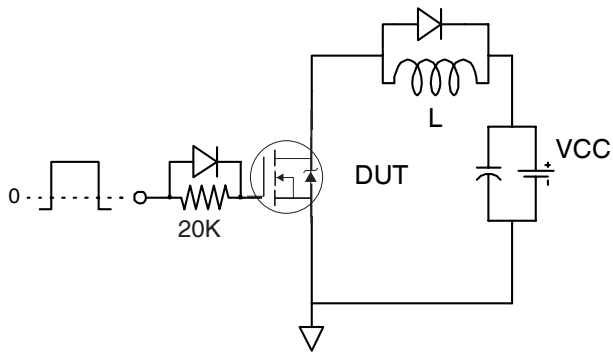

Fig 16a. Gate Charge Test Circuit

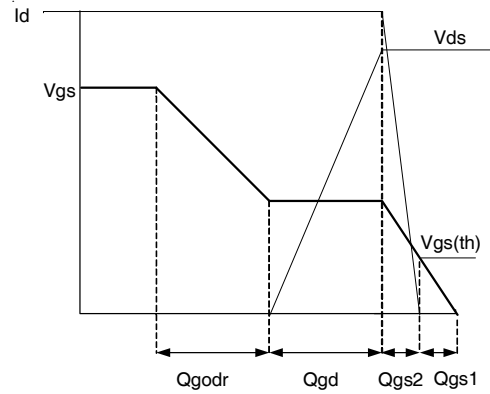

Fig 16b. Gate Charge Waveform

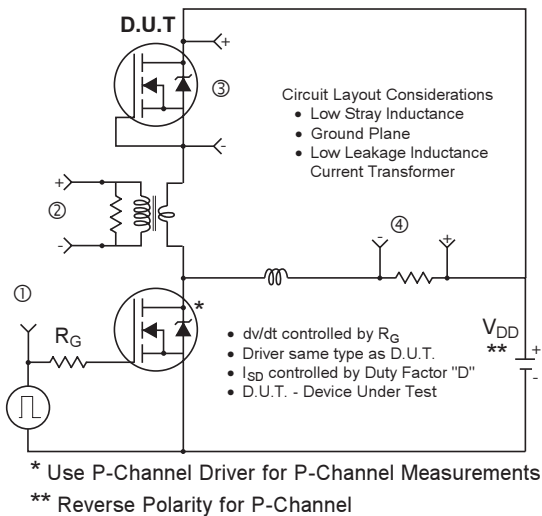
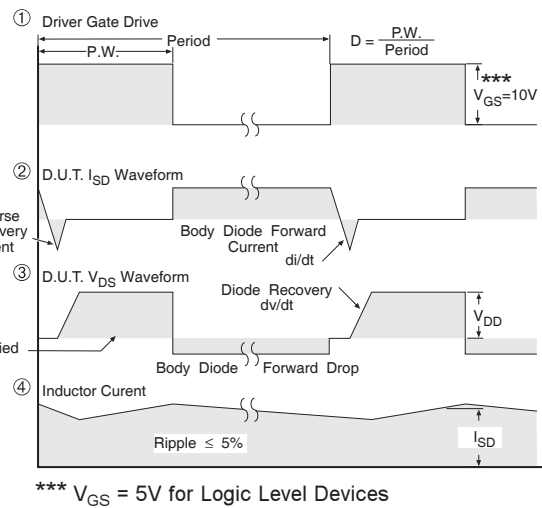

Fig 17. Diode Reverse Recovery Test Circuit for HEXFET® Power MOSFETs



IRF7815PbF

International
IR Rectifier

SO-8 Package Outline (MOSFET & Fetky)

Dimensions are shown in millimeters (inches)

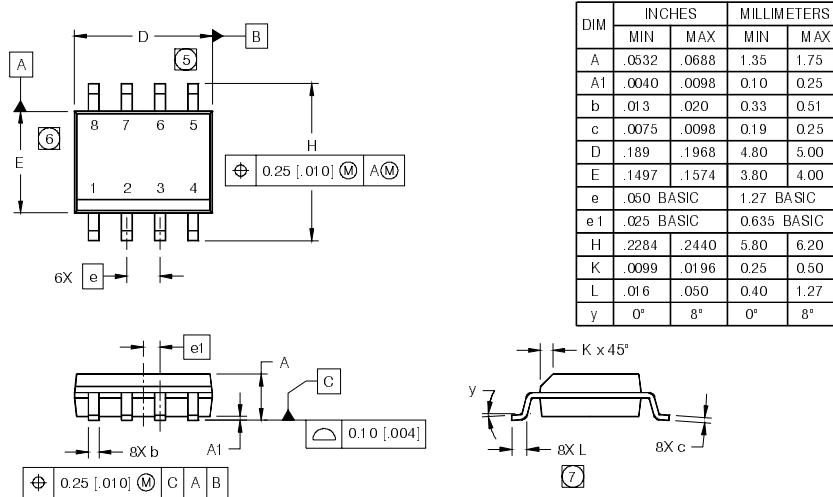

NOTES:

1. DIMENSIONING & TOLERANCING PER ASME Y14.5M-1 994.
2. CONTROLLING DIMENSION: MILLIMETER
3. DIMENSIONS ARE SHOWN IN MILLIMETERS (INCHES).
4. OUTLINE CONFORMS TO JEDEC OUTLINE MS-012AA.
5. DIMENSION DOES NOT INCLUDE MOLD PROTRUSIONS. MOLD PROTRUSIONS NOT TO EXCEED 0.15 [0.006].
6. DIMENSION DOES NOT INCLUDE MOLD PROTRUSIONS. MOLD PROTRUSIONS NOT TO EXCEED 0.25 [0.010].
7. DIMENSION IS THE LENGTH OF LEAD FOR SOLDERING TO A SUBSTRATE.

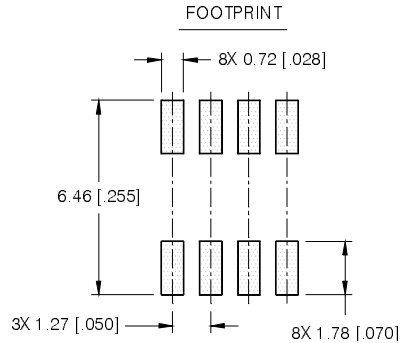

SO-8 Part Marking Information

EXAMPLE: THIS IS AN IRF7101 (MOSFET)

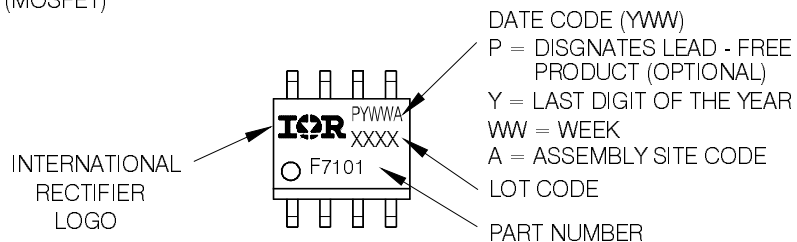

Note: For the most current drawing please refer to IR website at <http://www.irf.com/package/>

SO-8 Tape and Reel

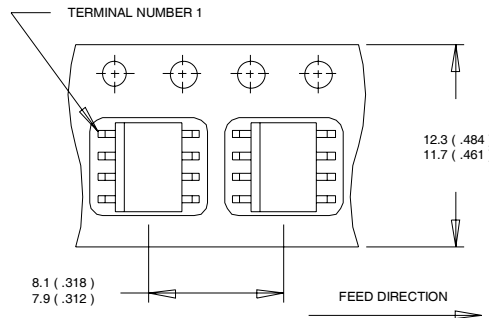

- NOTES:
1. CONTROLLING DIMENSION : MILLIMETER.
 2. ALL DIMENSIONS ARE SHOWN IN MILLIMETERS(INCHES).
 3. OUTLINE CONFORMS TO EIA-481 & EIA-541.

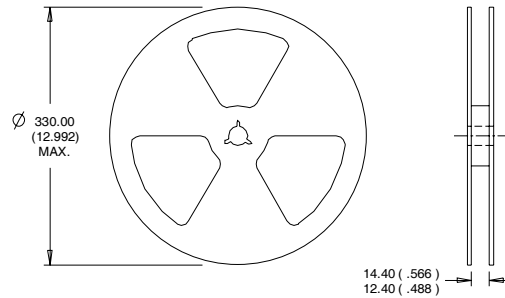

- NOTES :
1. CONTROLLING DIMENSION : MILLIMETER.
 2. OUTLINE CONFORMS TO EIA-481 & EIA-541.

Note: For the most current drawing please refer to IR website at <http://www.irf.com/package/>

Notes:

- ① Repetitive rating; pulse width limited by max. junction temperature.
- ② Starting $T_J = 25^\circ\text{C}$, $L = 110\text{mH}$, $R_G = 25\Omega$, $I_{AS} = 3.1\text{A}$
- ③ Pulse width $\leq 400\mu\text{s}$; duty cycle $\leq 2\%$.
- ④ When mounted on 1 inch square copper board.
- ⑤ R_{θ} is measured at T_J of approximately 90°C .

Data and specifications subject to change without notice.
 This product has been designed and qualified for the Industrial market.
 Qualification Standards can be found on IR's Web site.

单击下面可查看定价，库存，交付和生命周期等信息

[>>Infineon Technologies\(英飞凌\)](#)