

IRG4BC20W

INSULATED GATE BIPOLAR TRANSISTOR

Features

- Designed expressly for Switch-Mode Power Supply and PFC (power factor correction) applications
- Industry-benchmark switching losses improve efficiency of all power supply topologies
- 50% reduction of Eoff parameter
- Low IGBT conduction losses
- Latest-generation IGBT design and construction offers tighter parameters distribution, exceptional reliability
- Lead-Free

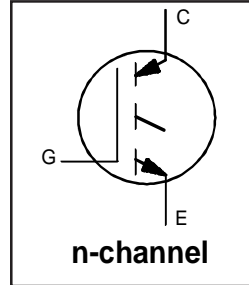

$V_{CES} = 600V$
$V_{CE(on)} \text{ typ.} = 2.16V$
@ $V_{GE} = 15V, I_C = 6.5A$

Benefits

- Lower switching losses allow more cost-effective operation than power MOSFETs up to 150 kHz ("hard switched" mode)
- Of particular benefit to single-ended converters and boost PFC topologies 150W and higher
- Low conduction losses and minimal minority-carrier recombination make these an excellent option for resonant mode switching as well (up to >>300 kHz)

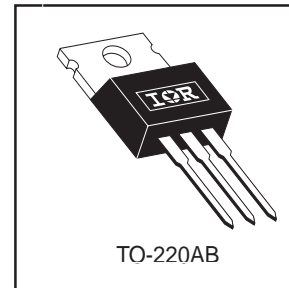

Absolute Maximum Ratings

	Parameter	Max.	Units
V_{CES}	Collector-to-Emitter Breakdown Voltage	600	V
$I_C @ T_C = 25^\circ C$	Continuous Collector Current	13	A
$I_C @ T_C = 100^\circ C$	Continuous Collector Current	6.5	
I_{CM}	Pulsed Collector Current ①	52	
I_{LM}	Clamped Inductive Load Current ②	52	
V_{GE}	Gate-to-Emitter Voltage	± 20	V
E_{ARV}	Reverse Voltage Avalanche Energy ③	200	mJ
$P_D @ T_C = 25^\circ C$	Maximum Power Dissipation	60	W
$P_D @ T_C = 100^\circ C$	Maximum Power Dissipation	24	
T_J	Operating Junction and Storage Temperature Range	-55 to + 150	°C
T_{STG}	Soldering Temperature, for 10 seconds	300 (0.063 in. (1.6mm) from case)	
	Mounting torque, 6-32 or M3 screw.	10 lbf•in (1.1N•m)	

Thermal Resistance

	Parameter	Typ.	Max.	Units
$R_{\theta JC}$	Junction-to-Case	---	2.1	°C/W
$R_{\theta CS}$	Case-to-Sink, Flat, Greased Surface	0.5	---	
$R_{\theta JA}$	Junction-to-Ambient, typical socket mount	---	80	
Wt	Weight	2.0 (0.07)	---	g (oz)

IRG4BC20WPbF

Electrical Characteristics @ $T_J = 25^\circ\text{C}$ (unless otherwise specified)

	Parameter	Min.	Typ.	Max.	Units	Conditions
$V_{(BR)CES}$	Collector-to-Emitter Breakdown Voltage	600	—	—	V	$V_{GE} = 0V, I_C = 250\mu A$
$V_{(BR)ECS}$	Emitter-to-Collector Breakdown Voltage ④	18	—	—	V	$V_{GE} = 0V, I_C = 1.0A$
$\Delta V_{(BR)CES}/\Delta T_J$	Temperature Coeff. of Breakdown Voltage	—	0.48	—	V/°C	$V_{GE} = 0V, I_C = 1.0mA$
$V_{CE(ON)}$	Collector-to-Emitter Saturation Voltage	—	2.16	2.6	V	$I_C = 6.5A, V_{GE} = 15V$
		—	2.55	—		$I_C = 13A$
		—	2.05	—		$I_C = 6.5A, T_J = 150^\circ\text{C}$
$V_{GE(th)}$	Gate Threshold Voltage	3.0	—	6.0		$V_{CE} = V_{GE}, I_C = 250\mu A$
$\Delta V_{GE(th)}/\Delta T_J$	Temperature Coeff. of Threshold Voltage	—	-8.8	—	mV/°C	$V_{CE} = V_{GE}, I_C = 250\mu A$
g_{fe}	Forward Transconductance ⑤	5.5	8.3	—	S	$V_{CE} = 100V, I_C = 6.5A$
I_{CES}	Zero Gate Voltage Collector Current	—	—	250	μA	$V_{GE} = 0V, V_{CE} = 600V$
		—	—	2.0		$V_{GE} = 0V, V_{CE} = 10V, T_J = 25^\circ\text{C}$
		—	—	1000		$V_{GE} = 0V, V_{CE} = 600V, T_J = 150^\circ\text{C}$
I_{GES}	Gate-to-Emitter Leakage Current	—	—	± 100	nA	$V_{GE} = \pm 20V$

Switching Characteristics @ $T_J = 25^\circ\text{C}$ (unless otherwise specified)

	Parameter	Min.	Typ.	Max.	Units	Conditions
Q_g	Total Gate Charge (turn-on)	—	26	38	nC	$I_C = 6.5A$
Q_{ge}	Gate - Emitter Charge (turn-on)	—	3.7	5.5		$V_{CC} = 400V$
Q_{gc}	Gate - Collector Charge (turn-on)	—	10	15		$V_{GE} = 15V$
$t_{d(on)}$	Turn-On Delay Time	—	22	—	ns	$T_J = 25^\circ\text{C}$ $I_C = 6.5A, V_{CC} = 480V$ $V_{GE} = 15V, R_G = 50\Omega$
t_r	Rise Time	—	14	—		
$t_{d(off)}$	Turn-Off Delay Time	—	110	160		
t_f	Fall Time	—	64	96		
E_{on}	Turn-On Switching Loss	—	0.06	—		
E_{off}	Turn-Off Switching Loss	—	0.08	—	mJ	Energy losses include "tail" See Fig. 9, 10, 14
E_{ts}	Total Switching Loss	—	0.14	0.2		
$t_{d(on)}$	Turn-On Delay Time	—	21	—	ns	$T_J = 150^\circ\text{C}$, $I_C = 6.5A, V_{CC} = 480V$ $V_{GE} = 15V, R_G = 50\Omega$ Energy losses include "tail"
t_r	Rise Time	—	15	—		
$t_{d(off)}$	Turn-Off Delay Time	—	150	—		
t_f	Fall Time	—	150	—		
E_{ts}	Total Switching Loss	—	0.34	—	mJ	See Fig. 10, 11, 14
L_E	Internal Emitter Inductance	—	7.5	—	nH	Measured 5mm from package
C_{ies}	Input Capacitance	—	490	—	pF	$V_{GE} = 0V$ $V_{CC} = 30V$
C_{oes}	Output Capacitance	—	38	—		
C_{res}	Reverse Transfer Capacitance	—	8.8	—		

Notes:

- ① Repetitive rating; $V_{GE} = 20V$, pulse width limited by max. junction temperature. (See fig. 13b)
- ② $V_{CC} = 80\%(V_{CES}), V_{GE} = 20V, L = 10\mu H, R_G = 50\Omega$, (See fig. 13a)
- ③ Repetitive rating; pulse width limited by maximum junction temperature.
- ④ Pulse width $\leq 80\mu s$; duty factor $\leq 0.1\%$.
- ⑤ Pulse width $5.0\mu s$, single shot.

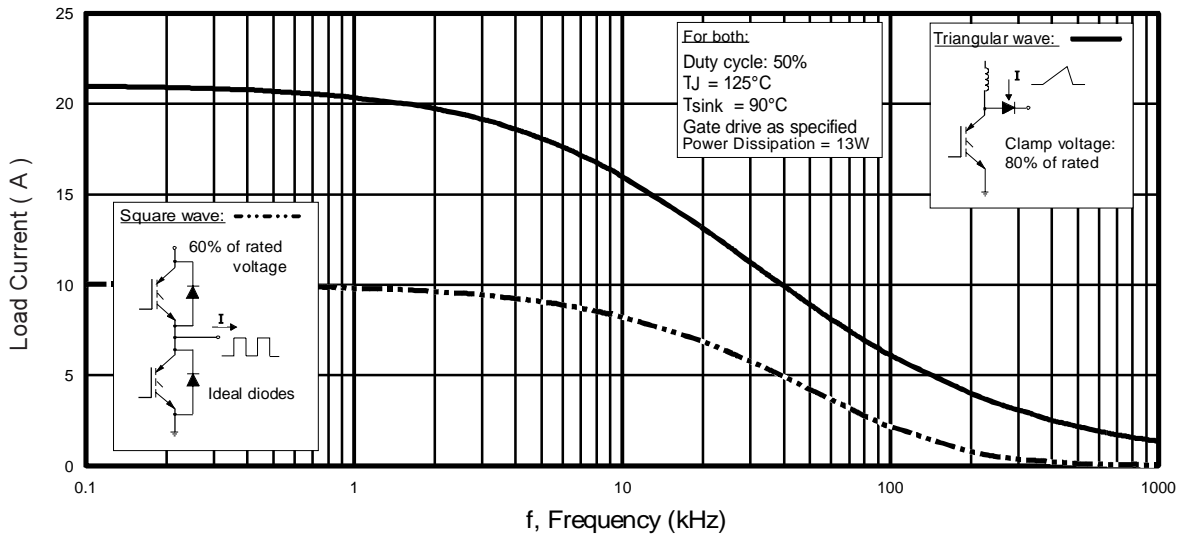

Fig. 1 - Typical Load Current vs. Frequency
(Load Current = I_{RMS} of fundamental)

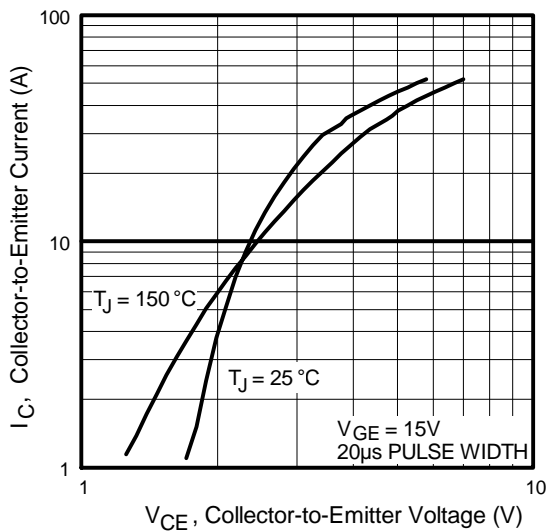

Fig. 2 - Typical Output Characteristics
www.irf.com

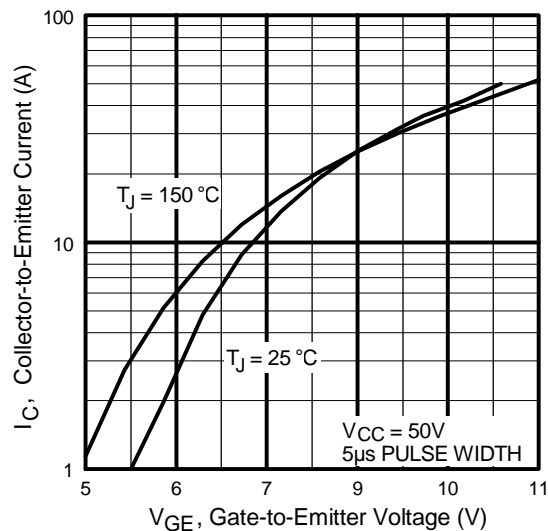

Fig. 3 - Typical Transfer Characteristics

IRG4BC20WPbF

International
IRF Rectifier

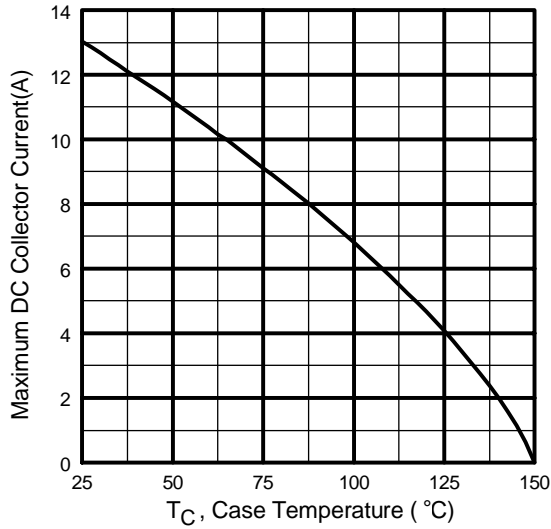

Fig. 4 - Maximum Collector Current vs. Case Temperature

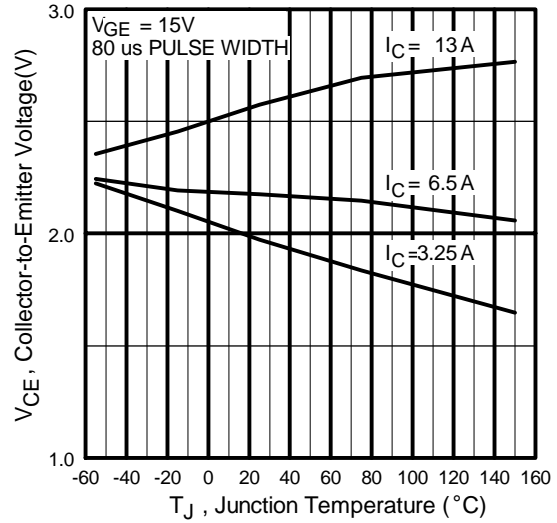

Fig. 5 - Typical Collector-to-Emitter Voltage vs. Junction Temperature

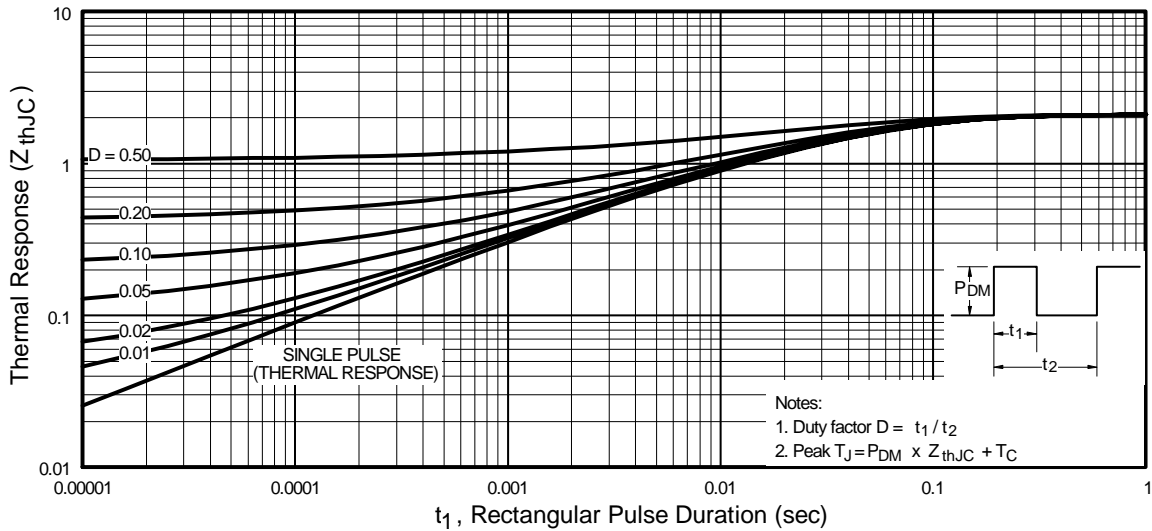

Fig. 6 - Maximum Effective Transient Thermal Impedance, Junction-to-Case

IRG4BC20WPbF

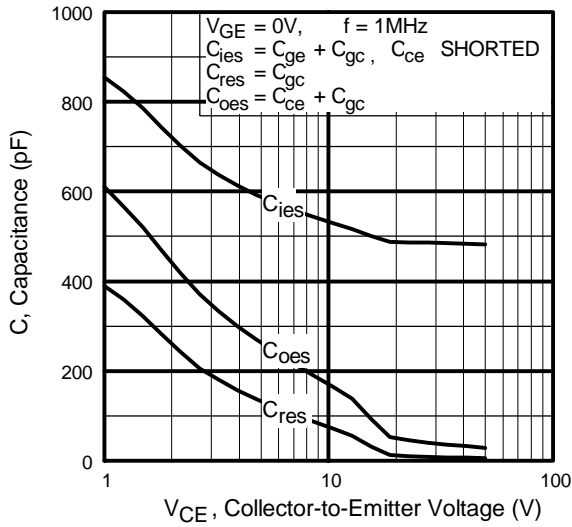

Fig. 7 - Typical Capacitance vs. Collector-to-Emitter Voltage

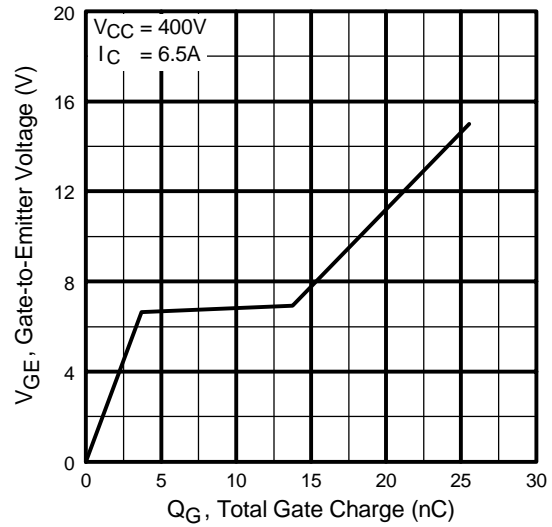

Fig. 8 - Typical Gate Charge vs. Gate-to-Emitter Voltage

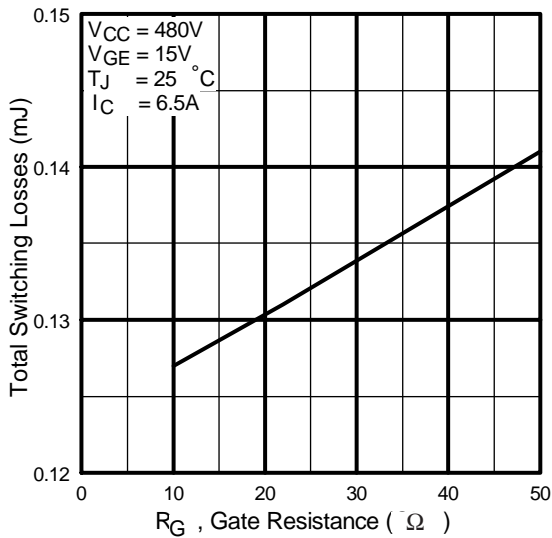

Fig. 9 - Typical Switching Losses vs. Gate Resistance

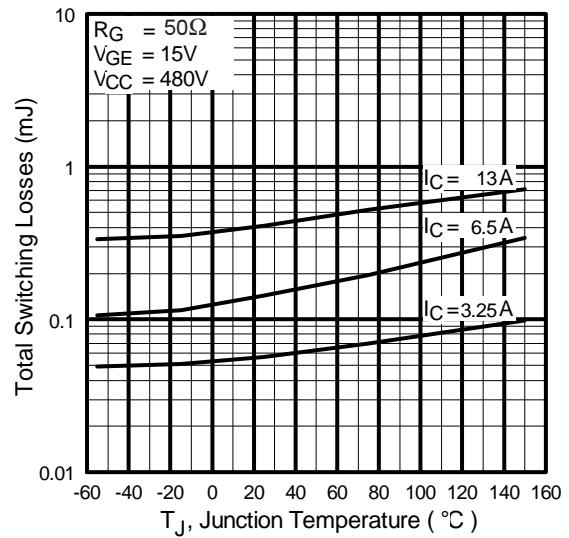

Fig. 10 - Typical Switching Losses vs. Junction Temperature

IRG4BC20WPbF

International
IR Rectifier

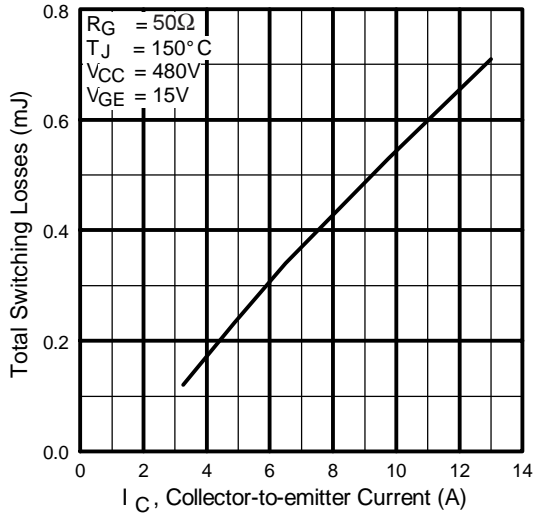

Fig. 11 - Typical Switching Losses vs. Collector-to-Emitter Current

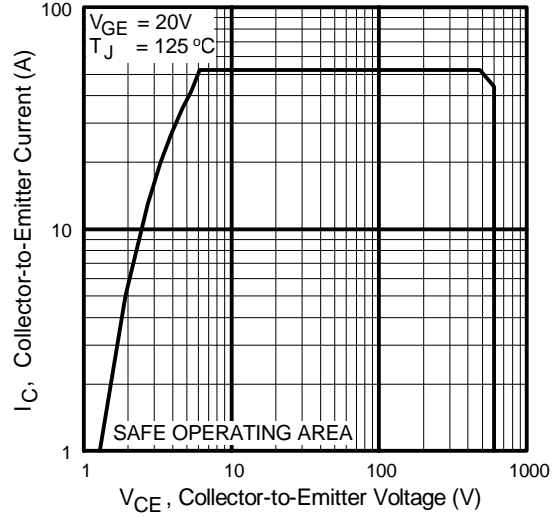

Fig. 12 - Turn-Off SOA

IRG4BC20WPbF

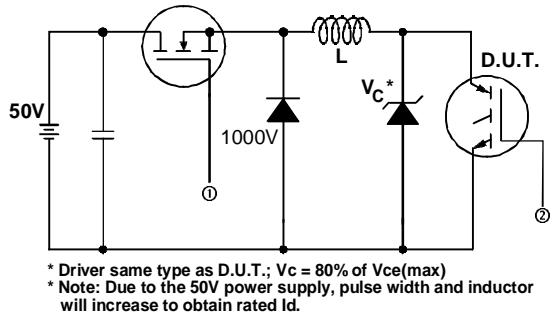

Fig. 13a - Clamped Inductive Load Test Circuit

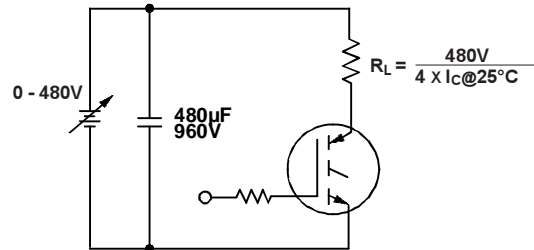

Fig. 13b - Pulsed Collector Current Test Circuit

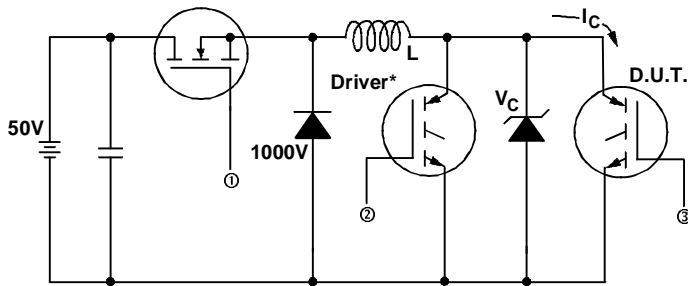

Fig. 14a - Switching Loss Test Circuit

* Driver same type as D.U.T., $V_C = 480V$

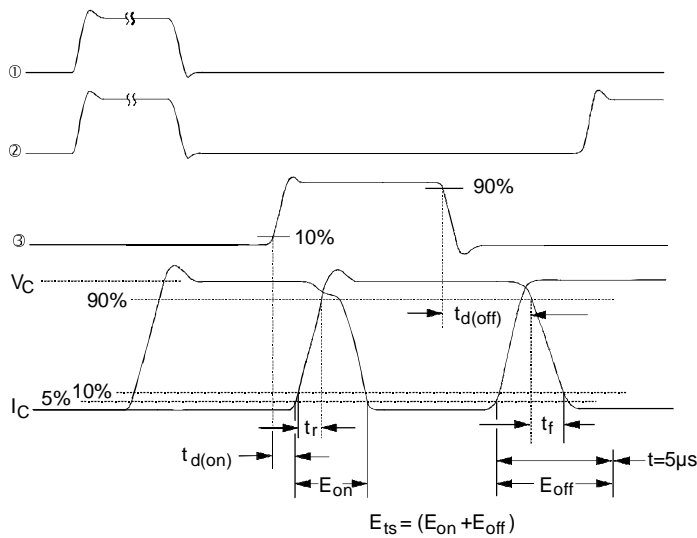

Fig. 14b - Switching Loss Waveforms

IRG4BC20WPbF



TO-220AB Package Outline

Dimensions are shown in millimeters (inches)

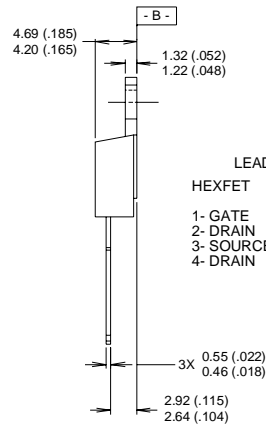
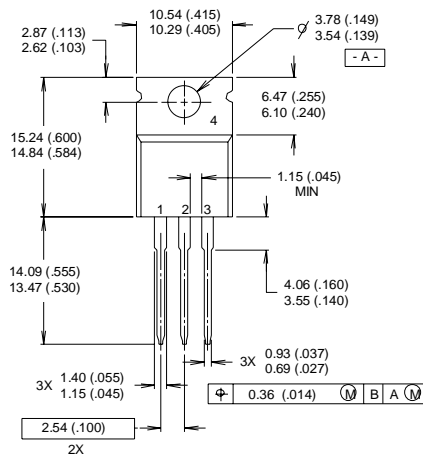

LEAD ASSIGNMENTS	
HEXFET	IGBTs, CoPACK
1- GATE	1- GATE
2- DRAIN	2- COLLECTOR
3- SOURCE	3- EMITTER
4- DRAIN	4- COLLECTOR

NOTES:

- 1 DIMENSIONING & TOLERANCING PER ANSI Y14.5M, 1982.
- 2 CONTROLLING DIMENSION : INCH
- 3 OUTLINE CONFORMS TO JEDEC OUTLINE TO-220AB.
- 4 HEATSINK & LEAD MEASUREMENTS DO NOT INCLUDE BURRS.

TO-220AB Part Marking Information

EXAMPLE: THIS IS AN IRF1010
 LOT CODE 1789
 ASSEMBLED ON WW 19, 1997
 IN THE ASSEMBLY LINE "C"
Note: "P" in assembly line position indicates "Lead-Free"

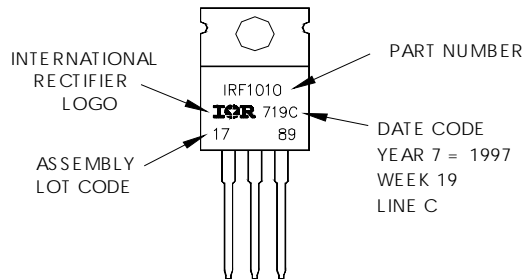

Data and specifications subject to change without notice.



IR WORLD HEADQUARTERS: 233 Kansas St., El Segundo, California 90245, USA Tel: (310) 252-7105
 TAC Fax: (310) 252-7903

Visit us at www.irf.com for sales contact information. 07/04
www.irf.com

Note: For the most current drawings please refer to the IR website at:
<http://www.irf.com/package/>

单击下面可查看定价，库存，交付和生命周期等信息

[>>Infineon Technologies\(英飞凌\)](#)