

IRF6893MPbF

IRF6893MTRPbF

DirectFET[®]*plus* MOSFET with Schottky Diode ②

- RoHs Compliant Containing No Lead and Bromide ①
- Integrated Monolithic Schottky Diode
- Low Profile (<0.7 mm)
- Dual Sided Cooling Compatible ①
- Low Package Inductance
- Optimized for High Frequency Switching ①
- Ideal for CPU Core DC-DC Converters
- Optimized for Sync. FET socket of Sync. Buck Converter①
- Low Conduction and Switching Losses
- Compatible with existing Surface Mount Techniques ①
- 100% Rg tested
- Footprint compatible to DirectFET™

Typical values (unless otherwise specified)

V _{DS}	V _{GS}	R _{DS(on)}	R _{DS(on)}		
25V max	±16V max	1.2mΩ @ 10V	1.6mΩ @ 4.5V		
Q _{g tot}	Q _{gd}	Q _{gs2}	Q _{rr}	Q _{oss}	V _{gs(th)}
25nC	8.5nC	2.5nC	36nC	29nC	1.6V

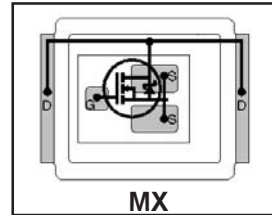

Applicable DirectFET Outline and Substrate Outline (see p.7,8 for details)①

SQ	SX	ST		MQ	MX	MT	MP			
----	----	----	--	----	-----------	----	----	--	--	--

Description

The IRF6893MPbF combines the latest HEXFET[®] Power MOSFET Silicon technology with the advanced DirectFET™ packaging to achieve the lowest on-state resistance in a package that has the footprint of a SO-8 and less than 0.7 mm profile. The DirectFET package is compatible with existing layout geometries used in power applications, PCB assembly equipment and vapor phase, infra-red or convection soldering techniques. Application note AN-1035 is followed regarding the manufacturing methods and processes. The DirectFET package allows dual sided cooling to maximize thermal transfer in power systems, improving previous best thermal resistance by 80%.

The IRF6893MPbF balances industry leading on-state resistance while minimizing gate charge along with low gate resistance to reduce both conduction and switching losses. This part contains an integrated Schottky diode to reduce the Q_{rr} of the body drain diode further reducing the losses in a Synchronous Buck circuit. The reduced losses make this product ideal for high frequency/high efficiency DC-DC converters that power high current loads such as the latest generation of microprocessors. The IRF6893MPbF has been optimized for parameters that are critical in synchronous buck converter's Sync FET sockets.

Absolute Maximum Ratings

	Parameter	Max.	Units
V _{DS}	Drain-to-Source Voltage	25	V
V _{GS}	Gate-to-Source Voltage	±16	
I _D @ T _A = 25°C	Continuous Drain Current, V _{GS} @ 10V ③	29	A
I _D @ T _A = 70°C	Continuous Drain Current, V _{GS} @ 10V ③	23	
I _D @ T _C = 25°C	Continuous Drain Current, V _{GS} @ 10V ④	168	
I _{DM}	Pulsed Drain Current ⑤	230	
E _{AS}	Single Pulse Avalanche Energy ⑥	370	mJ
I _{AR}	Avalanche Current ⑤	23	A

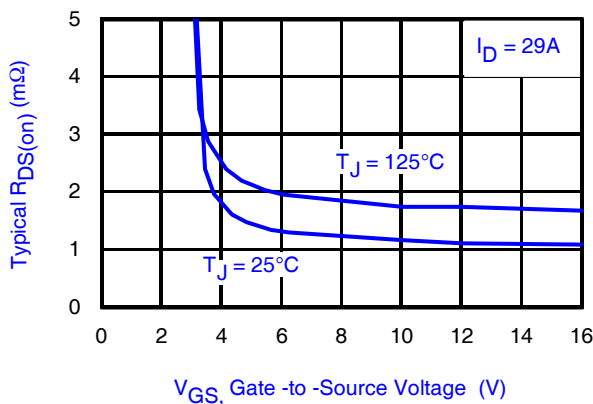

Fig 1. Typical On-Resistance vs. Gate Voltage

Notes:

- ① Click on this section to link to the appropriate technical paper.
- ② Click on this section to link to the DirectFET Website.
- ③ Surface mounted on 1 in. square Cu board, steady state.

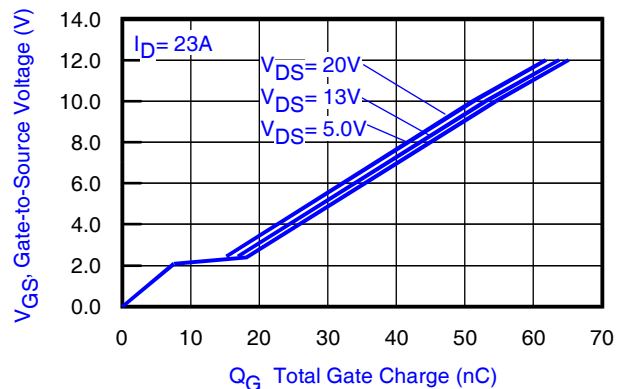

Fig 2. Typical Total Gate Charge vs. Gate-to-Source Voltage

- ④ T_C measured with thermocouple mounted to top (Drain) of part.
- ⑤ Repetitive rating; pulse width limited by max. junction temperature.
- ⑥ Starting T_J = 25°C, L = 1.4mH, R_G = 50Ω, I_{AS} = 23A.

Static @ T_J = 25°C (unless otherwise specified)

	Parameter	Min.	Typ.	Max.	Units	Conditions
BV _{DSS}	Drain-to-Source Breakdown Voltage	25	—	—	V	V _{GS} = 0V, I _D = 1.0mA
ΔBV _{DSS} /ΔT _J	Breakdown Voltage Temp. Coefficient	—	0.02	—	V/°C	I _D = 10mA (25°C-125°C)
R _{DS(on)}	Static Drain-to-Source On-Resistance	—	1.2	1.6	mΩ	V _{GS} = 10V, I _D = 29A ⑦
		—	1.6	2.1		V _{GS} = 4.5V, I _D = 23A ⑦
V _{GS(th)}	Gate Threshold Voltage	1.1	1.6	2.1	V	V _{DS} = V _{GS} , I _D = 100μA
ΔV _{GS(th)} /ΔT _J	Gate Threshold Voltage Coefficient	—	-3.9	—	mV/°C	V _{DS} = V _{GS} , I _D = 10mA
I _{DSS}	Drain-to-Source Leakage Current	—	—	250	μA	V _{DS} = 20V, V _{GS} = 0V
I _{GSS}	Gate-to-Source Forward Leakage	—	—	100	nA	V _{GS} = 16V
	Gate-to-Source Reverse Leakage	—	—	-100		V _{GS} = -16V
g _{fs}	Forward Transconductance	110	—	—	S	V _{DS} = 13V, I _D = 23A
Q _g	Total Gate Charge	—	25	38	nC	V _{DS} = 13V V _{GS} = 4.5V I _D = 23A
Q _{gs1}	Pre-V _{th} Gate-to-Source Charge	—	5.9	—		
Q _{gs2}	Post-V _{th} Gate-to-Source Charge	—	2.5	—		
Q _{gd}	Gate-to-Drain Charge	—	8.5	—		
Q _{gdr}	Gate Charge Overdrive	—	8.1	—		
Q _{sw}	Switch Charge (Q _{gs2} + Q _{gd})	—	11	—		
Q _{oss}	Output Charge	—	29	—	nC	V _{DS} = 16V, V _{GS} = 0V
R _G	Gate Resistance	—	0.47	—	Ω	
t _{d(on)}	Turn-On Delay Time	—	18	—	ns	V _{DD} = 13V, V _{GS} = 4.5V ⑦ I _D = 23A R _G = 1.8Ω
t _r	Rise Time	—	83	—		
t _{d(off)}	Turn-Off Delay Time	—	19	—		
t _f	Fall Time	—	33	—		
C _{iss}	Input Capacitance	—	3480	—	pF	V _{GS} = 0V V _{DS} = 13V f = 1.0MHz
C _{oss}	Output Capacitance	—	1140	—		
C _{riss}	Reverse Transfer Capacitance	—	210	—		

Diode Characteristics

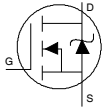
	Parameter	Min.	Typ.	Max.	Units	Conditions
I _S	Continuous Source Current (Body Diode)	—	—	126	A	MOSFET symbol showing the integral reverse p-n junction diode. 
I _{SM}	Pulsed Source Current (Body Diode) ⑤	—	—	230		
V _{SD}	Diode Forward Voltage	—	—	0.75	V	T _J = 25°C, I _S = 23A, V _{GS} = 0V ⑦
t _{rr}	Reverse Recovery Time	—	22	33	ns	T _J = 25°C, I _F = 23A
Q _{rr}	Reverse Recovery Charge	—	36	54	nC	di/dt = 400A/μs ⑦

Notes:

⑦ Pulse width ≤ 400μs; duty cycle ≤ 2%.

Absolute Maximum Ratings

	Parameter	Max.	Units
$P_D @ T_A = 25^\circ\text{C}$	Power Dissipation	2.1	W
$P_D @ T_A = 70^\circ\text{C}$	Power Dissipation	1.3	
$P_D @ T_C = 25^\circ\text{C}$	Power Dissipation	69	
T_P	Peak Soldering Temperature	270	$^\circ\text{C}$
T_J	Operating Junction and	-40 to +150	
T_{STG}	Storage Temperature Range		

Thermal Resistance

	Parameter	Typ.	Max.	Units
$R_{\theta JA}$	Junction-to-Ambient ③	—	60	$^\circ\text{C/W}$
$R_{\theta JA}$	Junction-to-Ambient ③	12.5	—	
$R_{\theta JA}$	Junction-to-Ambient ③	20	—	
$R_{\theta JC}$	Junction-to-Case ④⑤	—	1.8	
$R_{\theta J-PCB}$	Junction-to-PCB Mounted ⑥	1.0	—	
	Linear Derating Factor	0.017		$\text{W}/^\circ\text{C}$

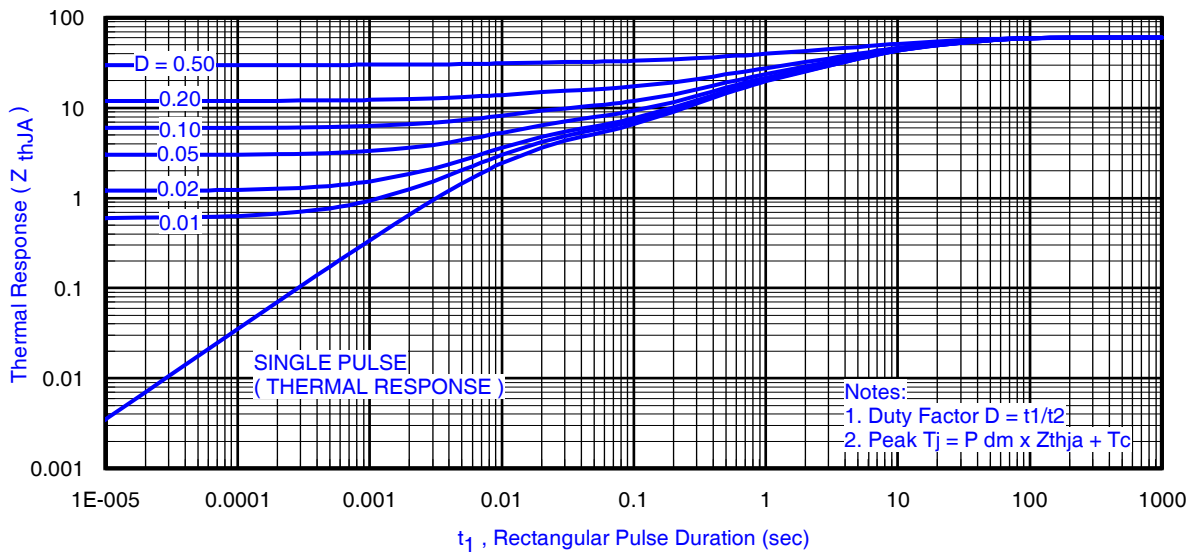

Fig 3. Maximum Effective Transient Thermal Impedance, Junction-to-Ambient ③

Notes:

- ③ Used double sided cooling , mounting pad with large heatsink.
- ④ R_{θ} is measured at T_J of approximately 90°C .
- ⑤ Mounted on minimum footprint full size board with metalized back and with small clip heatsink.



③ Surface mounted on 1 in. square Cu (still air).

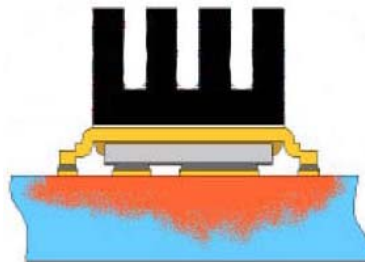

⑤ Mounted to a PCB with small clip heatsink (still air)

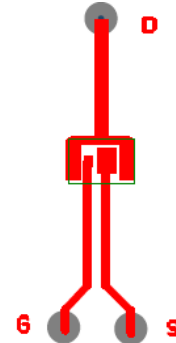

⑥ Mounted on minimum footprint full size board with metalized back and with small clip heatsink (still air)

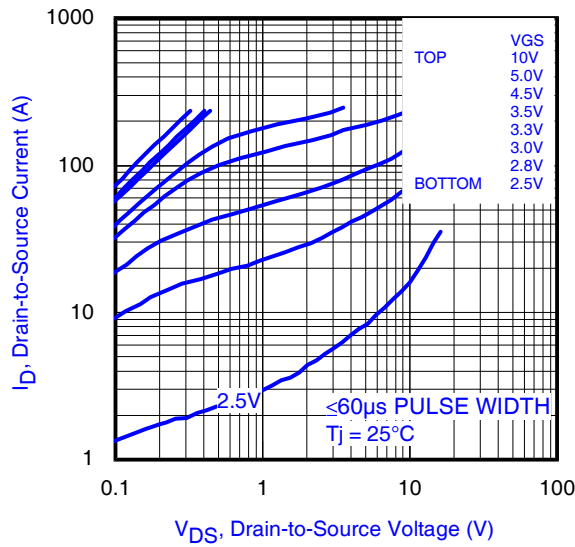

Fig 4. Typical Output Characteristics

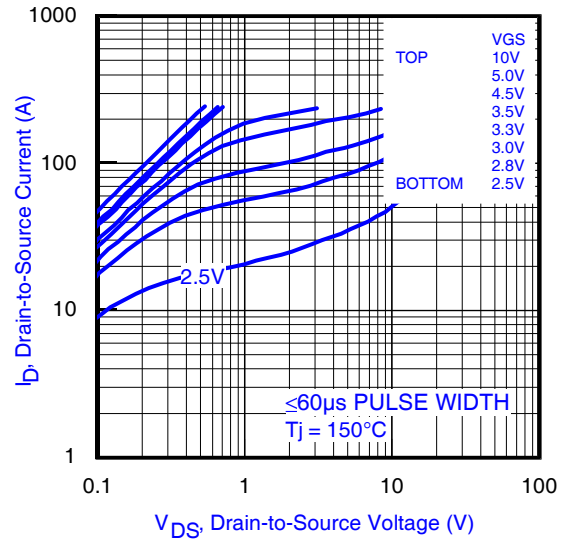

Fig 5. Typical Output Characteristics

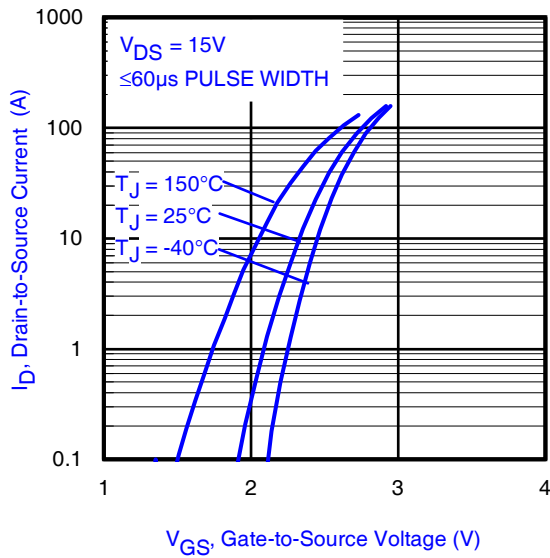

Fig 6. Typical Transfer Characteristics

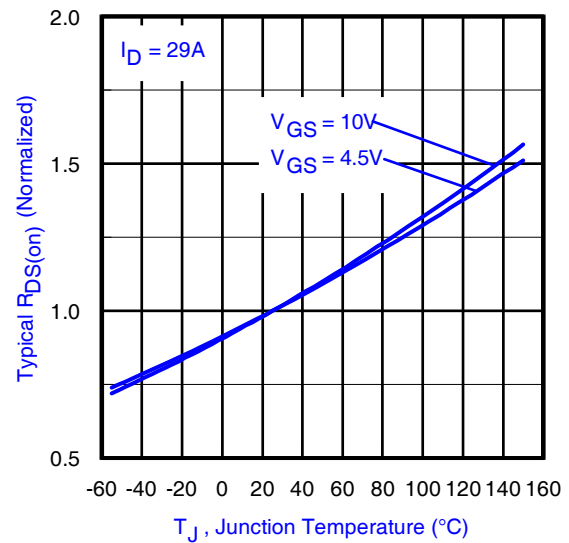

Fig 7. Normalized On-Resistance vs. Temperature

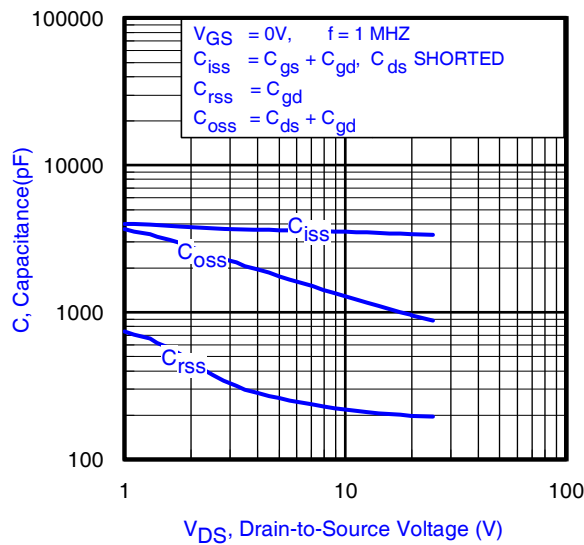

Fig 8. Typical Capacitance vs. Drain-to-Source Voltage

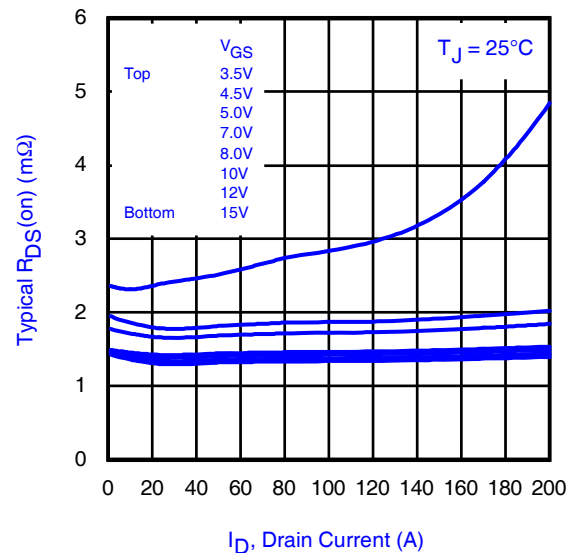

Fig 9. Typical On-Resistance vs. Drain Current and Gate Voltage

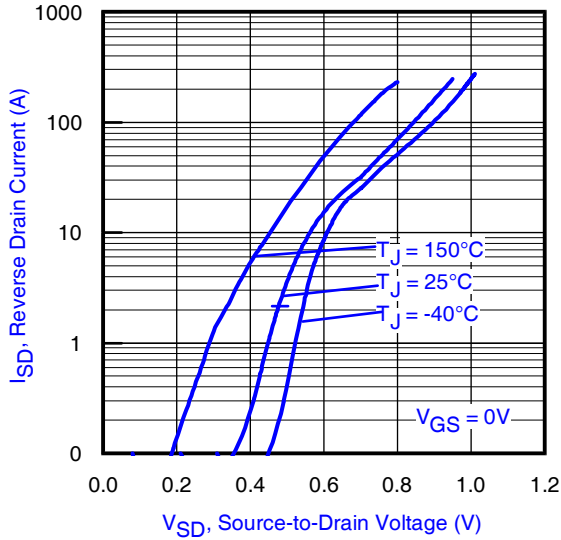

Fig 10. Typical Source-Drain Diode Forward Voltage

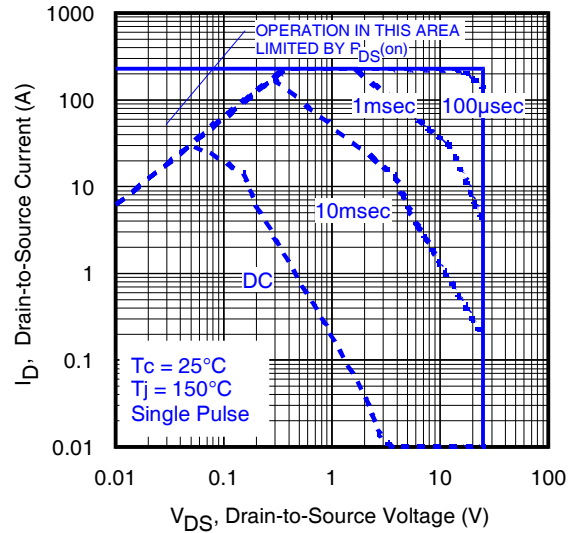

Fig 11. Maximum Safe Operating Area

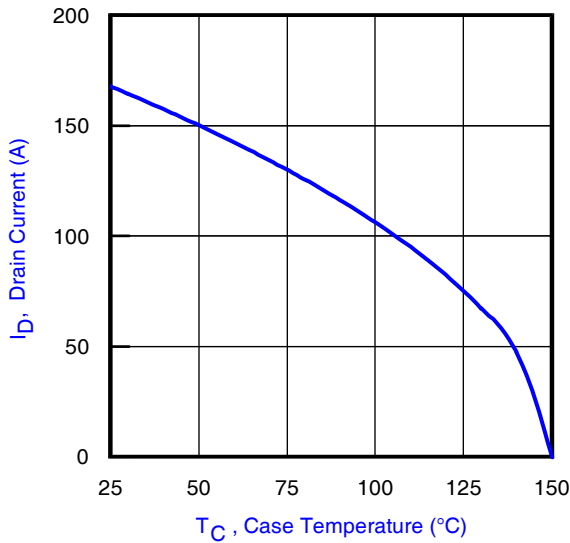

Fig 12. Maximum Drain Current vs. Case Temperature

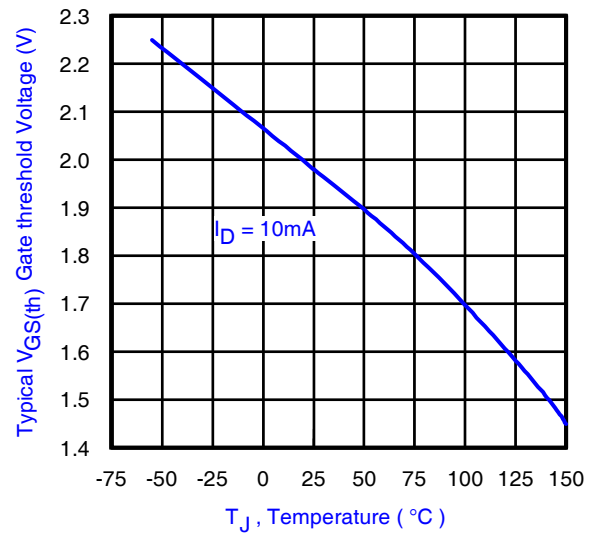

Fig 13. Typical Threshold Voltage vs. Junction Temperature

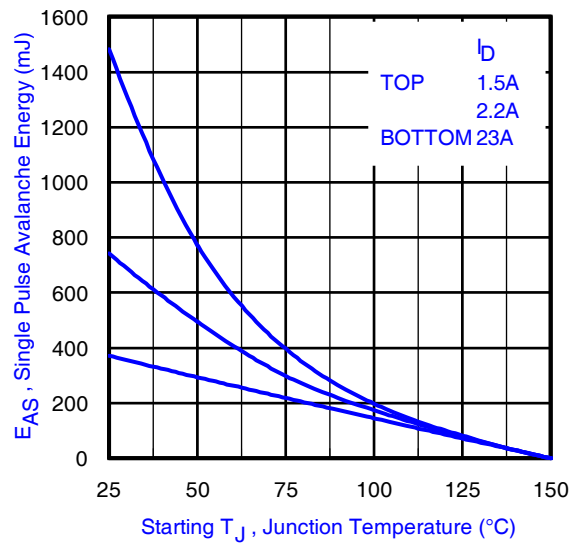

Fig 14. Maximum Avalanche Energy vs. Drain Current

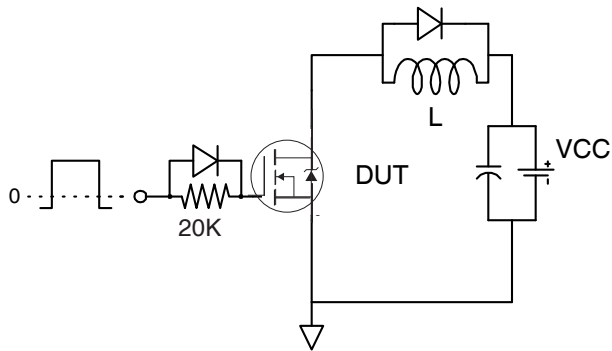

Fig 15a. Gate Charge Test Circuit

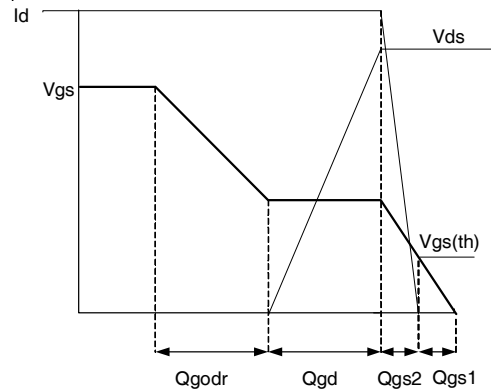

Fig 15b. Gate Charge Waveform

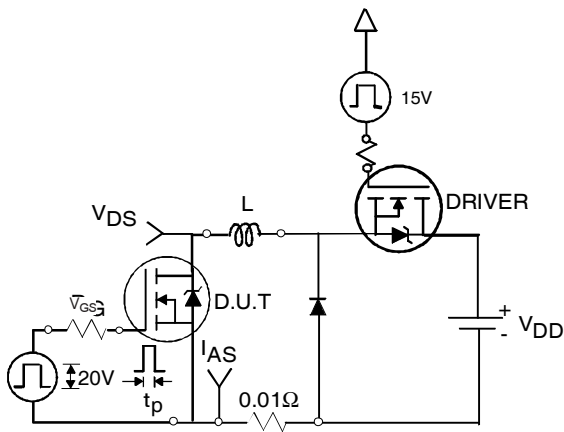

Fig 16a. Unclamped Inductive Test Circuit

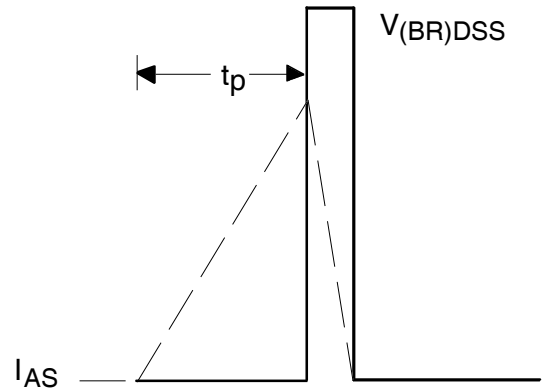

Fig 16b. Unclamped Inductive Waveforms

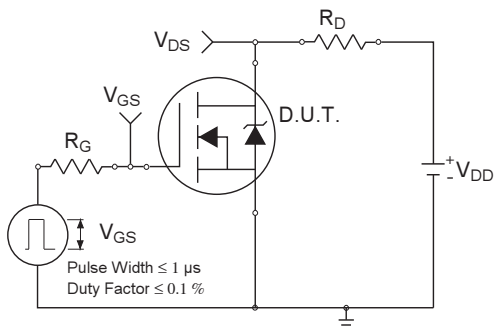

Fig 17a. Switching Time Test Circuit

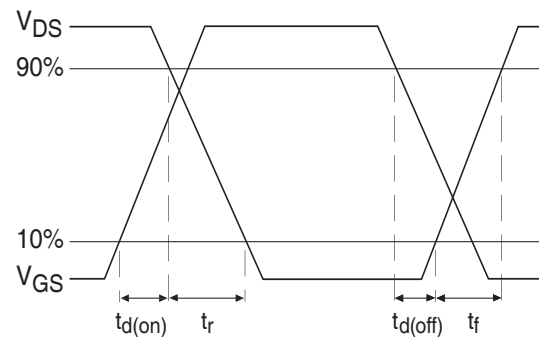

Fig 17b. Switching Time Waveforms

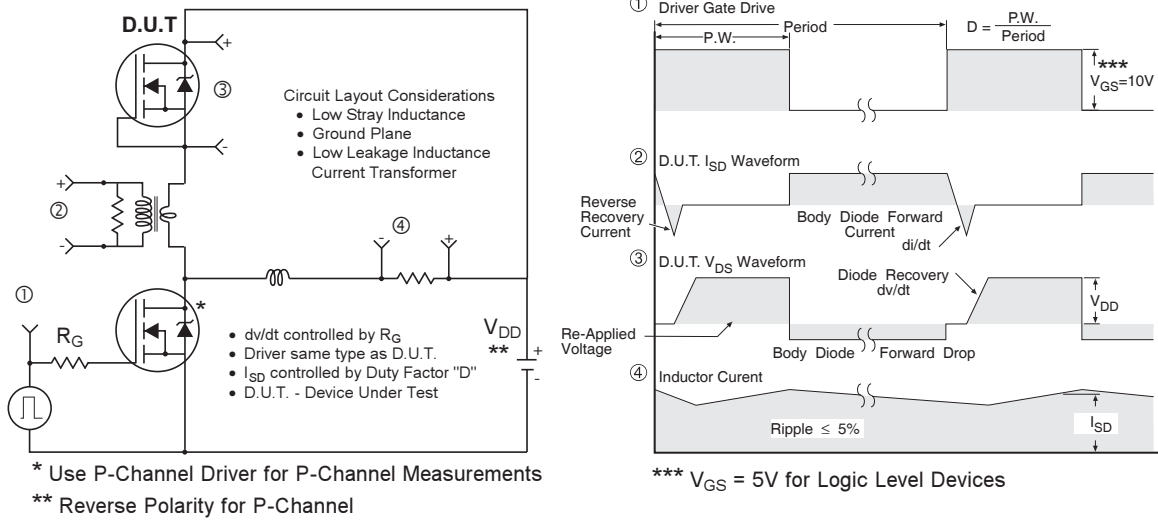
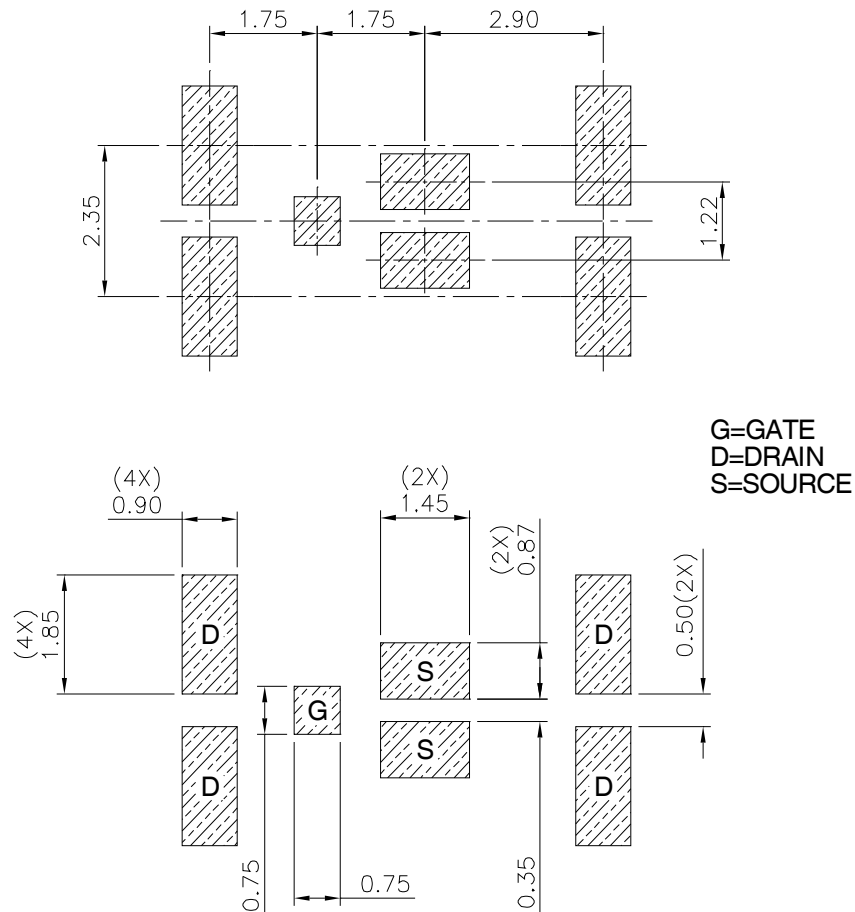

Fig 18. Diode Reverse Recovery Test Circuit for HEXFET® Power MOSFETs

**DirectFET®plus Board Footprint, MX Outline
(Medium Size Can, X-Designation).**

Please see DirectFET application note AN-1035 for all details regarding the assembly of DirectFET®plus.

This includes all recommendations for stencil and substrate designs.



Note: For the most current drawing please refer to IR website at: <http://www.irf.com/package/>

IRF6893MTRPbF

DirectFET^{®plus} Outline Dimension, MX Outline (Medium Size Can, X-Designation).

Please see DirectFET application note AN-1035 for all details regarding the assembly of DirectFET^{®plus}. This includes all recommendations for stencil and substrate designs.

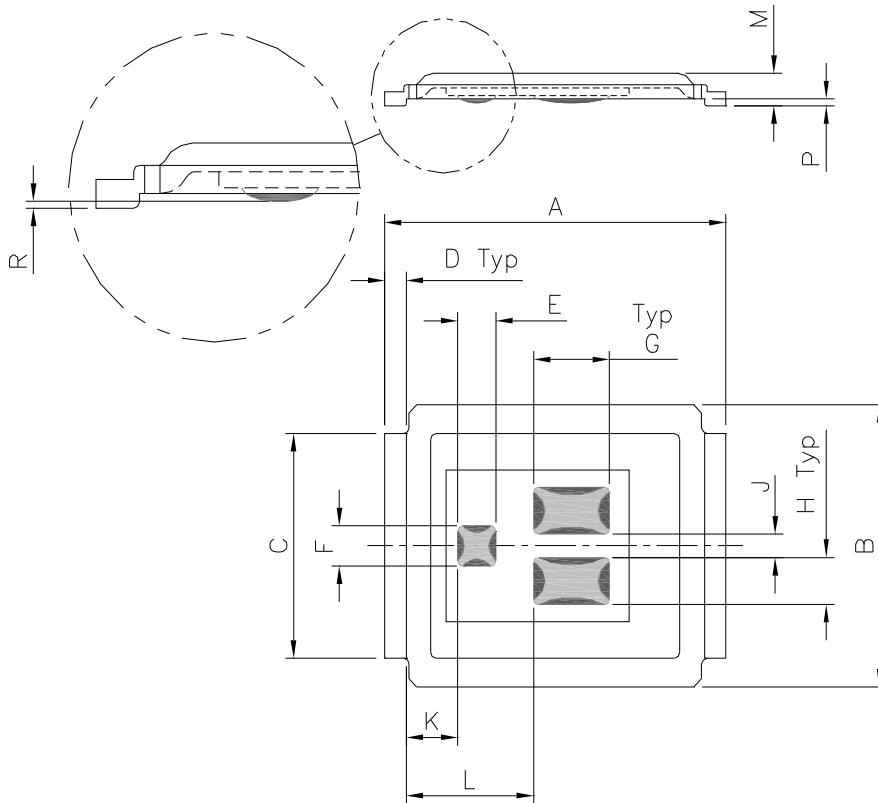

DIMENSIONS				
CODE	METRIC		IMPERIAL	
	MIN	MAX	MIN	MAX
A	6.25	6.35	0.246	0.250
B	4.80	5.05	0.189	0.199
C	3.85	3.95	0.152	0.156
D	0.35	0.45	0.014	0.018
E	0.68	0.72	0.027	0.028
F	0.68	0.72	0.027	0.028
G	1.38	1.42	0.054	0.056
H	0.80	0.84	0.031	0.033
J	0.38	0.42	0.015	0.017
K	0.88	1.02	0.035	0.040
L	2.28	2.42	0.090	0.095
M	0.52	0.62	0.020	0.024
R	0.02	0.08	0.0008	0.0031
P	0.08	0.17	0.003	0.007

DirectFET^{®plus} Part Marking

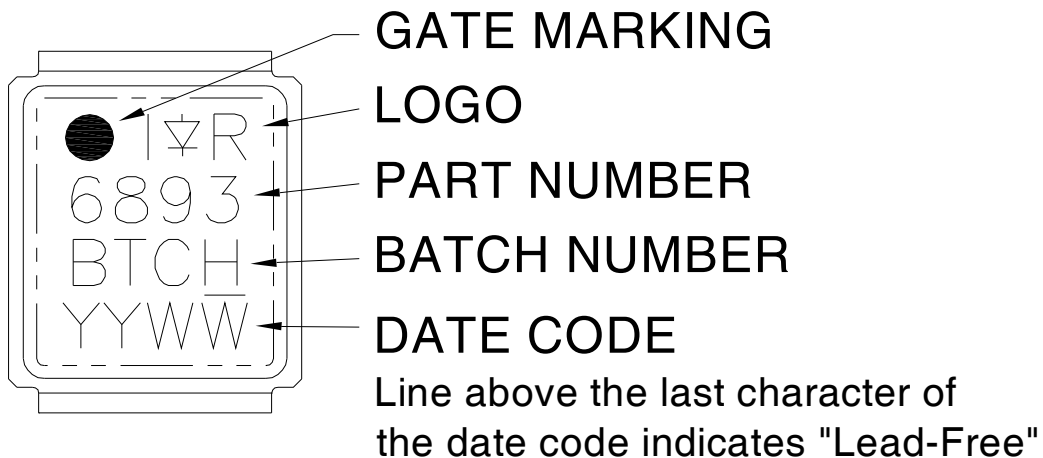

Note: For the most current drawing please refer to IR website at: <http://www.irf.com/package/>

DirectFET[®]plus Tape & Reel Dimension (Showing component orientation).

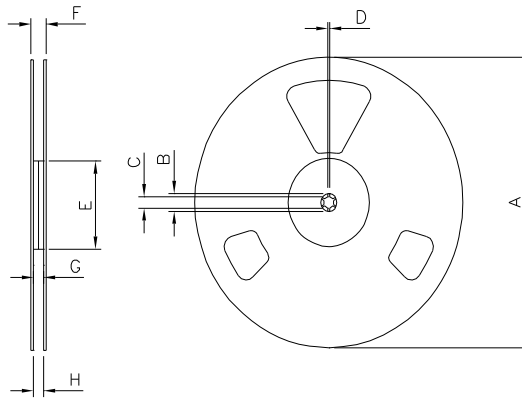

NOTE: Controlling dimensions in mm
 Std reel quantity is 4800 parts. (ordered as IRF6893MTRPBF). For 1000 parts on 7" reel, order IRF6893MTR1PBF

REEL DIMENSIONS								
CODE	STANDARD OPTION (QTY 4800)				TR1 OPTION (QTY 1000)			
	METRIC		IMPERIAL		METRIC		IMPERIAL	
A	330.0	N.C	12.992	N.C	177.77	N.C	6.9	N.C
B	20.2	N.C	0.795	N.C	19.06	N.C	0.75	N.C
C	12.8	13.2	0.504	0.520	13.5	12.8	0.53	0.50
D	1.5	N.C	0.059	N.C	1.5	N.C	0.059	N.C
E	100.0	N.C	3.937	N.C	58.72	N.C	2.31	N.C
F	N.C	18.4	N.C	0.724	N.C	13.50	N.C	0.53
G	12.4	14.4	0.488	0.567	11.9	12.01	0.47	N.C
H	11.9	15.4	0.469	0.606	11.9	12.01	0.47	N.C

LOADED TAPE FEED DIRECTION

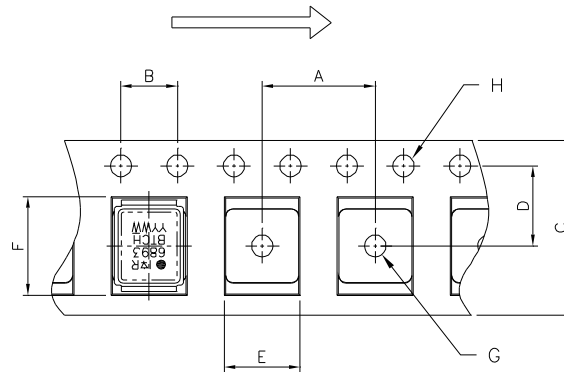

NOTE: CONTROLLING DIMENSIONS IN MM

CODE	DIMENSIONS			
	METRIC		IMPERIAL	
A	7.90	8.10	0.311	0.319
B	3.90	4.10	0.154	0.161
C	11.90	12.30	0.469	0.484
D	5.45	5.55	0.215	0.219
E	5.10	5.30	0.201	0.209
F	6.50	6.70	0.256	0.264
G	1.50	N.C	0.059	N.C
H	1.50	1.60	0.059	0.063

Data and specifications subject to change without notice.
 This product has been designed and qualified for the Consumer market.
 Qualification Standards can be found on IR's Web site.

单击下面可查看定价，库存，交付和生命周期等信息

[>>Infineon Technologies\(英飞凌\)](#)