

# BFR340F

## Low profile silicon NPN RF bipolar transistor



### Product description

The BFR340F is a low noise device based on Si that is part of Infineon's established third generation RF bipolar transistor family. Its low current and high breakdown voltage characteristics make the device suitable for oscillators applications for frequencies as high as 3.5 GHz. It remains cost competitive without compromising on ease of use.



### Feature list

- Minimum noise figure  $NF_{min} = 1$  dB at 1.9 GHz, 1.5 V, 1 mA
- High gain  $G_{ms} = 16.5$  dB at 1.8 GHz, 3 V, 5 mA
- $OIP_3 = 13$  dBm at 1.8 GHz, 3 V, 5 mA

### Product validation

Qualified for industrial applications according to the relevant tests of JEDEC47/20/22.

### Potential applications

- Low noise amplifiers (LNAs) for FM and AM radio
- LNAs for sub-1 GHz ISM band applications

### Device information

**Table 1** Part information

Product name / Ordering code	Package	Pin configuration			Marking	Pieces / Reel
BFR340F / BFR340FH6327XTSA1	TSFP-3-1	1 = B	2 = E	3 = C	FAs	3000

**Attention:** ESD (Electrostatic discharge) sensitive device, observe handling precautions

---

**Table of contents**

**Table of contents**

	<b>Product description</b> .....	1
	<b>Feature list</b> .....	1
	<b>Product validation</b> .....	1
	<b>Potential applications</b> .....	1
	<b>Device information</b> .....	1
	<b>Table of contents</b> .....	2
<b>1</b>	<b>Absolute maximum ratings</b> .....	3
<b>2</b>	<b>Thermal characteristics</b> .....	4
<b>3</b>	<b>Electrical characteristics</b> .....	5
3.1	DC characteristics .....	5
3.2	General AC characteristics .....	5
3.3	Frequency dependent AC characteristics .....	6
3.4	Characteristic AC diagrams .....	8
<b>4</b>	<b>Package information TSFP-3-1</b> .....	14
	<b>Revision history</b> .....	15
	<b>Disclaimer</b> .....	16

**Absolute maximum ratings**

**1 Absolute maximum ratings**

**Table 2 Absolute maximum ratings at  $T_A = 25\text{ °C}$  (unless otherwise specified)**

Parameter	Symbol	Values		Unit	Note or test condition
		Min.	Max.		
Collector emitter voltage	$V_{CEO}$	-	6	V	Open base
Collector emitter voltage	$V_{CES}$		15		E-B short circuited
Collector base voltage	$V_{CBO}$		15		Open emitter
Emitter base voltage	$V_{EBO}$		2		Open collector
Base current	$I_B$		2	mA	-
Collector current	$I_C$		20		
Total power dissipation <sup>1)</sup>	$P_{tot}$		75	mW	$T_S \leq 110\text{ °C}$
Junction temperature	$T_J$		150	°C	-
Storage temperature	$T_{Stg}$	-55			

**Attention:** *Stresses above the max. values listed here may cause permanent damage to the device. Exposure to absolute maximum rating conditions for extended periods may affect device reliability. Exceeding only one of these values may cause irreversible damage to the integrated circuit.*

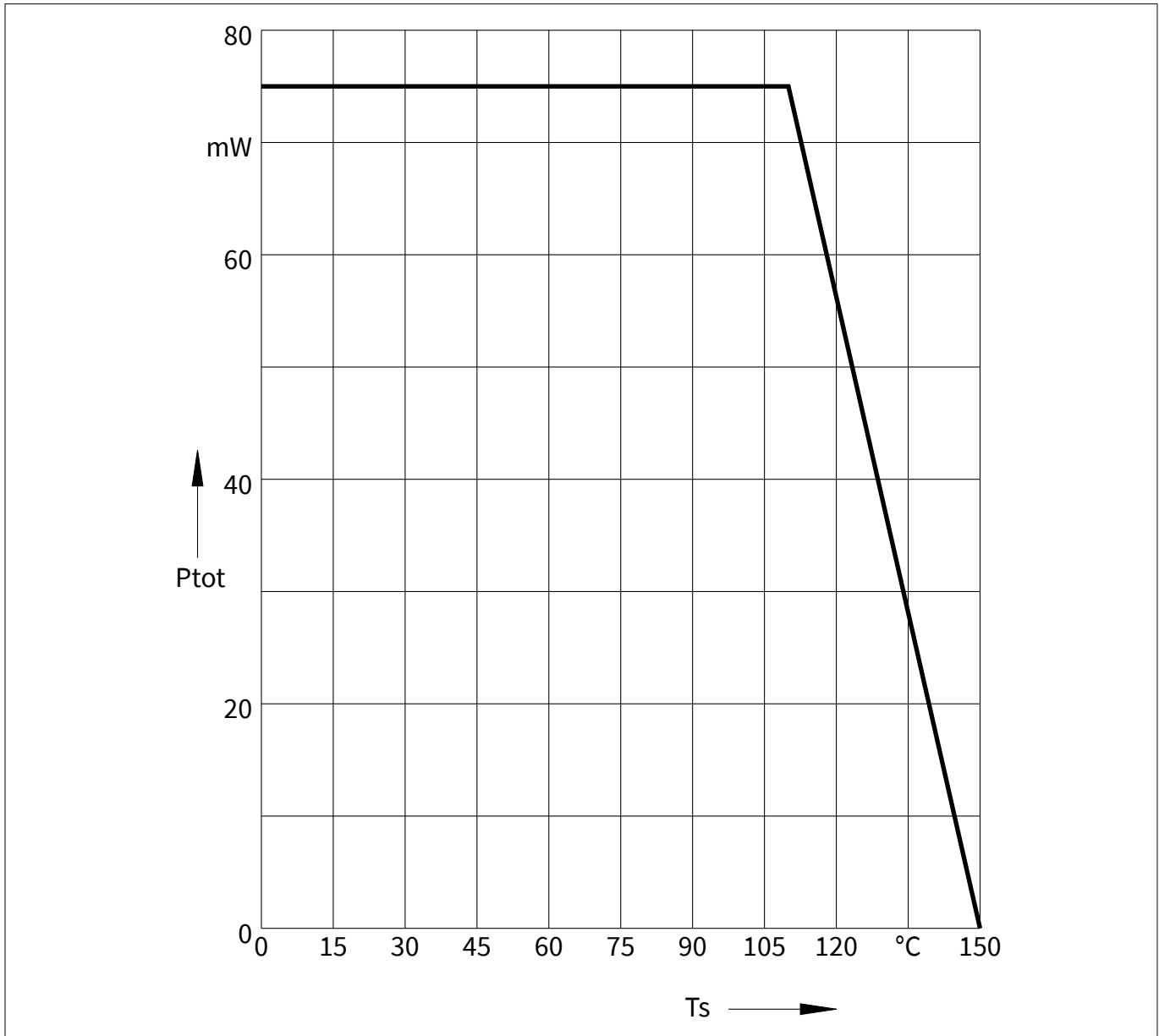
<sup>1</sup>  $T_S$  is the soldering point temperature.  $T_S$  is measured on the emitter lead at the soldering point of the PCB.

**Thermal characteristics**

**2 Thermal characteristics**

**Table 3 Thermal resistance**

Parameter	Symbol	Values			Unit	Note or test condition
		Min.	Typ.	Max.		
Junction - soldering point	$R_{thJS}$	-	530	-	K/W	-



**Figure 1 Total power dissipation  $P_{tot} = f(T_s)$**

**Electrical characteristics**

**3 Electrical characteristics**

**3.1 DC characteristics**

**Table 4 DC characteristics at  $T_A = 25\text{ °C}$  (unless otherwise specified)**

Parameter	Symbol	Values			Unit	Note or test condition
		Min.	Typ.	Max.		
Collector emitter breakdown voltage	$V_{(BR)CEO}$	6	9	–	V	$I_C = 1\text{ mA}$ , $I_B = 0$ , open base
Collector emitter leakage current	$I_{CES}$	–	1	30 <sup>2)</sup>	nA	$V_{CE} = 4\text{ V}$ , $V_{BE} = 0$ , E-B short circuited
			2	50 <sup>2)</sup>		$V_{CE} = 10\text{ V}$ , $V_{BE} = 0$ , $T_A = 85\text{ °C}$ , E-B short circuited
Collector base leakage current	$I_{CBO}$		1	30 <sup>2)</sup>		$V_{CB} = 4\text{ V}$ , $I_E = 0$ , open emitter
Emitter base leakage current	$I_{EBO}$		1	500 <sup>2)</sup>		$V_{EB} = 1\text{ V}$ , $I_C = 0$ , open collector
DC current gain	$h_{FE}$	90	120	160		$V_{CE} = 3\text{ V}$ , $I_C = 5\text{ mA}$ , pulse measured

**3.2 General AC characteristics**

**Table 5 General AC characteristics at  $T_A = 25\text{ °C}$**

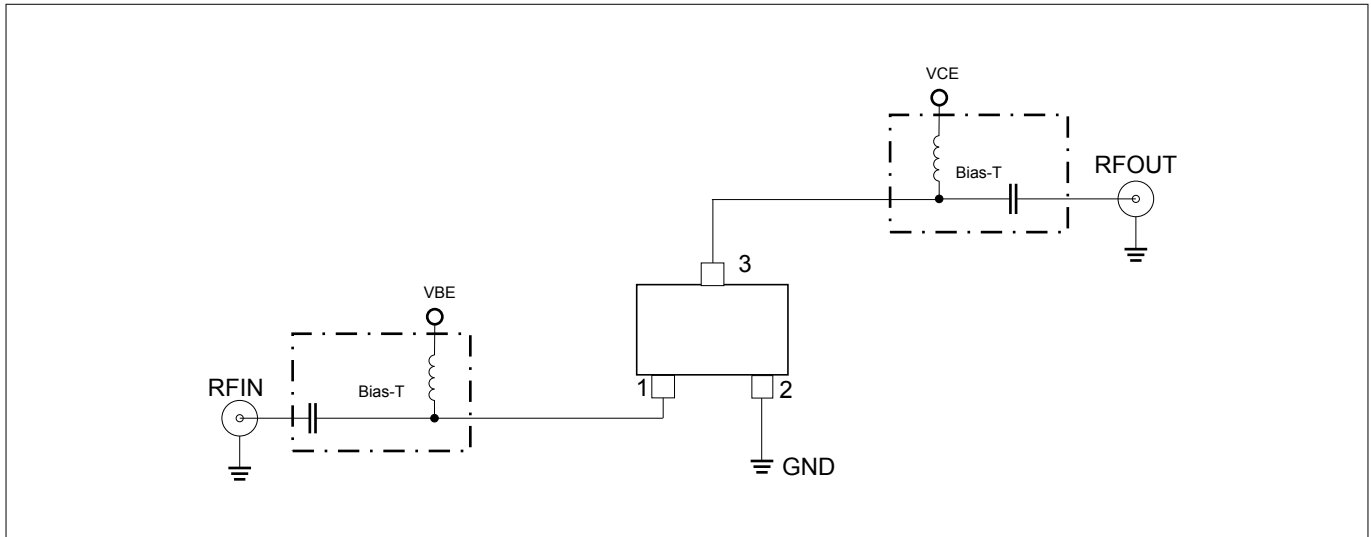
Parameter	Symbol	Values			Unit	Note or test condition
		Min.	Typ.	Max.		
Transition frequency	$f_T$	11	14	–	GHz	$V_{CE} = 3\text{ V}$ , $I_C = 6\text{ mA}$ , $f = 1\text{ GHz}$
Collector base capacitance	$C_{CB}$	–	0.21	0.4	pF	$V_{CB} = 5\text{ V}$ , $V_{BE} = 0$ , $f = 1\text{ MHz}$ , emitter grounded
Collector emitter capacitance	$C_{CE}$		0.17	–		$V_{CE} = 5\text{ V}$ , $V_{BE} = 0$ , $f = 1\text{ MHz}$ , base grounded
Emitter base capacitance	$C_{EB}$		0.11			$V_{EB} = 0.5\text{ V}$ , $V_{CB} = 0$ , $f = 1\text{ MHz}$ , collector grounded

<sup>2</sup> Maximum values not limited by the device but by the short cycle time of the 100% test.

**Electrical characteristics**

**3.3 Frequency dependent AC characteristics**

Measurement setup is a test fixture with Bias-T's in a 50 Ω system,  $T_A = 25\text{ °C}$ .



**Figure 2 Testing circuit**

**Table 6 AC characteristics,  $f = 100\text{ MHz}$**

Parameter	Symbol	Values			Unit	Note or test condition
		Min.	Typ.	Max.		
Power gain		-		-	dB	
<ul style="list-style-type: none"> <li>Maximum power gain</li> <li>Transducer gain</li> </ul>	$G_{ms}$ $ S_{21} ^2$		28 19			$I_C = 3\text{ mA}, V_{CE} = 1.5\text{ V}$
Noise figure						
<ul style="list-style-type: none"> <li>Minimum noise figure</li> </ul>	$NF_{min}$		0.9			$I_C = 3\text{ mA}, V_{CE} = 1.5\text{ V}$
Linearity					dBm	
<ul style="list-style-type: none"> <li>3rd order intercept point at output</li> <li>1 dB gain compression point at output</li> </ul>	$OIP_3$ $OP_{1dB}$		14 -3			$I_C = 5\text{ mA}, V_{CE} = 3\text{ V}, Z_S = Z_L = 50\text{ }\Omega$

**Table 7 AC characteristics,  $V_{CE} = 3\text{ V}, f = 1.8\text{ GHz}$**

Parameter	Symbol	Values			Unit	Note or test condition
		Min.	Typ.	Max.		
Power gain		-		-	dB	
<ul style="list-style-type: none"> <li>Maximum power gain</li> <li>Transducer gain</li> </ul>	$G_{ms}$ $ S_{21} ^2$		16.5 14			$I_C = 5\text{ mA}$
Linearity					dBm	
<ul style="list-style-type: none"> <li>3rd order intercept point at output</li> <li>1 dB gain compression point at output</li> </ul>	$OIP_3$ $OP_{1dB}$		13 -1			$I_C = 5\text{ mA}, Z_S = Z_L = 50\text{ }\Omega$

**Electrical characteristics**

**Table 8 AC characteristics,  $f = 1.9$  GHz**

Parameter	Symbol	Values			Unit	Note or test condition
		Min.	Typ.	Max.		
Power gain	$G_{ms}$ $ S_{21} ^2$	-	16.3	-	dB	$I_C = 5$ mA, $V_{CE} = 3$ V
<ul style="list-style-type: none"> <li>Maximum power gain</li> <li>Transducer gain</li> </ul>			13.4			
Noise figure	$NF_{min}$		1			$I_C = 1$ mA, $V_{CE} = 1.5$ V
<ul style="list-style-type: none"> <li>Minimum noise figure</li> </ul>						

**Table 9 AC characteristics,  $f = 2.4$  GHz**

Parameter	Symbol	Values			Unit	Note or test condition
		Min.	Typ.	Max.		
Power gain	$G_{ms}$ $ S_{21} ^2$	-	14.9	-	dB	$I_C = 5$ mA, $V_{CE} = 3$ V
<ul style="list-style-type: none"> <li>Maximum power gain</li> <li>Transducer gain</li> </ul>			11.6			
Noise figure	$NF_{min}$		1.2			$I_C = 1$ mA, $V_{CE} = 1.5$ V
<ul style="list-style-type: none"> <li>Minimum noise figure</li> </ul>						

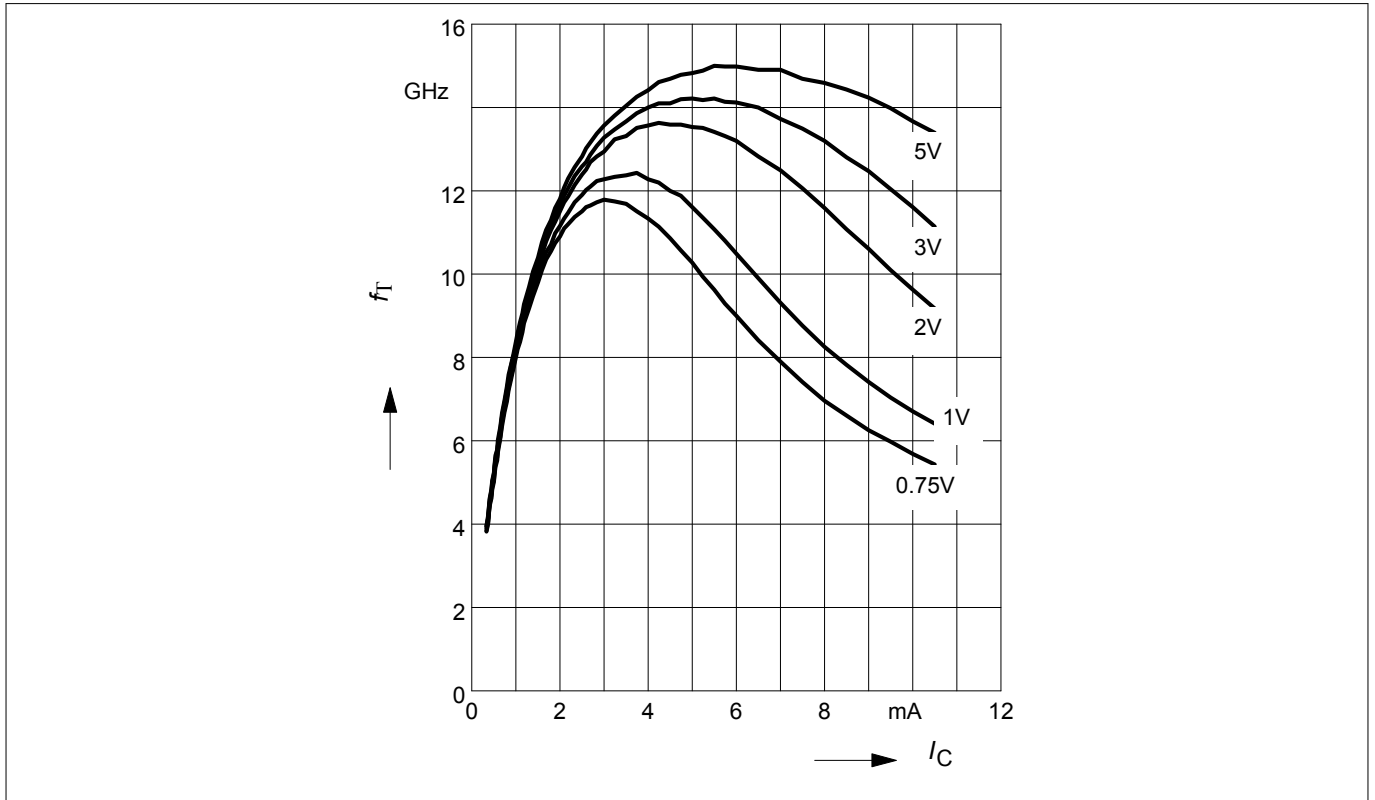
**Table 10 AC characteristics,  $V_{CE} = 3$  V,  $f = 3$  GHz**

Parameter	Symbol	Values			Unit	Note or test condition
		Min.	Typ.	Max.		
Power gain	$G_{ms}$ $ S_{21} ^2$	-	13	-	dB	$I_C = 5$ mA
<ul style="list-style-type: none"> <li>Maximum power gain</li> <li>Transducer gain</li> </ul>			10			

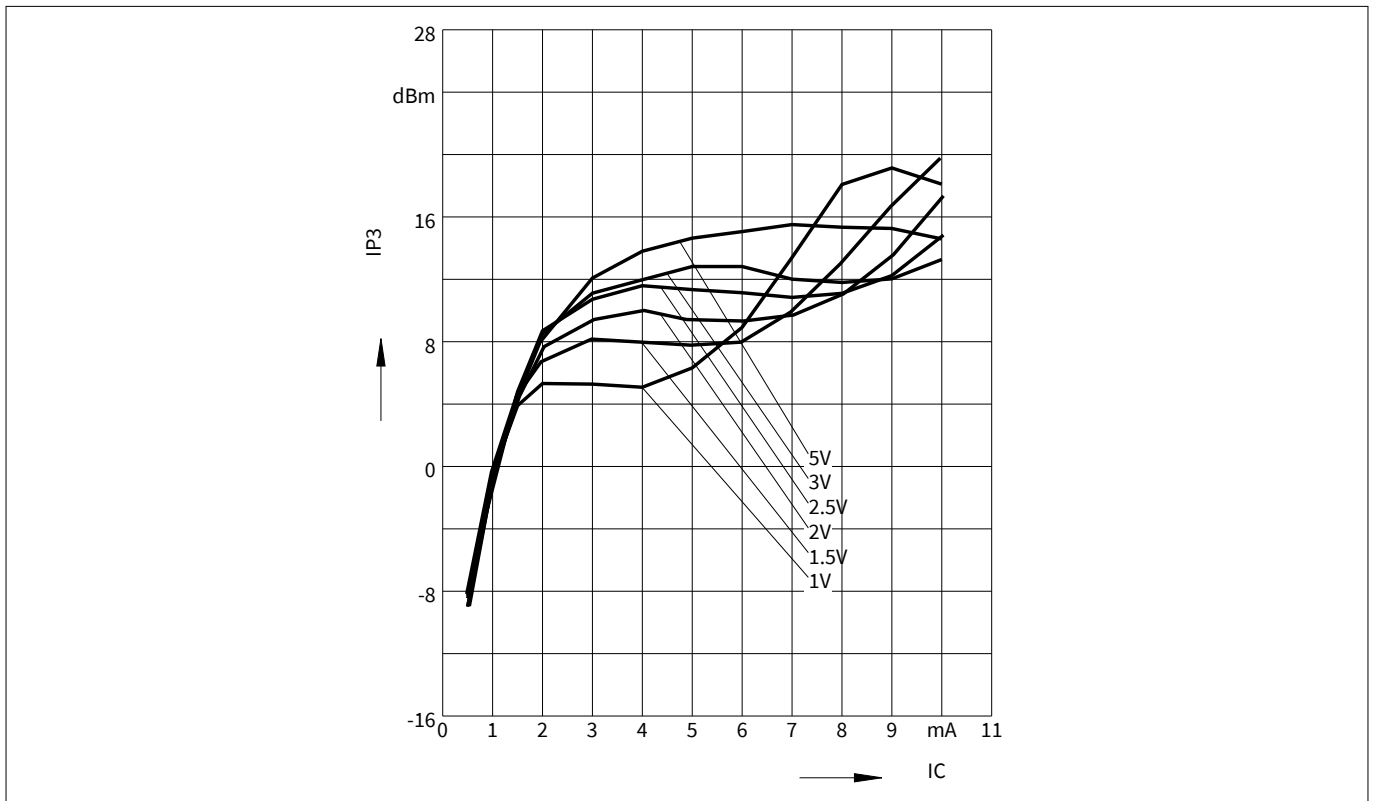
*Note:*  $G_{ms} = |S_{21}/S_{12}|$  for  $k < 1$ ;  $G_{ma} = |S_{21}/S_{12}|(k-(k^2-1)^{1/2})$  for  $k > 1$ . In order to get the  $NF_{min}$  values stated in this chapter, the test fixture losses have been subtracted from all measured results.  $OIP_3$  value depends on termination of all intermodulation frequency components. Termination used for this measurement is  $50 \Omega$  from 0.1 MHz to 6 GHz.

Electrical characteristics

**3.4 Characteristic AC diagrams**



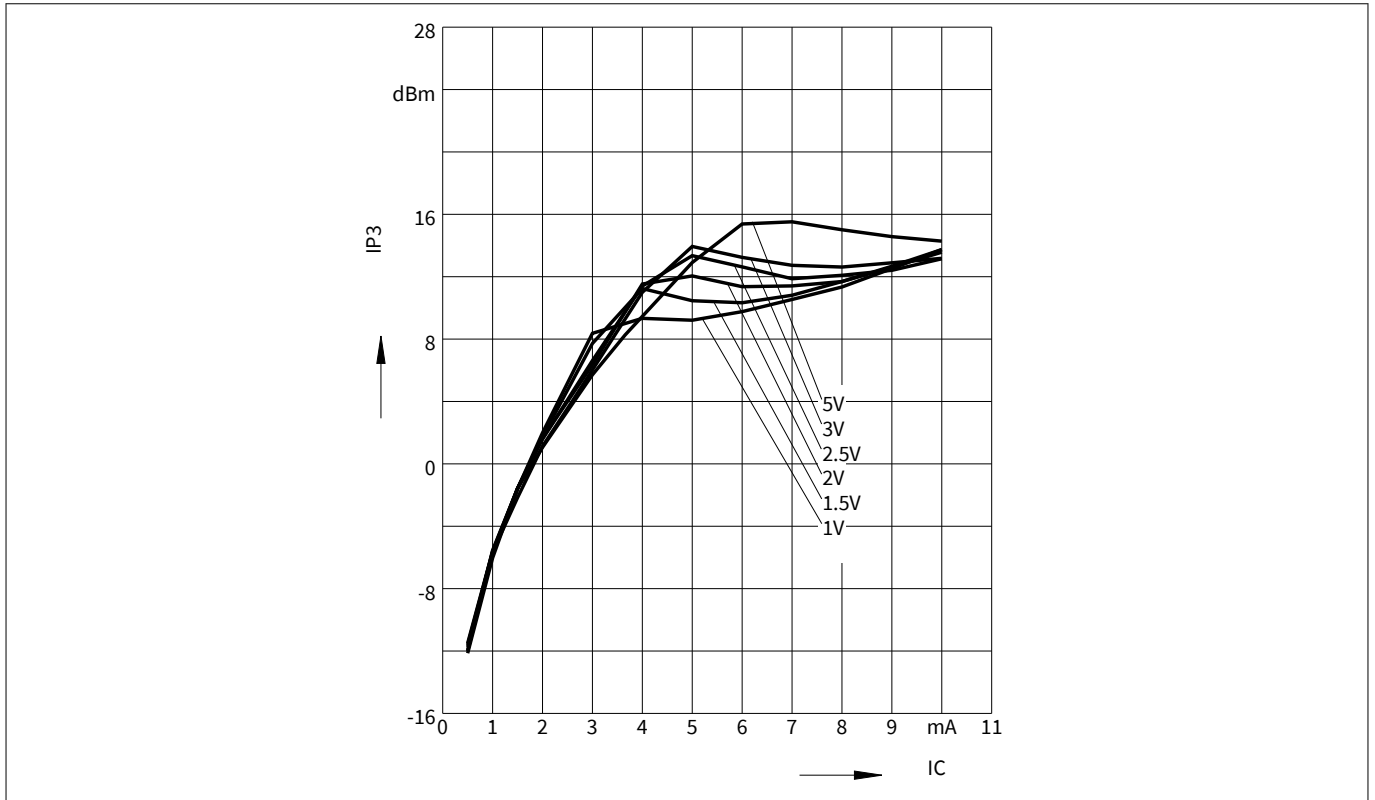
**Figure 3** Transition frequency  $f_T = f(I_C)$ ,  $f = 1 \text{ GHz}$ ,  $V_{CE} = \text{parameter}$



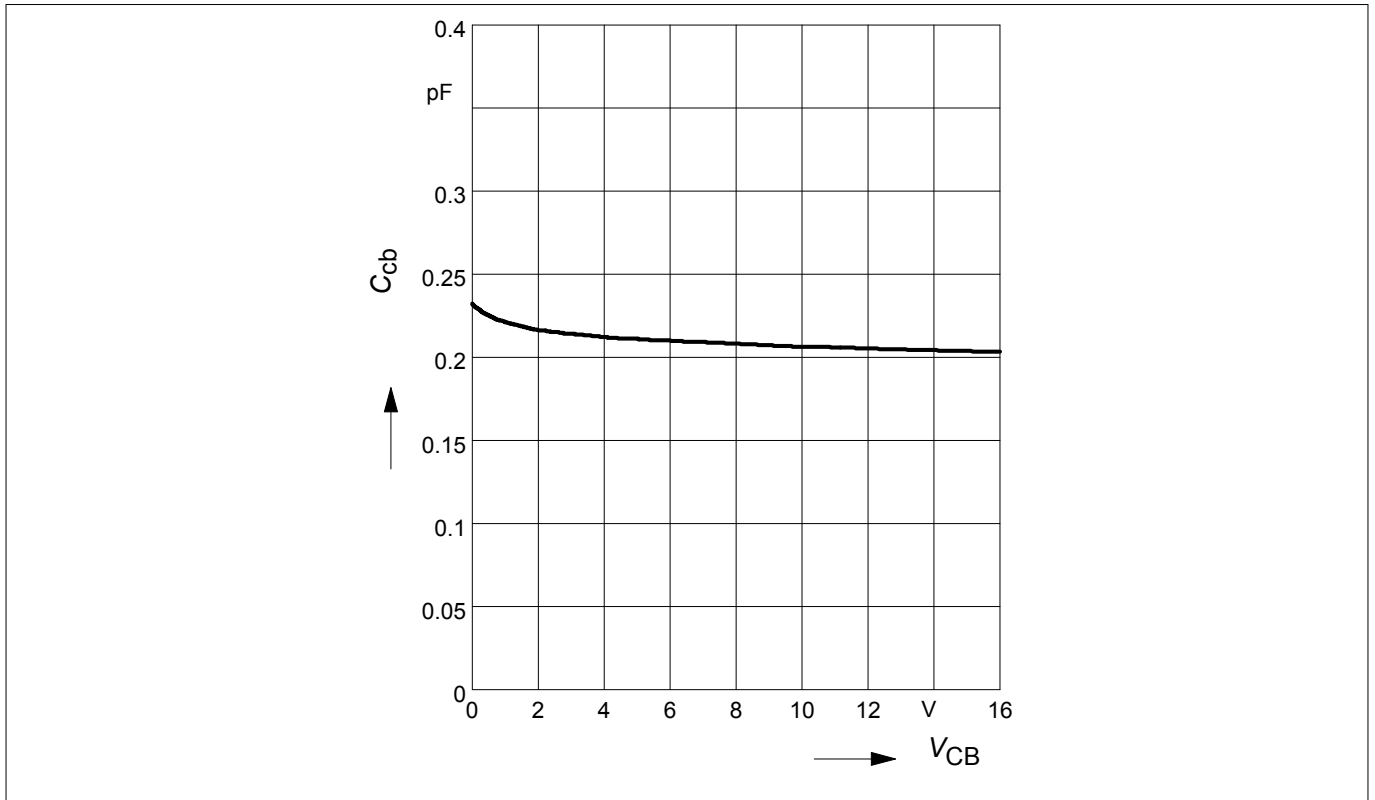
**Figure 4** 3rd order intercept point  $OIP_3 = f(I_C)$ ,  $Z_S = Z_L = 50 \Omega$ ,  $f = 1.9 \text{ GHz}$ ,  $V_{CE} = \text{parameter}$



**Electrical characteristics**

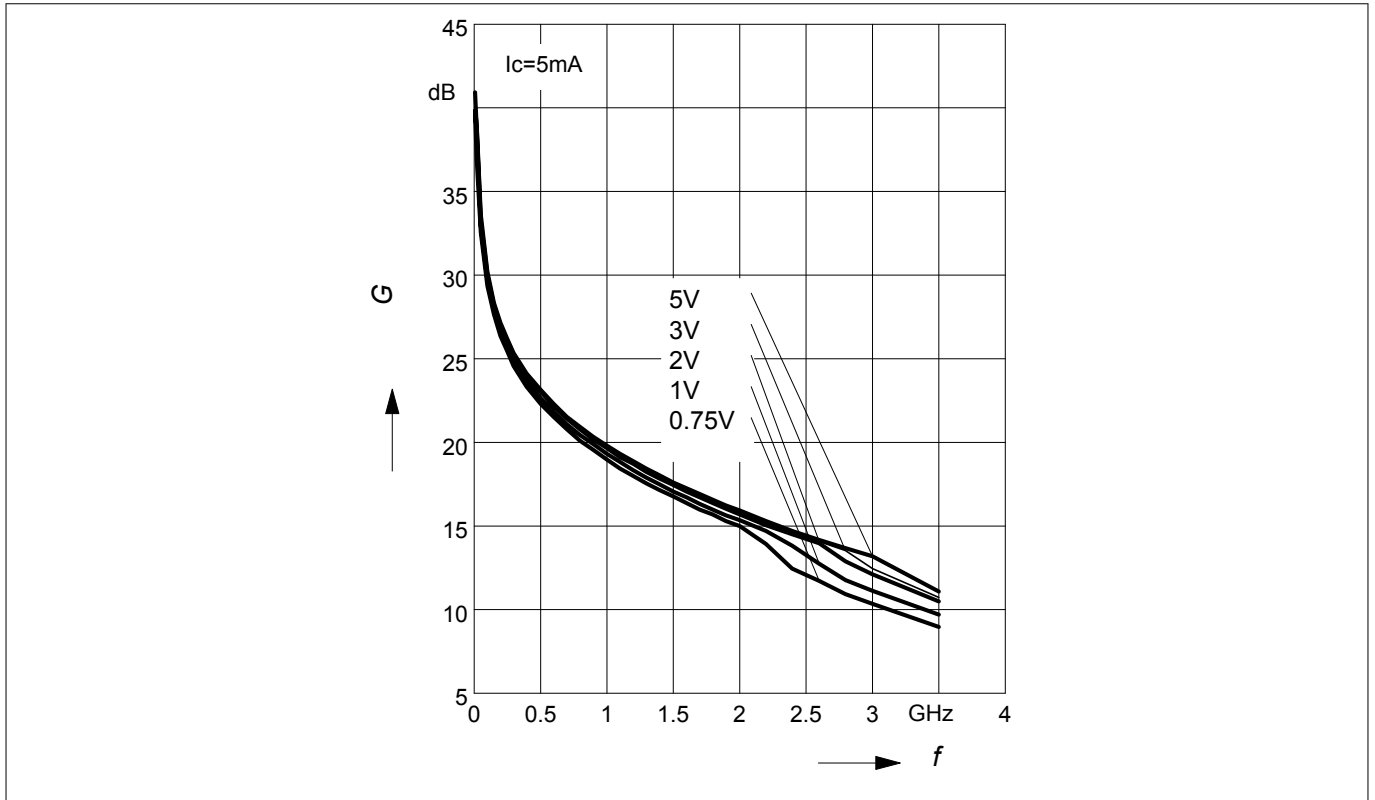


**Figure 5** 3rd order intercept point  $OIP_3 = f(I_C, V_{CE}), Z_S = Z_L = 50 \Omega, f = 100 \text{ MHz}$

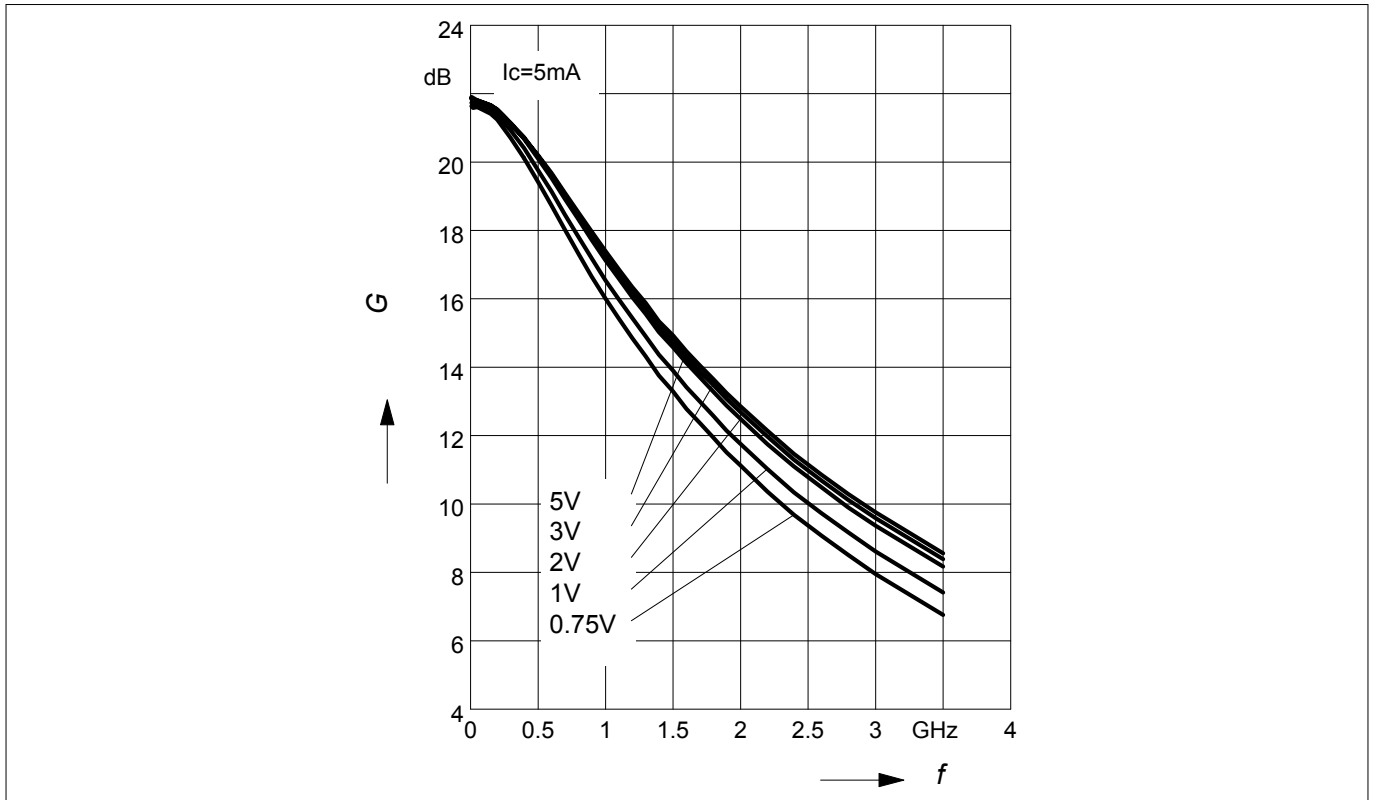


**Figure 6** Collector base capacitance  $C_{CB} = f(V_{CB}), f = 1 \text{ MHz}$

**Electrical characteristics**

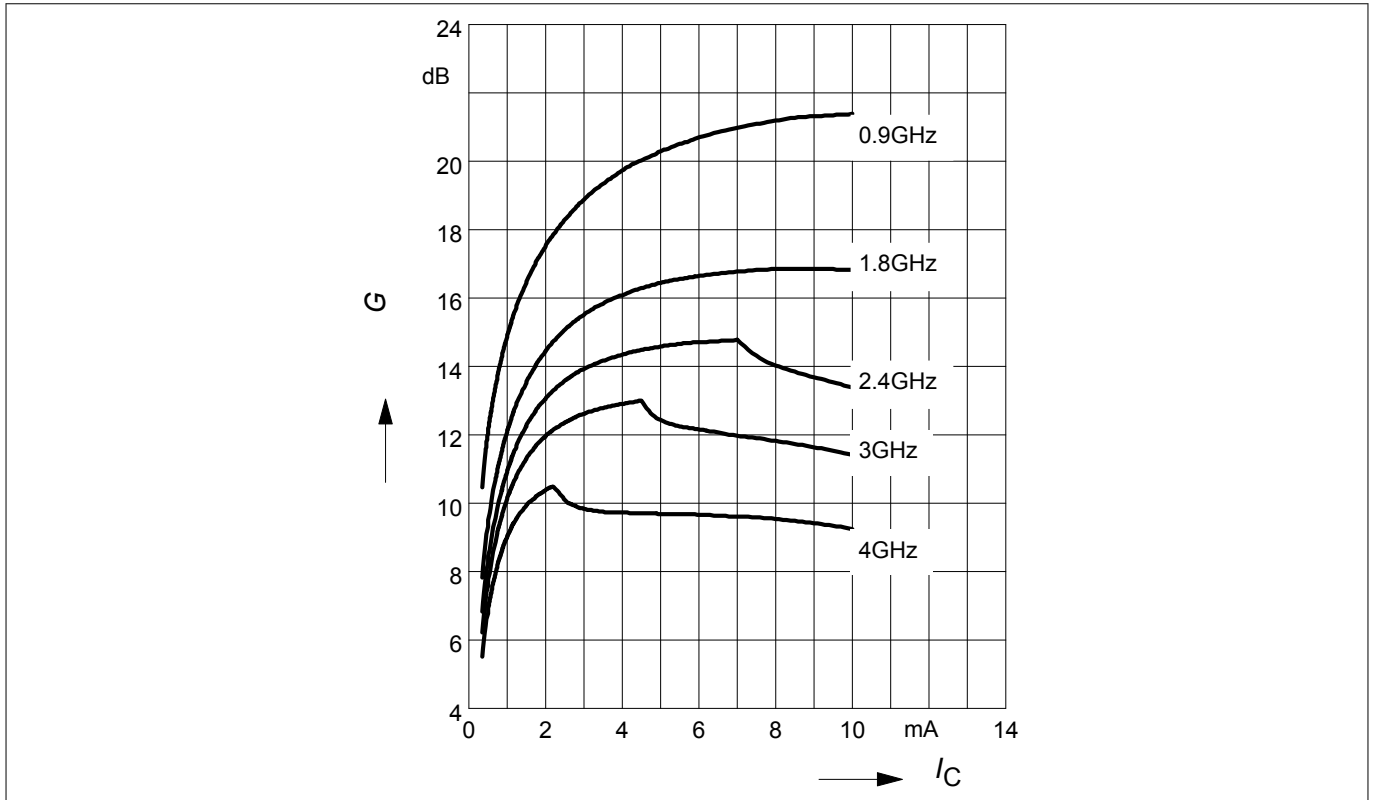


**Figure 7** Gain  $G_{ma}, G_{ms} = f(f), I_C = 5 \text{ mA}, V_{CE} = \text{parameter}$

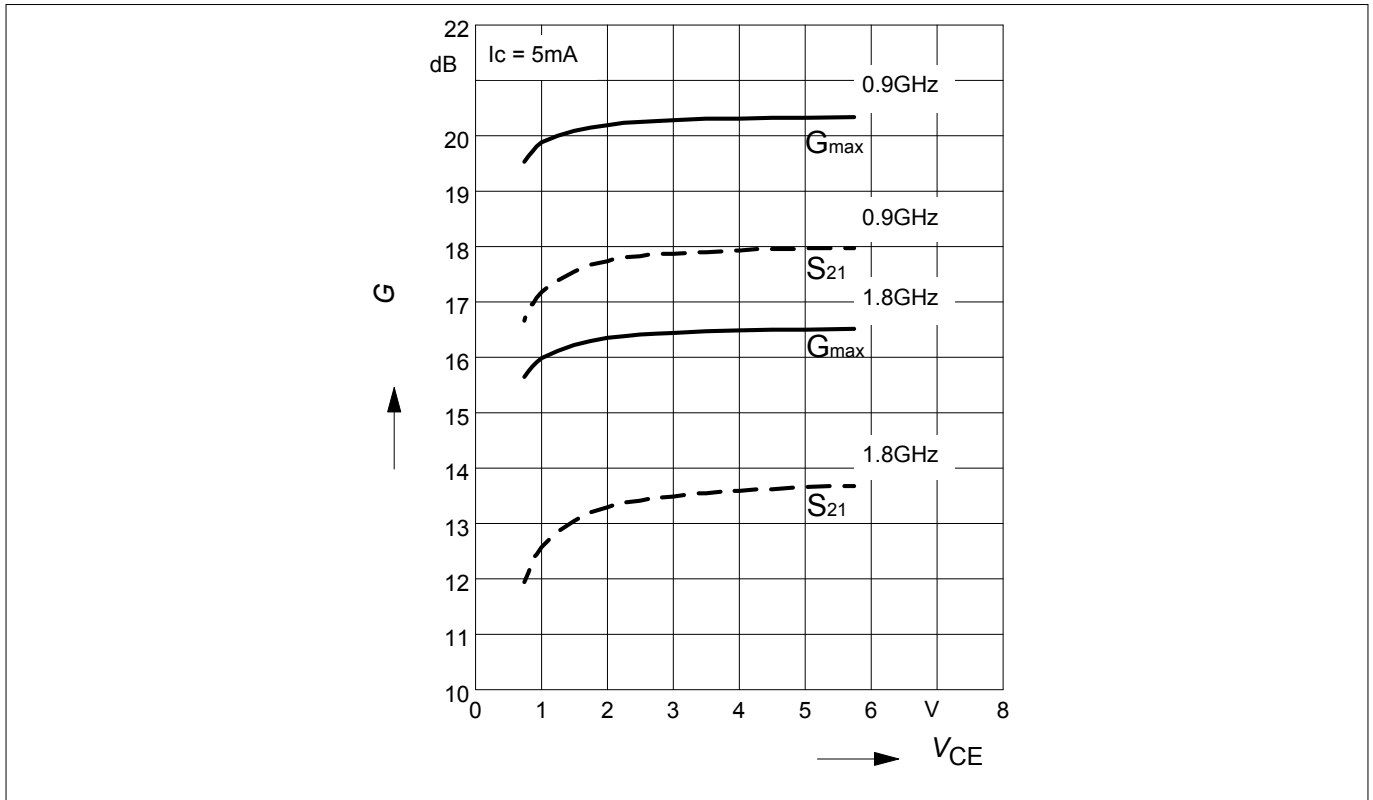


**Figure 8** Transducer gain  $IS_{21}^2 = f(f), I_C = 5 \text{ mA}, V_{CE} = \text{parameter}$

**Electrical characteristics**

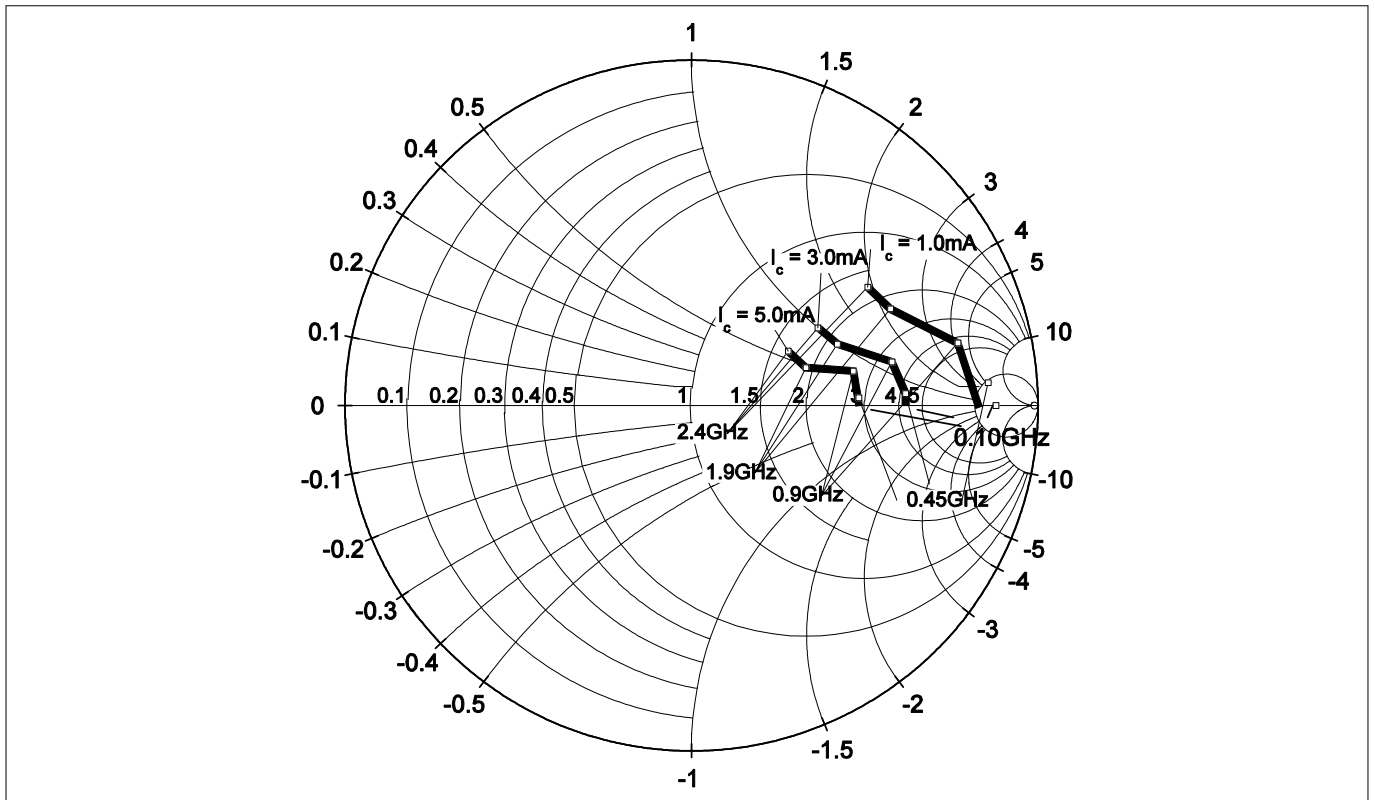


**Figure 9** Maximum power gain  $G_{max} = f(I_C)$ ,  $V_{CE} = 3\text{ V}$ ,  $f = \text{parameter}$

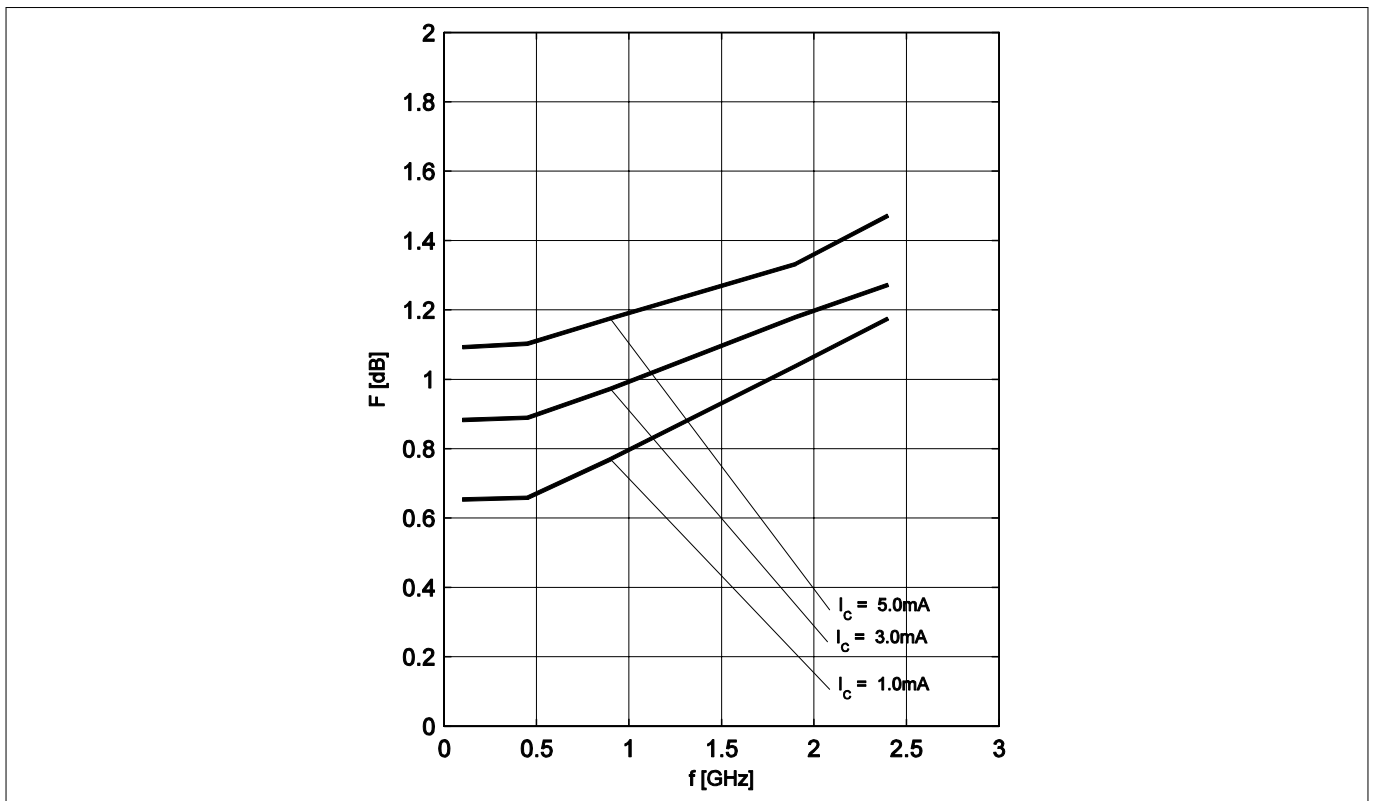


**Figure 10** Maximum power gain  $G_{max} = f(V_{CE})$ , transducer gain  $|S_{21}|^2 = f(V_{CE})$ ,  $I_C = 5\text{ mA}$ ,  $f = \text{parameter in GHz}$

**Electrical characteristics**

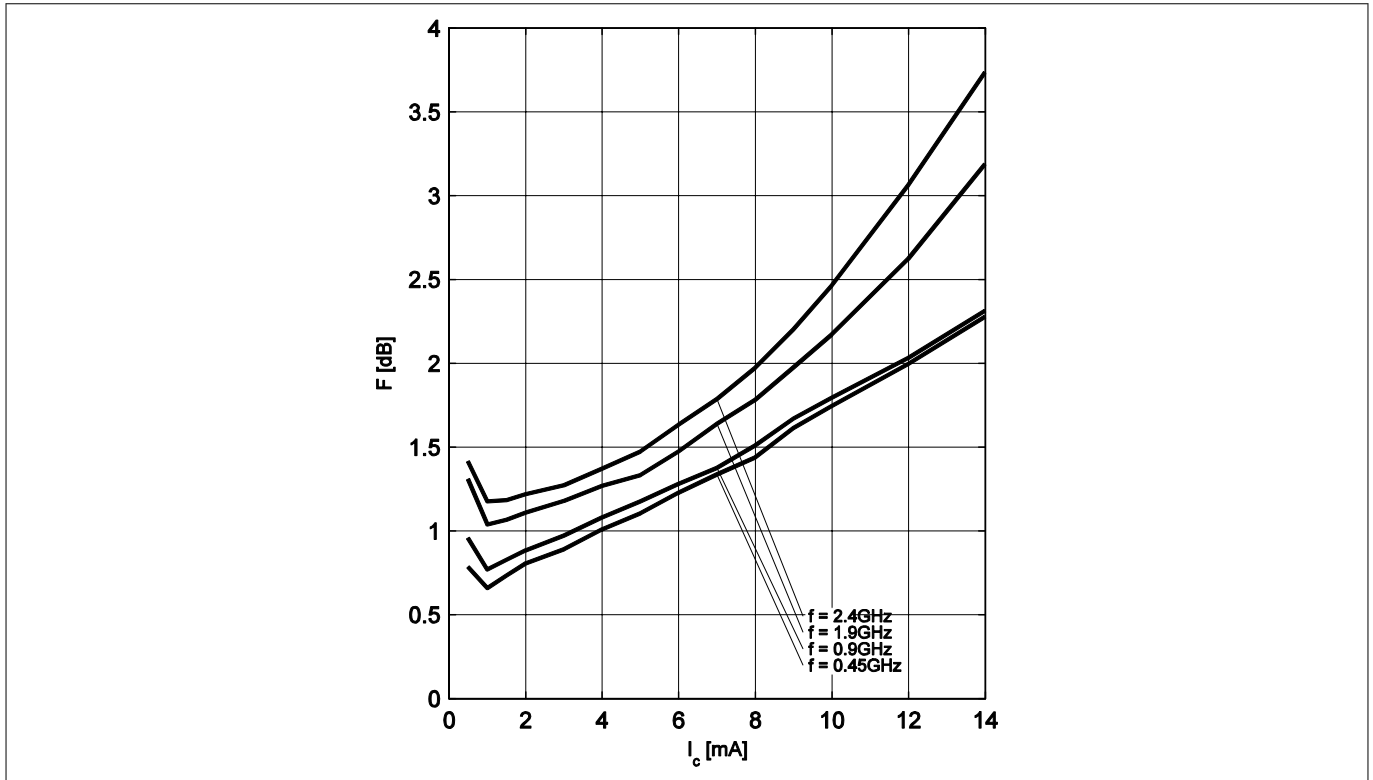


**Figure 11** Source impedance for minimum noise figure  $Z_{S,opt} = f(f)$ ,  $V_{CE} = 1.5\text{ V}$ ,  $I_C = \text{parameter}$

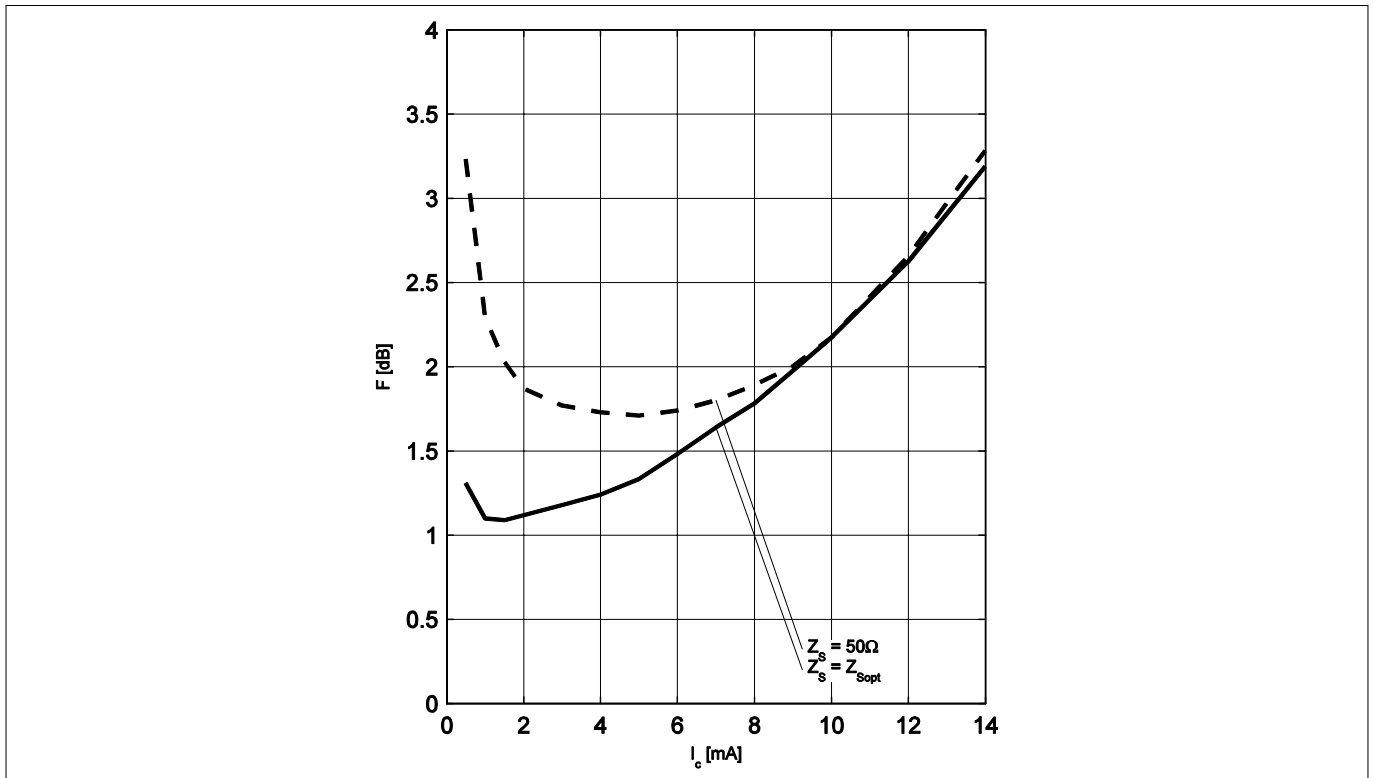


**Figure 12** Noise figure  $NF_{min} = f(f)$ ,  $V_{CE} = 1.5\text{ V}$ ,  $Z_S = Z_{S,opt}$ ,  $I_C = 1 / 3 / 5\text{ mA}$

**Electrical characteristics**



**Figure 13** Noise figure  $NF_{min} = f(I_C)$ ,  $V_{CE} = 1.5\text{ V}$ ,  $Z_S = Z_{S,opt}$ ,  $f = \text{parameter in GHz}$

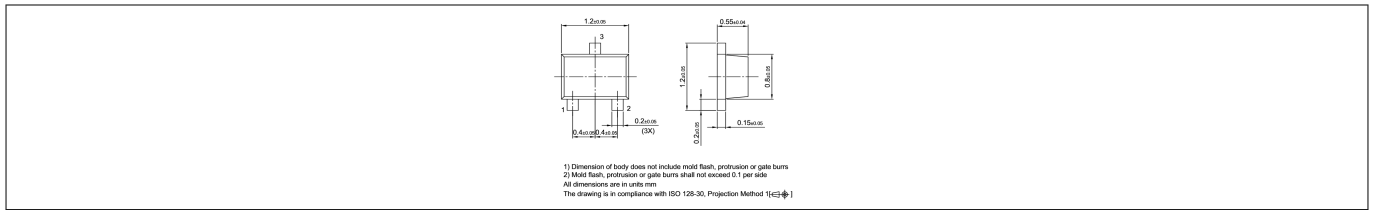


**Figure 14** Noise figure  $NF_{min} = f(I_C)$ ,  $Z_S = Z_{S,opt}$ ,  $NF_{50} = f(I_C)$ ,  $Z_S = 50\ \Omega$ ,  $V_{CE} = 3\text{ V}$ ,  $f = 1.9\text{ GHz}$

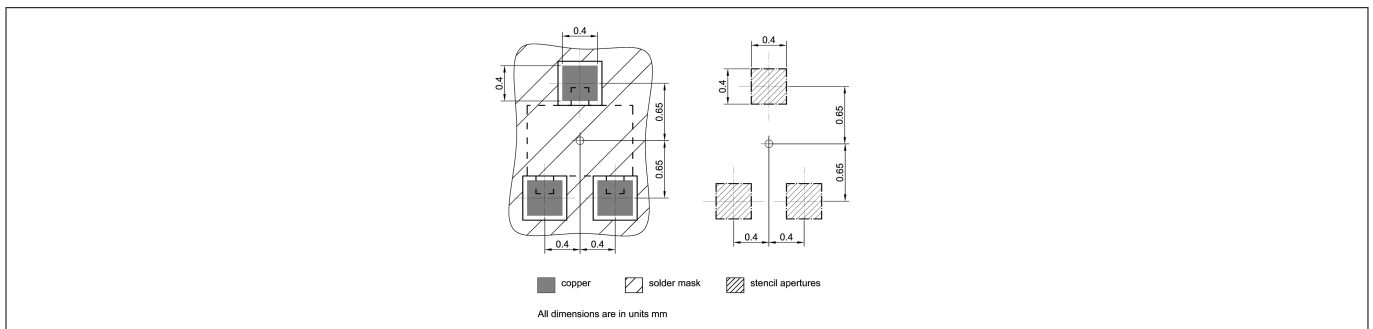
*Note:* The curves shown in this chapter have been generated using typical devices but shall not be considered as a guarantee that all devices have identical characteristic curves.  $T_A = 25\text{ }^\circ\text{C}$ .

**Package information TSFP-3-1**

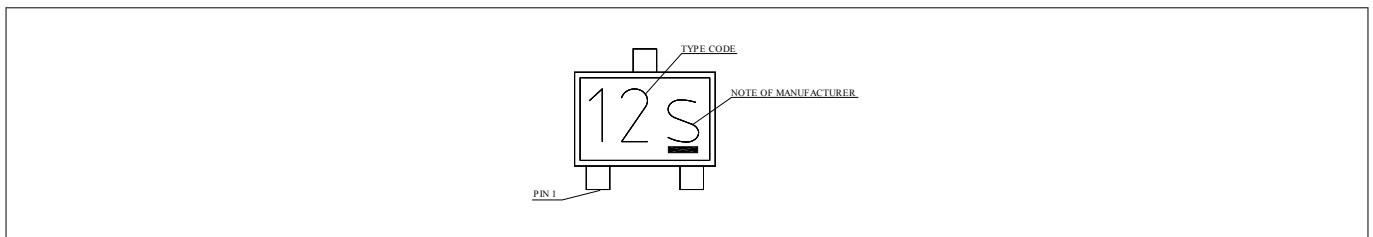
**4 Package information TSFP-3-1**



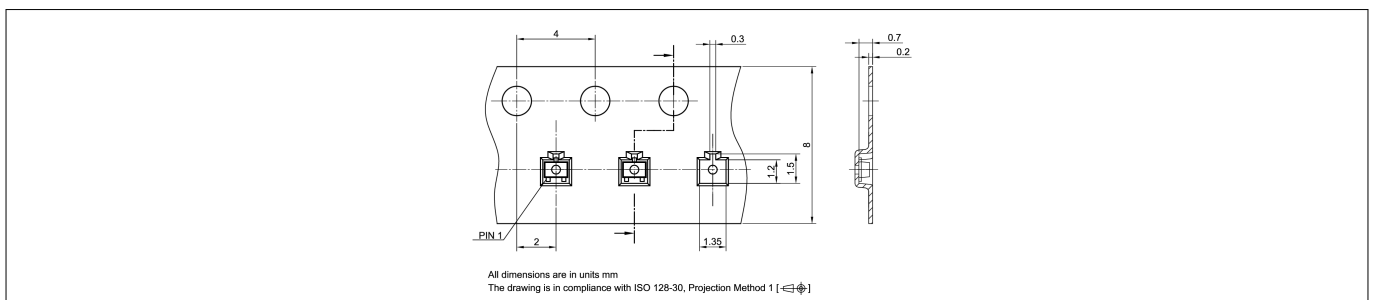
**Figure 15 Package outline**



**Figure 16 Foot print**



**Figure 17 Marking layout example**



**Figure 18 Tape information**

---

Revision history

## Revision history

Document version	Date of release	Description of changes
Revision 2.0	2019-01-25	New datasheet layout.

## Trademarks

All referenced product or service names and trademarks are the property of their respective owners.

**Edition 2019-01-25**

**Published by**  
**Infineon Technologies AG**  
**81726 Munich, Germany**

**© 2019 Infineon Technologies AG**  
**All Rights Reserved.**

**Do you have a question about any**  
**aspect of this document?**  
**Email: [erratum@infineon.com](mailto:erratum@infineon.com)**

**Document reference**  
**IFX-pky1525443005897**

## IMPORTANT NOTICE

The information given in this document shall in no event be regarded as a guarantee of conditions or characteristics ("Beschaffheitsgarantie").

With respect to any examples, hints or any typical values stated herein and/or any information regarding the application of the product, Infineon Technologies hereby disclaims any and all warranties and liabilities of any kind, including without limitation warranties of non-infringement of intellectual property rights of any third party.

In addition, any information given in this document is subject to customer's compliance with its obligations stated in this document and any applicable legal requirements, norms and standards concerning customer's products and any use of the product of Infineon Technologies in customer's applications.

The data contained in this document is exclusively intended for technically trained staff. It is the responsibility of customer's technical departments to evaluate the suitability of the product for the intended application and the completeness of the product information given in this document with respect to such application.

## WARNINGS

Due to technical requirements products may contain dangerous substances. For information on the types in question please contact your nearest Infineon Technologies office.

Except as otherwise explicitly approved by Infineon Technologies in a written document signed by authorized representatives of Infineon Technologies, Infineon Technologies' products may not be used in any applications where a failure of the product or any consequences of the use thereof can reasonably be expected to result in personal injury



单击下面可查看定价，库存，交付和生命周期等信息

[>>Infineon Technologies\(英飞凌\)](#)