

HEXFET® Power MOSFET

V_{DS}	-20	V
$R_{DS(on) \max}$ (@ $V_{GS} = -4.5V$)	8.2	mΩ
$R_{DS(on) \max}$ (@ $V_{GS} = -2.5V$)	13	
Q_g (typical)	87	nC
I_D (@ $T_A = 25^\circ C$)	-15	A

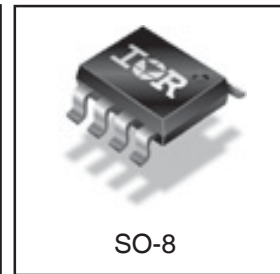
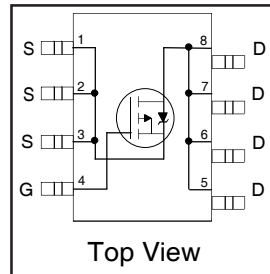

Features

Industry-standard pinout SO-8 Package
Compatible with Existing Surface Mount Techniques
RoHS Compliant, Halogen-Free
MSL1, Consumer qualification



Benefits

Multi-Vendor Compatibility
Easier Manufacturing
Environmentally Friendlier
Increased Reliability

Base Part Number	Package Type	Standard Pack		Orderable Part Number
		Form	Quantity	
IRF7425PbF	SO-8	Tube/Bulk	95	IRF7425PbF
		Tape and Reel	4000	IRF7425TRPbF

Absolute Maximum Ratings

	Parameter	Max.	Units
V_{DS}	Drain- Source Voltage	-20	V
I_D @ $T_A = 25^\circ C$	Continuous Drain Current, $V_{GS} @ -4.5V$	-15	A
I_D @ $T_A = 70^\circ C$	Continuous Drain Current, $V_{GS} @ -4.5V$	-12	
I_{DM}	Pulsed Drain Current ①	-60	
P_D @ $T_A = 25^\circ C$	Power Dissipation ③	2.5	W
P_D @ $T_A = 70^\circ C$	Power Dissipation ③	1.6	
	Linear Derating Factor	20	mW/°C
V_{GS}	Gate-to-Source Voltage	± 12	V
T_J, T_{STG}	Junction and Storage Temperature Range	-55 to + 150	°C

Thermal Resistance

	Parameter	Max.	Units
$R_{\theta JA}$	Maximum Junction-to-Ambient ③	50	°C/W

Electrical Characteristics @ T_J = 25°C (unless otherwise specified)

	Parameter	Min.	Typ.	Max.	Units	Conditions
V _{(BR)DSS}	Drain-to-Source Breakdown Voltage	-20	—	—	V	V _{GS} = 0V, I _D = -250μA
ΔV _{(BR)DSS} /ΔT _J	Breakdown Voltage Temp. Coefficient	—	0.010	—	V/°C	Reference to 25°C, I _D = -1mA
R _{DS(on)}	Static Drain-to-Source On-Resistance	—	—	8.2	mΩ	V _{GS} = -4.5V, I _D = -15A ②
		—	—	13		V _{GS} = -2.5V, I _D = -13A ②
V _{GS(th)}	Gate Threshold Voltage	-0.45	—	-1.2	V	V _{DS} = V _{GS} , I _D = -250μA
g _{fs}	Forward Transconductance	44	—	—	S	V _{DS} = -10V, I _D = -15A
I _{DSS}	Drain-to-Source Leakage Current	—	—	-1.0	μA	V _{DS} = -16V, V _{GS} = 0V
		—	—	-25		V _{DS} = -16V, V _{GS} = 0V, T _J = 70°C
I _{GSS}	Gate-to-Source Forward Leakage	—	—	-100	nA	V _{GS} = -12V
	Gate-to-Source Reverse Leakage	—	—	100		V _{GS} = 12V
Q _g	Total Gate Charge	—	87	130	nC	I _D = -15A
Q _{gs}	Gate-to-Source Charge	—	18	27		V _{DS} = -10V
Q _{gd}	Gate-to-Drain ("Miller") Charge	—	21	32		V _{GS} = -4.5V
t _{d(on)}	Turn-On Delay Time	—	13	—	ns	V _{DD} = -10V ②
t _r	Rise Time	—	20	—		I _D = -1.0A
t _{d(off)}	Turn-Off Delay Time	—	230	—		R _G = 6.0Ω
t _f	Fall Time	—	160	—		V _{GS} = -4.5V
C _{iss}	Input Capacitance	—	7980	—	pF	V _{GS} = 0V
C _{oss}	Output Capacitance	—	1480	—		V _{DS} = -15V
C _{rss}	Reverse Transfer Capacitance	—	980	—		f = 1.0kHz

Source-Drain Ratings and Characteristics

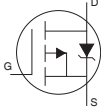
	Parameter	Min.	Typ.	Max.	Units	Conditions
I _S	Continuous Source Current (Body Diode)	—	—	-2.5	A	MOSFET symbol showing the integral reverse p-n junction diode. 
I _{SM}	Pulsed Source Current (Body Diode) ①	—	—	-60		
V _{SD}	Diode Forward Voltage	—	—	-1.2	V	T _J = 25°C, I _S = -2.5A, V _{GS} = 0V ②
t _{rr}	Reverse Recovery Time	—	120	180	ns	T _J = 25°C, I _F = -2.5A
Q _{rr}	Reverse Recovery Charge	—	160	240	nC	di/dt = -100A/μs ②

Notes:

- ① Repetitive rating; pulse width limited by max. junction temperature.
- ② Pulse width ≤ 400μs; duty cycle ≤ 2%.
- ③ Surface mounted on 1 in square Cu board, t ≤ 10sec.

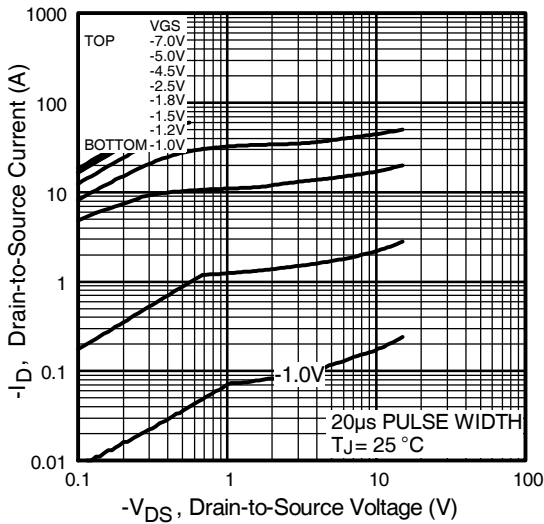
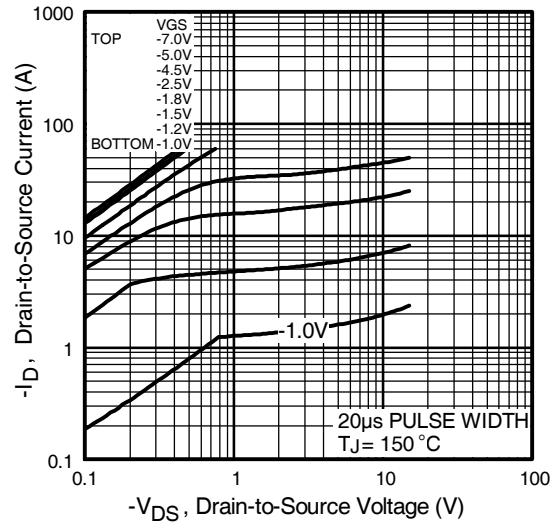
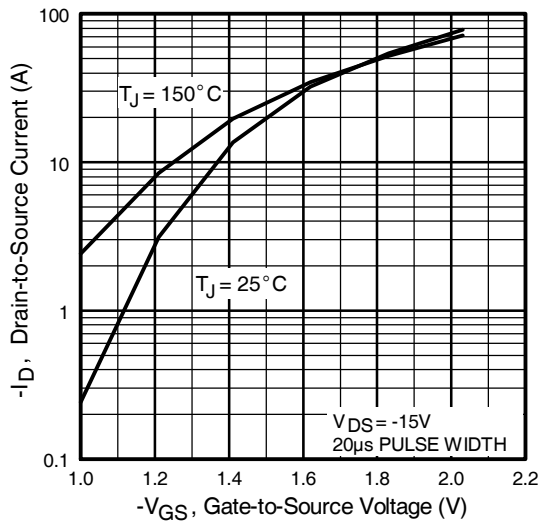
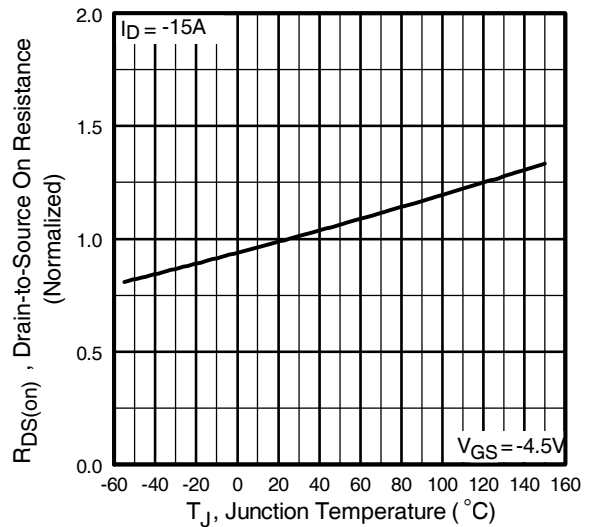
Fig 1. Typical Output Characteristics

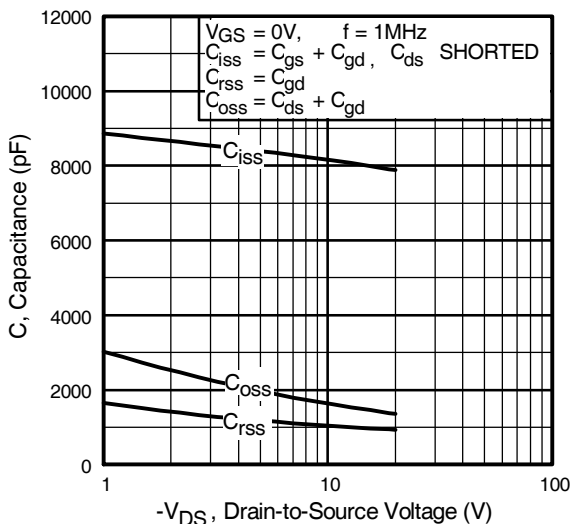
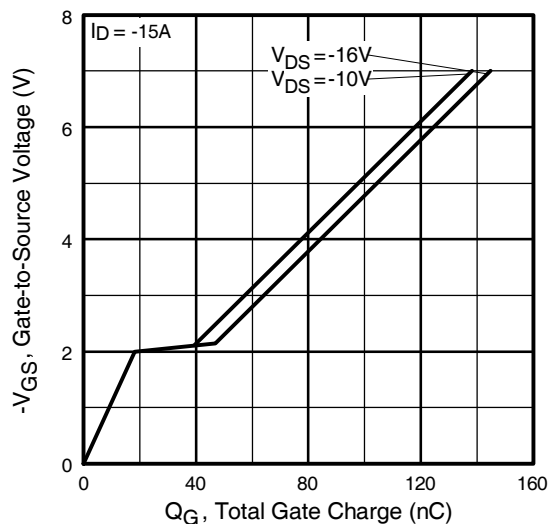
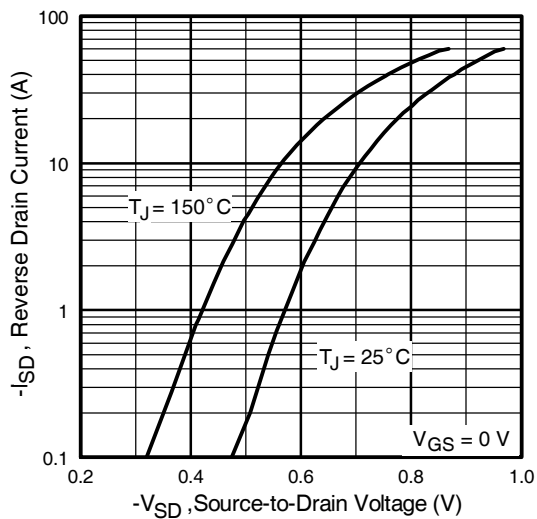
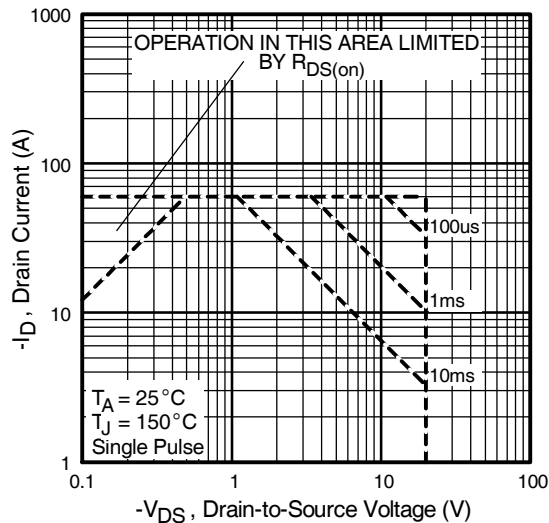
Fig 2. Typical Output Characteristics

Fig 3. Typical Transfer Characteristics

Fig 4. Normalized On-Resistance Vs. Temperature

Fig 5. Typical Capacitance Vs. Drain-to-Source Voltage

Fig 6. Typical Gate Charge Vs. Gate-to-Source Voltage

Fig 7. Typical Source-Drain Diode Forward Voltage

Fig 8. Maximum Safe Operating Area

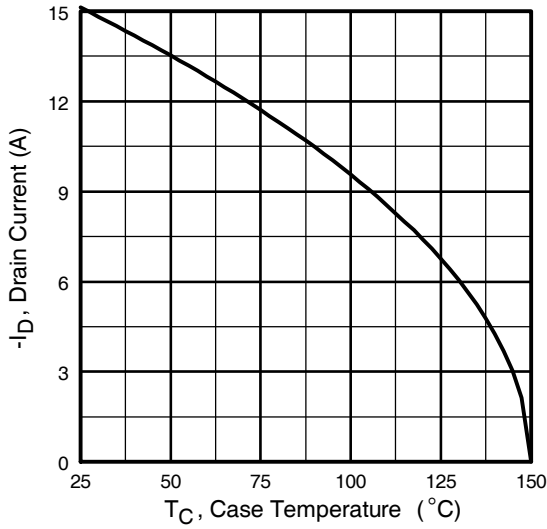

Fig 9. Maximum Drain Current Vs. Case Temperature

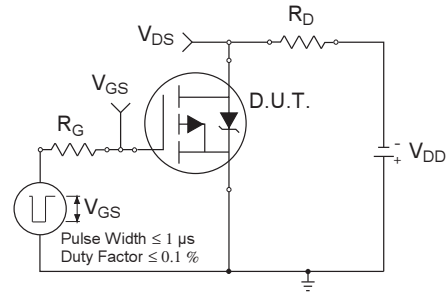

Fig 10a. Switching Time Test Circuit

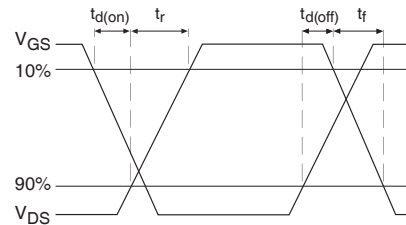

Fig 10b. Switching Time Waveforms

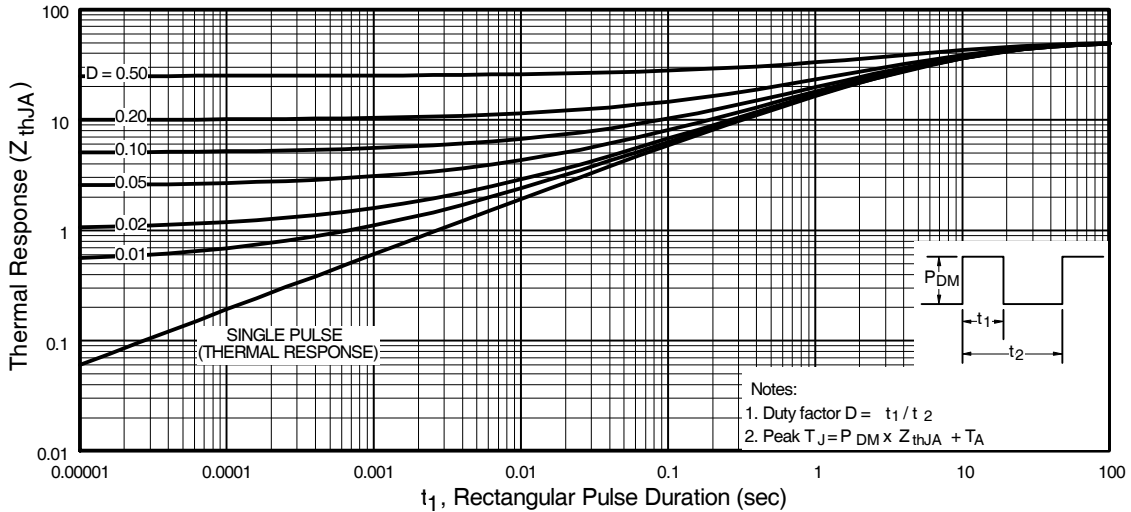

Fig 11. Maximum Effective Transient Thermal Impedance, Junction-to-Ambient

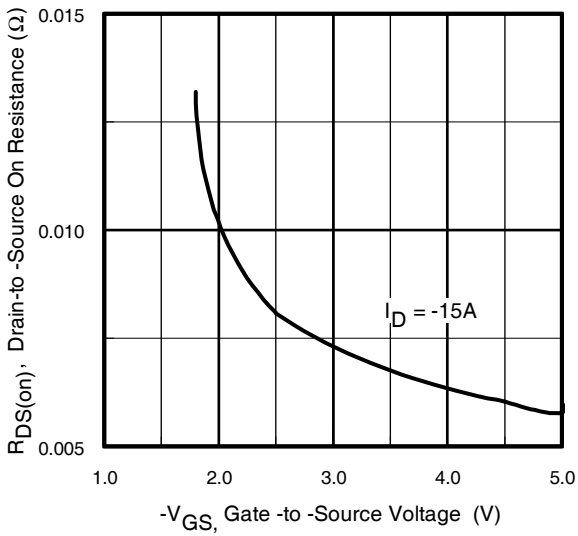

Fig 12. Typical On-Resistance Vs. Gate Voltage

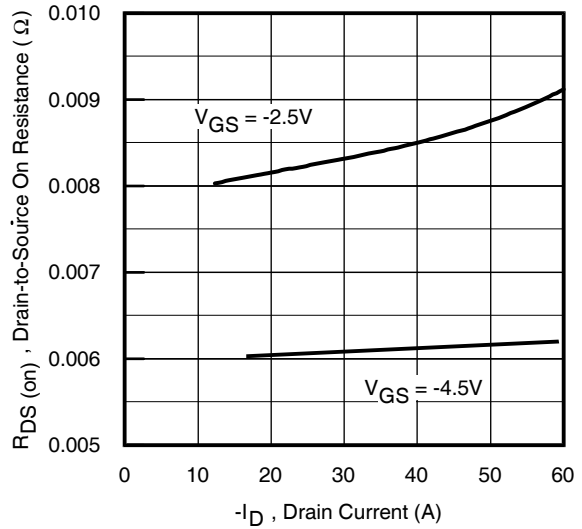

Fig 13. Typical On-Resistance Vs. Drain Current

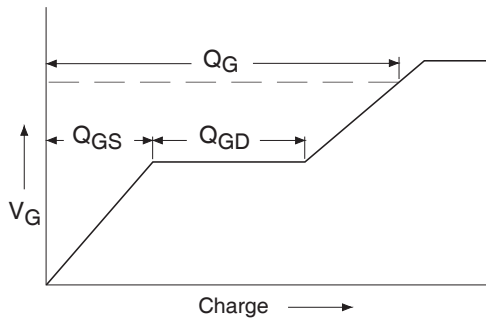

Fig 14a. Basic Gate Charge Waveform

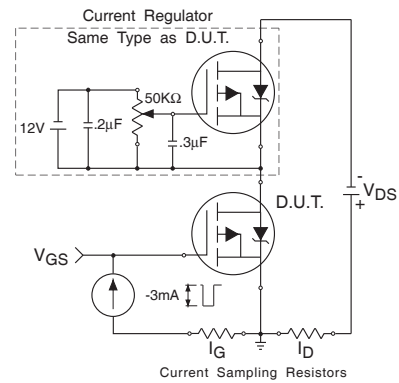

Fig 14b. Gate Charge Test Circuit

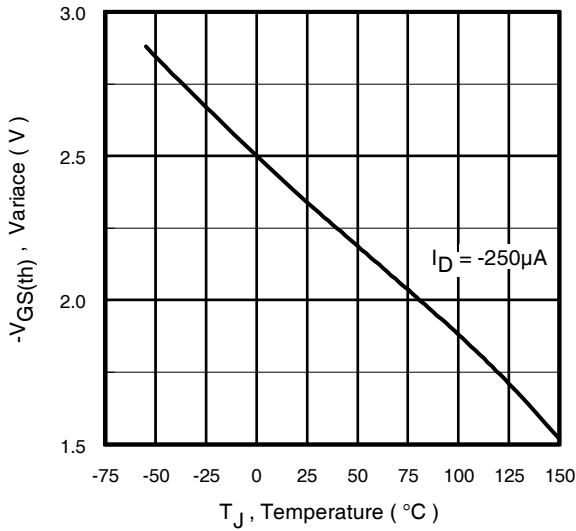

Fig 15. Typical V_{GS(th)} Variance Vs. Junction Temperature

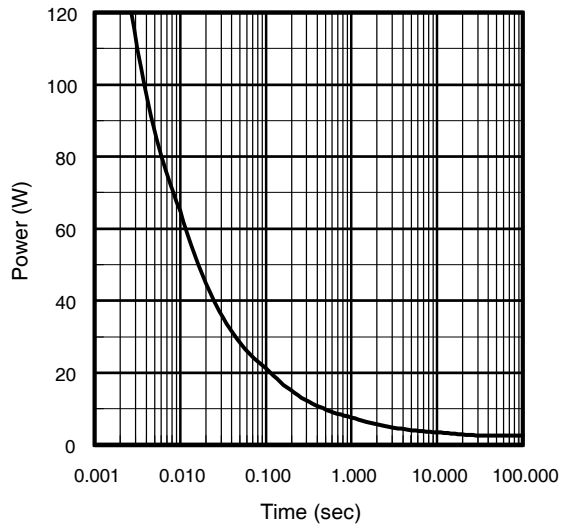
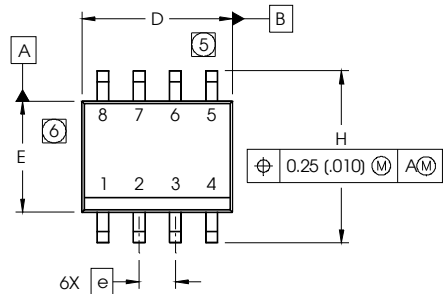

Fig 16. Typical Power Vs. Time

SO-8 Package Outline

Dimensions are shown in millimeters (inches)



DIM	INCHES		MILLIMETERS	
	MIN	MAX	MIN	MAX
A	.0532	.0688	1.35	1.75
A1	.0040	.0098	0.10	0.25
b	.013	.020	0.33	0.51
c	.0075	.0098	0.19	0.25
D	.189	.1968	4.80	5.00
E	.1497	.1574	3.80	4.00
e	.050 BASIC		1.27 BASIC	
e1	.025 BASIC		0.635 BASIC	
H	.2284	.2440	5.80	6.20
K	.0099	.0196	0.25	0.50
L	.016	.050	0.40	1.27
y	0°	8°	0°	8°

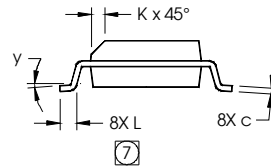
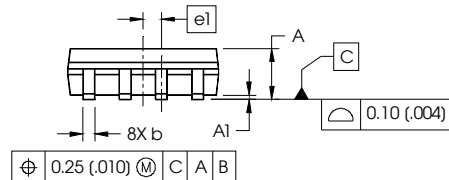

NOTES:

1. DIMENSIONING & TOLERANCING PER ASME Y14.5M-1994.
2. CONTROLLING DIMENSION: MILLIMETER
3. DIMENSIONS ARE SHOWN IN MILLIMETERS (INCHES).
4. OUTLINE CONFORMS TO JEDEC OUTLINE MS-012AA.
- ⑤ DIMENSION DOES NOT INCLUDE MOLD PROTRUSIONS. MOLD PROTRUSIONS NOT TO EXCEED 0.15 (.006).
- ⑥ DIMENSION DOES NOT INCLUDE MOLD PROTRUSIONS. MOLD PROTRUSIONS NOT TO EXCEED 0.25 (.010).
- ⑦ DIMENSION IS THE LENGTH OF LEAD FOR SOLDERING TO A SUBSTRATE.

FOOTPRINT

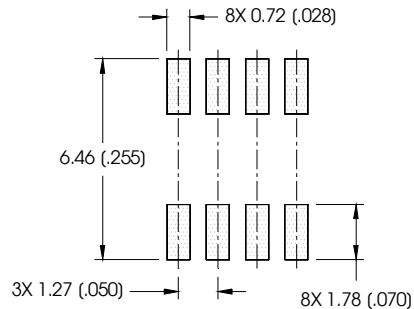

SO-8 Part Marking

EXAMPLE: THIS IS AN IRF7101 (MOSFET)

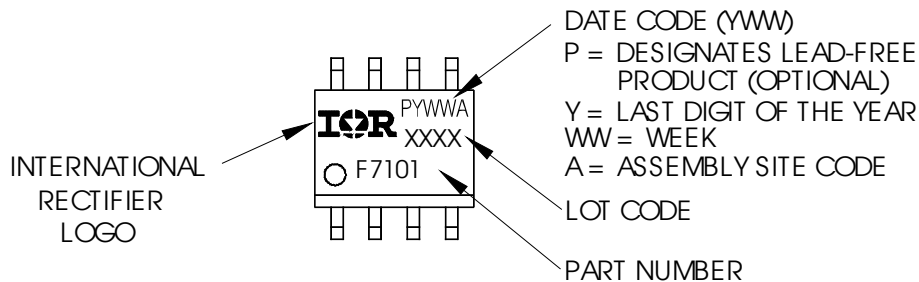

Note: For the most current drawing please refer to IR website at: <http://www.irf.com/package/>

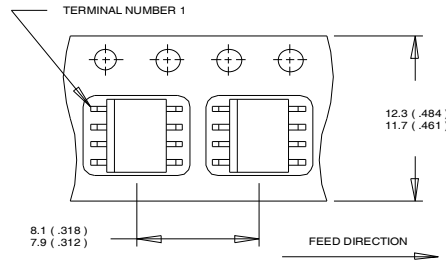
SO-8 Tape and Reel (Dimensions are shown in millimeters (inches))

- NOTES:
1. CONTROLLING DIMENSION : MILLIMETER.
 2. ALL DIMENSIONS ARE SHOWN IN MILLIMETERS(INCHES).
 3. OUTLINE CONFORMS TO EIA-481 & EIA-541.

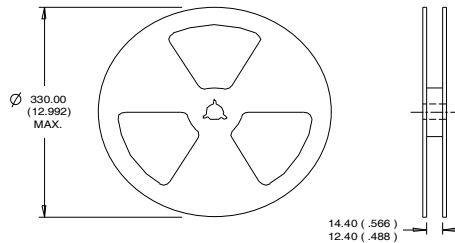

- NOTES :
1. CONTROLLING DIMENSION : MILLIMETER.
 2. OUTLINE CONFORMS TO EIA-481 & EIA-541.

Note: For the most current drawing please refer to IR website at: <http://www.irf.com/package/>

Qualification information[†]

Qualification level	Consumer (per JEDEC JESD47F ^{††} guidelines)	
Moisture Sensitivity Level	SO-8	M6L1 (per JEDEC J-STD-020D ^{††})
RoHS compliant	Yes	

[†] Qualification standards can be found at International Rectifier's web site: <http://www.irf.com/product-info/reliability>

^{††} Applicable version of JEDEC standard at the time of product release

Revision History

Date	Comments
10/29/2013	<ul style="list-style-type: none"> • Added ordering information on page 1. • Updated datasheet with new IR corporate template.

单击下面可查看定价，库存，交付和生命周期等信息

[>>Infineon Technologies\(英飞凌\)](#)