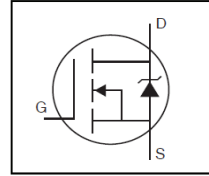


- Surface Mount
- Advanced Process Technology
- Ultra Low On-Resistance
- Dynamic dv/dt Rating
- Fast Switching
- Fully Avalanche Rated
- Lead-Free

HEXFET® Power MOSFET



$V_{DSS}$	<b>55V</b>
$R_{DS(on)}$	<b>0.045Ω</b>
$I_D$	<b>3.7A</b>



SOT-223

<b>G</b>	<b>D</b>	<b>S</b>
Gate	Drain	Source

**Description**

Fifth Generation HEXFETs from International Rectifier utilize advanced processing techniques to achieve extremely low on-resistance per silicon area. This benefit, combined with the fast switching speed and ruggedized device design that HEXFET Power MOSFETs are well known for, provides the designer with an extremely efficient and reliable device for use in a wide variety of applications.

The SOT-223 package is designed for surface-mount using vapor phase, infra red, or wave soldering techniques. Its unique package design allows for easy automatic pick-and-place as with other SOT or SOIC packages but has the added advantage of improved thermal performance due to an enlarged tab for heat sinking. Power dissipation of 1.0W is possible in a typical surface mount application.

Base Part Number	Package Type	Standard Pack		Orderable Part Number
		Form	Quantity	
IRFL4105PbF	SOT-223	Tape and Reel	2500	IRFL4105PbF

**Absolute Maximum Ratings**

Symbol	Parameter	Max.	Units
$I_D @ T_A = 25^\circ\text{C}$	Continuous Drain Current, $V_{GS} @ 10\text{V}$ ⑥	5.2	A
$I_D @ T_A = 25^\circ\text{C}$	Continuous Drain Current, $V_{GS} @ 10\text{V}$ ⑤	3.7	
$I_D @ T_A = 70^\circ\text{C}$	Continuous Drain Current, $V_{GS} @ 10\text{V}$ ⑤	3.0	
$I_{DM}$	Pulsed Drain Current ①	30	
$P_D @ T_A = 25^\circ\text{C}$	Maximum Power Dissipation (PCB Mount) ⑥	2.1	W
$P_D @ T_A = 25^\circ\text{C}$	Maximum Power Dissipation (PCB Mount) ⑤	1.0	
	Linear Derating Factor (PCB Mount) ⑤	8.3	mW/°C
$V_{GS}$	Gate-to-Source Voltage	± 20	V
$E_{AS}$	Single Pulse Avalanche Energy (Thermally Limited) ②	110	mJ
$I_{AR}$	Avalanche Current ①	3.7	A
$E_{AR}$	Repetitive Avalanche Energy ①	0.10	mJ
dv/dt	Peak Diode Recovery dv/dt ③	5.0	V/ns
$T_J$ $T_{STG}$	Operating Junction and Storage Temperature Range	-55 to + 150	°C

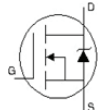
**Thermal Resistance**

Symbol	Parameter	Typ.	Max.	Units
$R_{\theta JA}$	Junction-to-Ambient (PCB Mount, steady state) ⑤	90	120	°C/W
$R_{\theta JA}$	Junction-to-Ambient (PCB Mount, steady state) ⑥	50	60	

**Electrical Characteristics @ T<sub>J</sub> = 25°C (unless otherwise specified)**

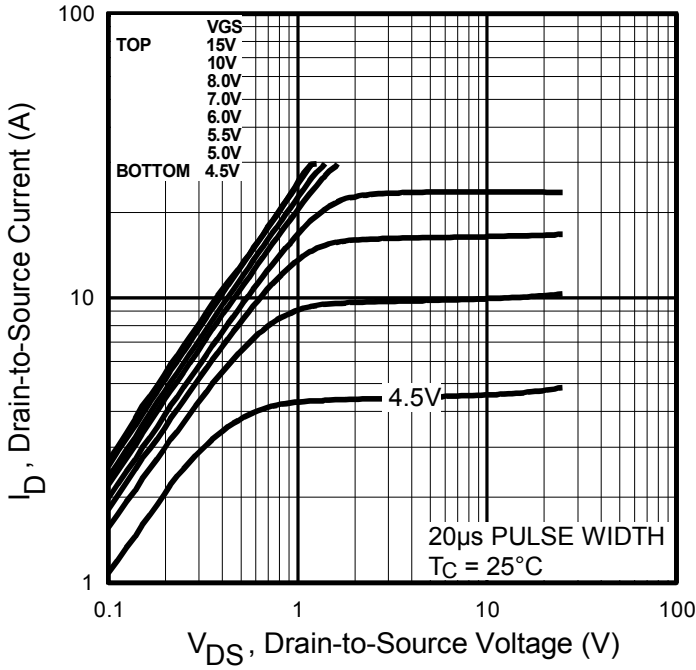
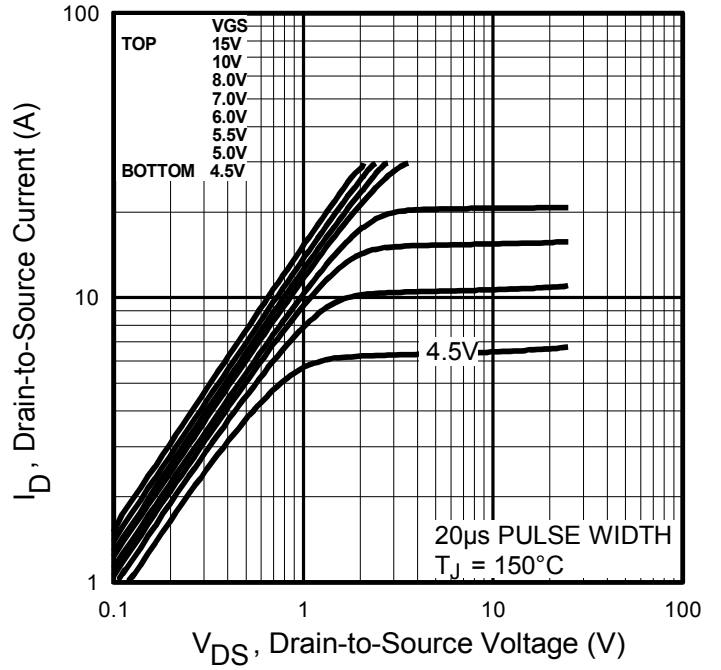
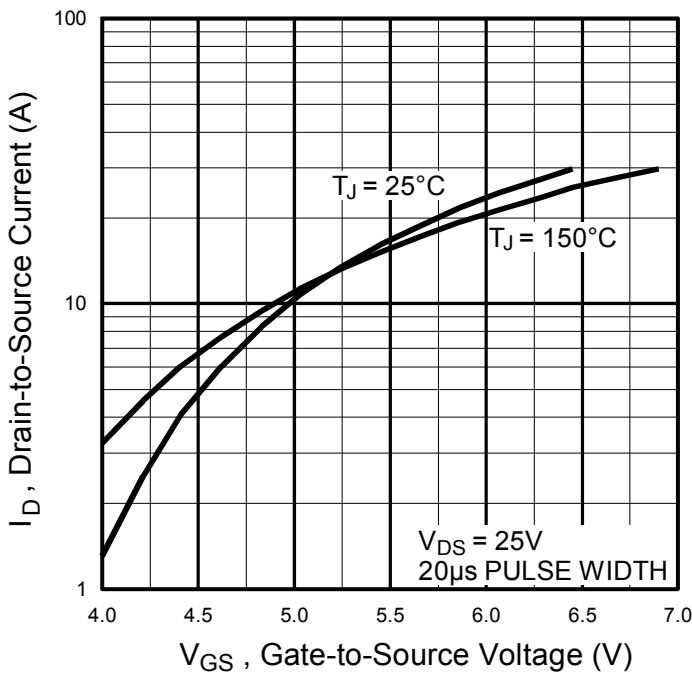
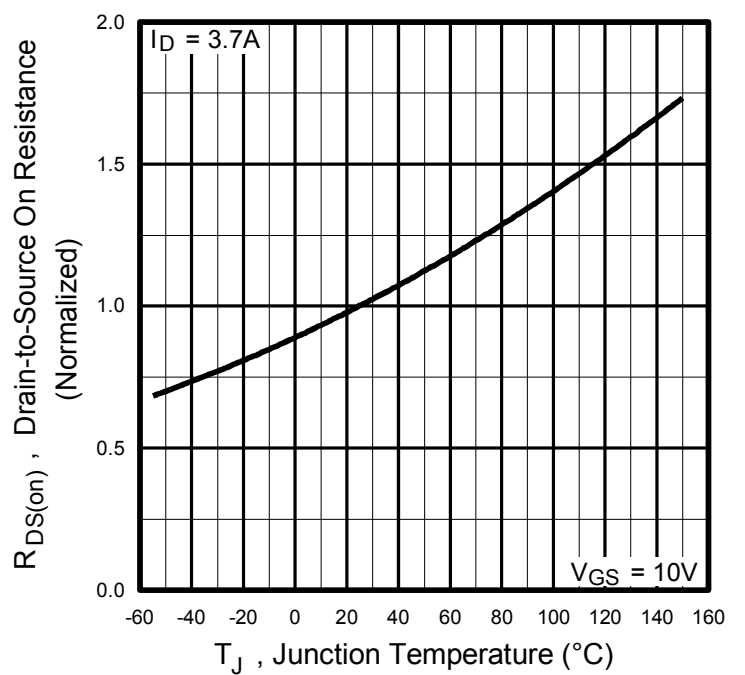
	Parameter	Min.	Typ.	Max.	Units	Conditions
V <sub>(BR)DSS</sub>	Drain-to-Source Breakdown Voltage	55	—	—	V	V <sub>GS</sub> = 0V, I <sub>D</sub> = 250μA
ΔV <sub>(BR)DSS/ΔT<sub>J</sub></sub>	Breakdown Voltage Temp. Coefficient	—	0.058	—	V/°C	Reference to 25°C, I <sub>D</sub> = 1mA
R <sub>DS(on)</sub>	Static Drain-to-Source On-Resistance	—	—	0.045	Ω	V <sub>GS</sub> = 10V, I <sub>D</sub> = 3.7A ④
V <sub>GS(th)</sub>	Gate Threshold Voltage	2.0	—	4.0	V	V <sub>DS</sub> = V <sub>GS</sub> , I <sub>D</sub> = 250μA
g <sub>fs</sub>	Forward Trans conductance	3.8	—	—	S	V <sub>DS</sub> = 25V, I <sub>D</sub> = 1.9A
I <sub>DSS</sub>	Drain-to-Source Leakage Current	—	—	25	μA	V <sub>DS</sub> = 55 V, V <sub>GS</sub> = 0V
		—	—	250		V <sub>DS</sub> = 44V, V <sub>GS</sub> = 0V, T <sub>J</sub> = 150°C
I <sub>GSS</sub>	Gate-to-Source Forward Leakage	—	—	100	nA	V <sub>GS</sub> = 20V
	Gate-to-Source Reverse Leakage	—	—	-100		V <sub>GS</sub> = -20V
Q <sub>g</sub>	Total Gate Charge	—	23	35	nC	I <sub>D</sub> = 3.7A
Q <sub>gs</sub>	Gate-to-Source Charge	—	3.4	5.1		V <sub>DS</sub> = 44V
Q <sub>gd</sub>	Gate-to-Drain Charge	—	9.8	15		V <sub>GS</sub> = 10V, See Fig. 6 and 13 ④
t <sub>d(on)</sub>	Turn-On Delay Time	—	7.1	—	ns	V <sub>DD</sub> = 28V
t <sub>r</sub>	Rise Time	—	12	—		I <sub>D</sub> = 3.7A
t <sub>d(off)</sub>	Turn-Off Delay Time	—	19	—		R <sub>G</sub> = 6.0Ω
t <sub>f</sub>	Fall Time	—	12	—		R <sub>D</sub> = 7.5Ω, See Fig. 10 ④
C <sub>iss</sub>	Input Capacitance	—	660	—	pF	V <sub>GS</sub> = 0V
C <sub>oss</sub>	Output Capacitance	—	230	—		V <sub>DS</sub> = 25V
C <sub>rss</sub>	Reverse Transfer Capacitance	—	99	—		f = 1.0MHz, See Fig. 5

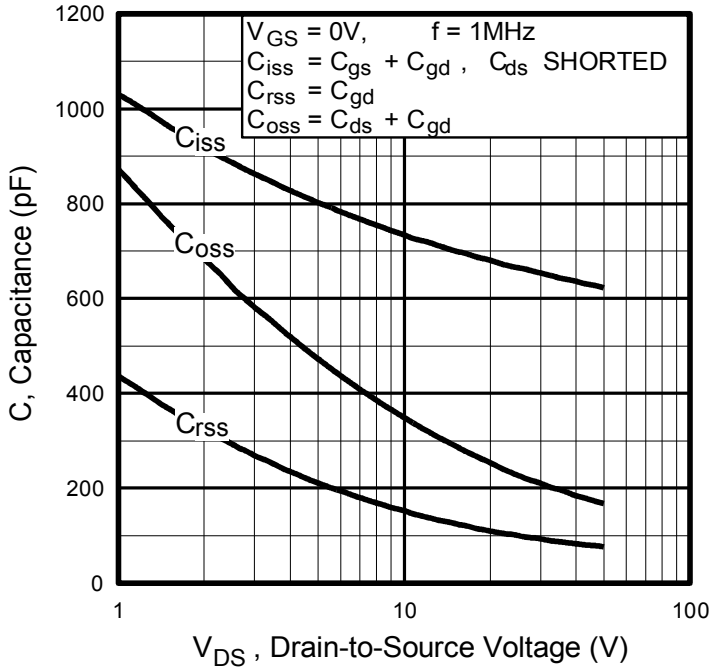
**Source-Drain Ratings and Characteristics**

	Parameter	Min.	Typ.	Max.	Units	Conditions
I <sub>S</sub>	Continuous Source Current (Body Diode)	—	—	1.3	A	MOSFET symbol showing the integral reverse p-n junction diode. 
I <sub>SM</sub>	Pulsed Source Current (Body Diode) ①	—	—	30		
V <sub>SD</sub>	Diode Forward Voltage	—	—	1.3	V	T <sub>J</sub> = 25°C, I <sub>S</sub> = 3.7A, V <sub>GS</sub> = 0V ④
t <sub>rr</sub>	Reverse Recovery Time	—	55	82	ns	T <sub>J</sub> = 25°C, I <sub>F</sub> = 3.7A
Q <sub>rr</sub>	Reverse Recovery Charge	—	120	170	nC	di/dt = 100A/μs ④

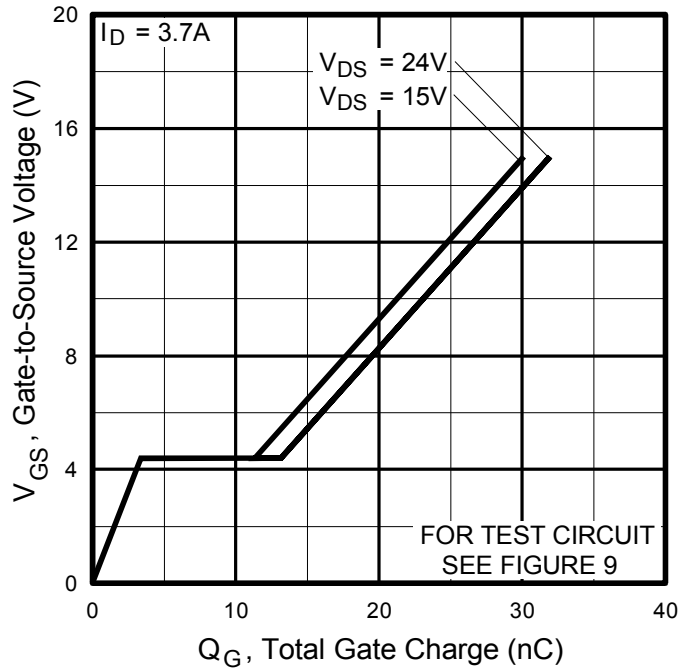
**Notes:**

- ① Repetitive rating; pulse width limited by max. junction temperature. (See fig. 11)
- ② starting T<sub>J</sub> = 25°C, L = 16mH, R<sub>G</sub> = 25Ω, I<sub>AS</sub> = 3.7A (See fig. 12)
- ③ I<sub>SD</sub> ≤ 3.7A, di/dt ≤ 110A/μs, V<sub>DD</sub> ≤ V<sub>(BR)DSS</sub>, T<sub>J</sub> ≤ 150°C.
- ④ Pulse width ≤ 300μs; duty cycle ≤ 2%.

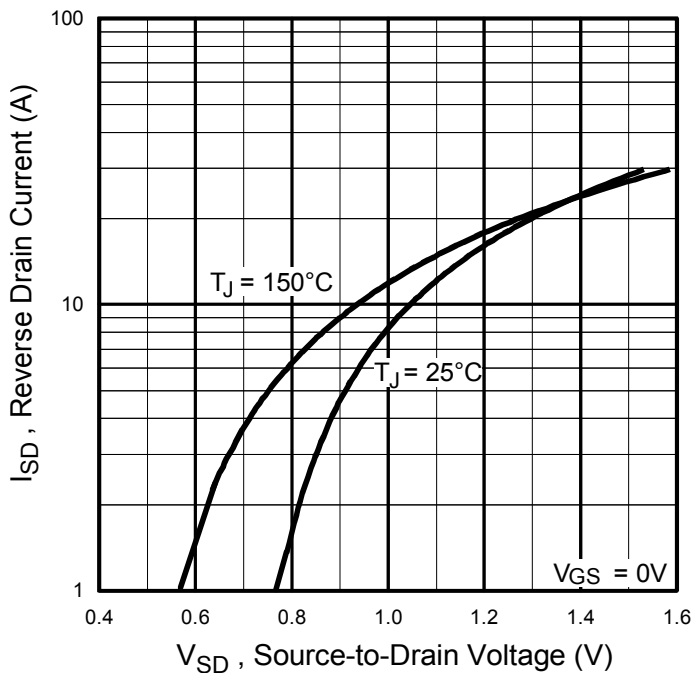

**Fig. 1** Typical Output Characteristics

**Fig. 2** Typical Output Characteristics

**Fig. 3** Typical Transfer Characteristics

**Fig. 4** Normalized On-Resistance vs. Temperature



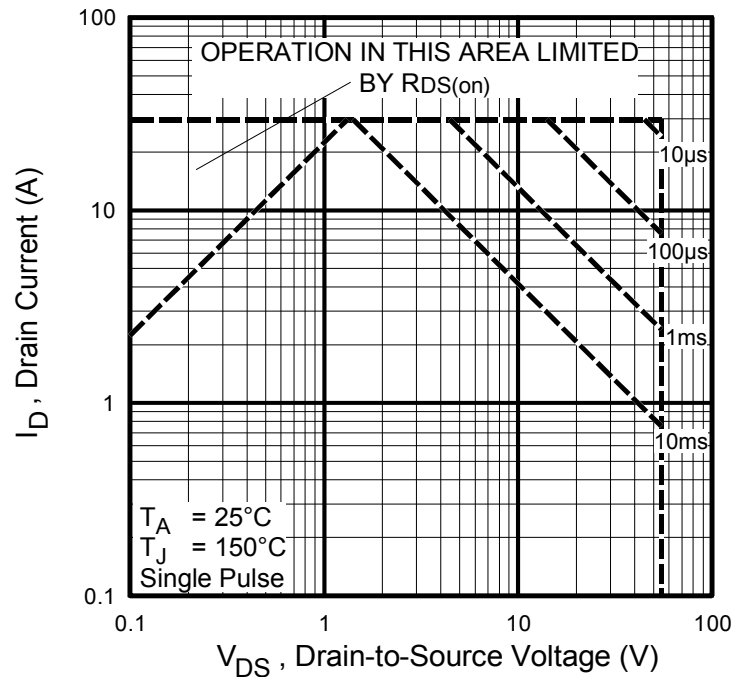
**Fig 5.** Typical Capacitance vs. Drain-to-Source Voltage



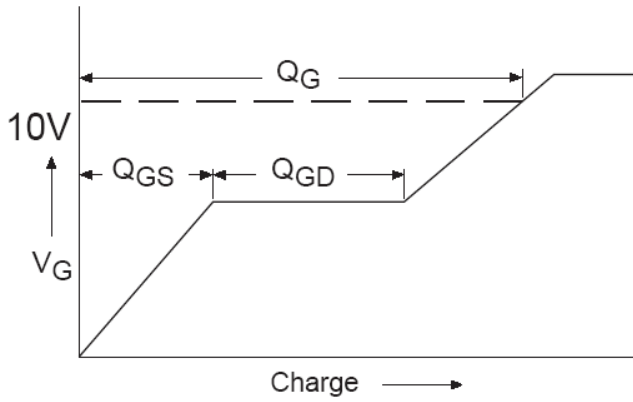
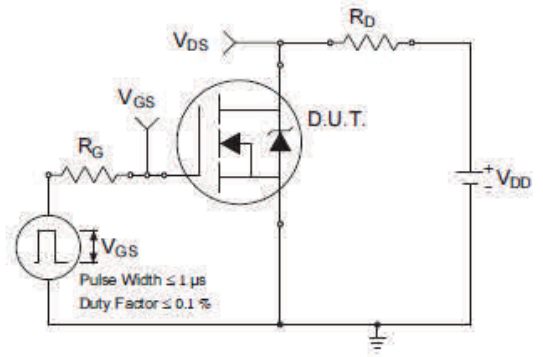
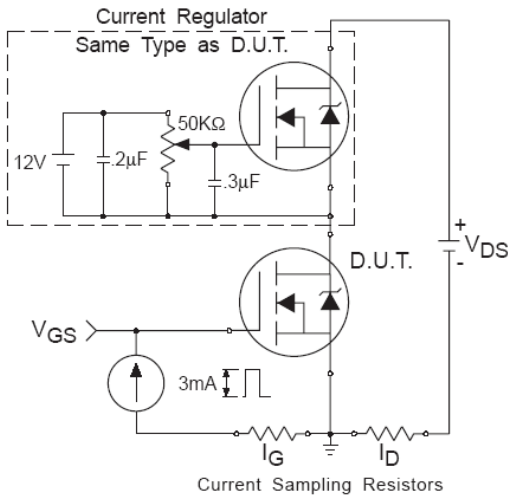
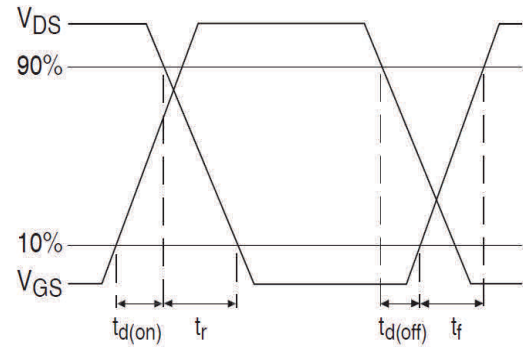
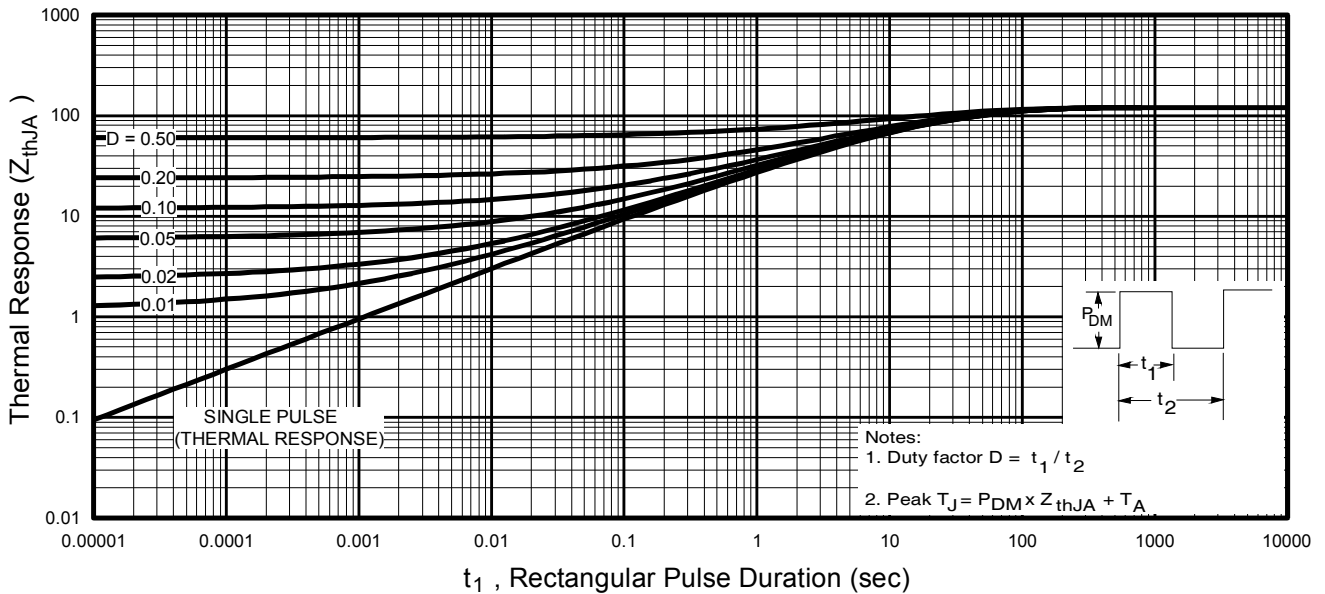
**Fig 6.** Typical Gate Charge vs. Gate-to-Source Voltage

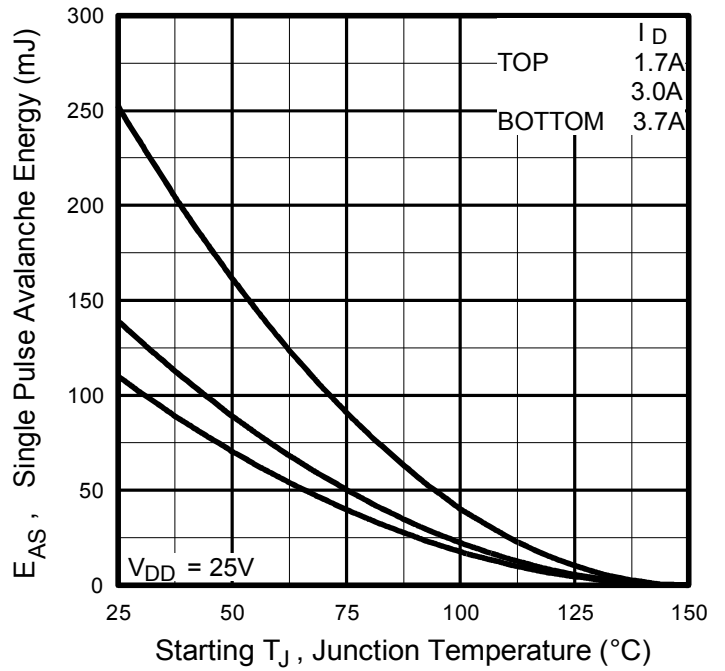


**Fig 7** Typical Source-to-Drain Diode Forward Voltage



**Fig 8.** Maximum Safe Operating Area


**Fig 9a.** Basic Gate Charge Waveform

**Fig 10a.** Switching Time Test Circuit

**Fig 9b.** Gate Charge Test Circuit

**Fig 10b.** Switching Time Waveforms

**Fig 11.** Maximum Effective Transient Thermal Impedance, Junction-to-Ambient

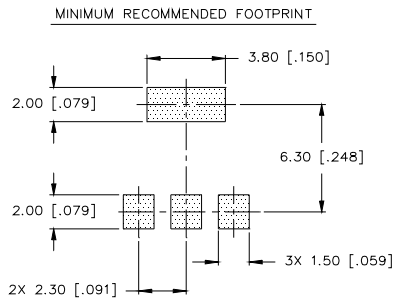
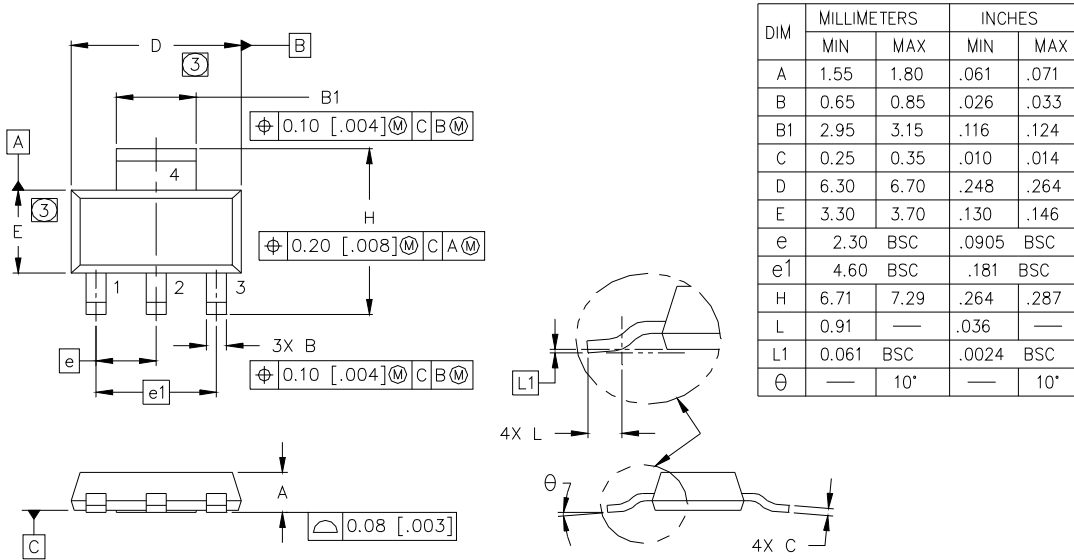

**Fig 12a. Unclamped Inductive Test Circuit**

**Fig 12c. Maximum Avalanche Energy vs. Drain Current**

**Fig 12b. Unclamped Inductive Waveforms**

### Peak Diode Recovery $dv/dt$ Test Circuit



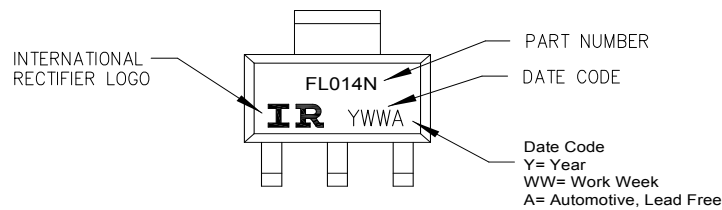
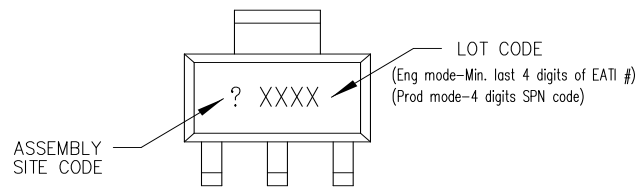
**Fig 13.** Peak Diode Recovery  $dv/dt$  Test Circuit for N-Channel HEXFET® Power MOSFETs

**SOT-223 (TO-261AA) Package Outline** (Dimensions are shown in millimeters (inches))

**LEAD ASSIGNMENTS**

- 1 = GATE
- 2 = DRAIN
- 3 = SOURCE
- 4 = DRAIN

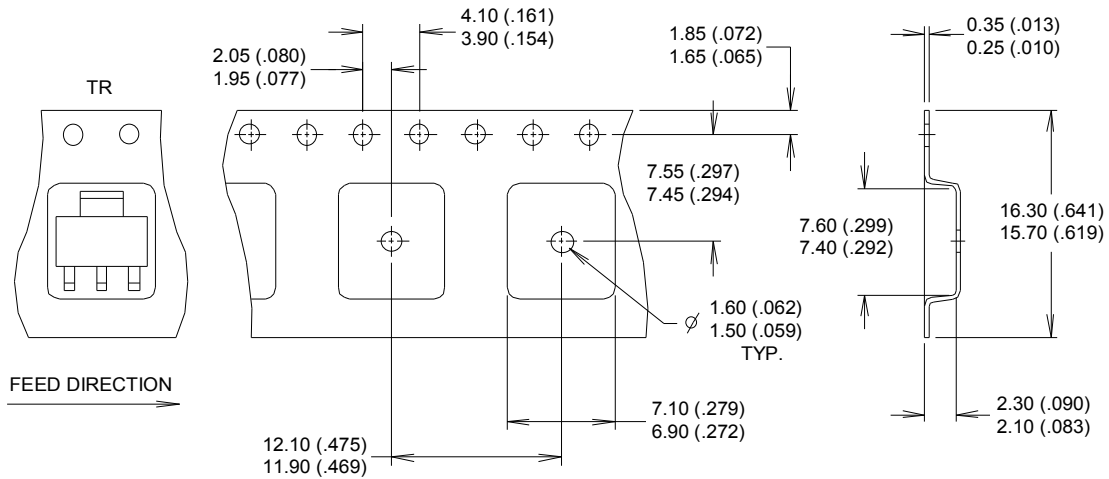
**NOTES:**

1. DIMENSIONING & TOLERANCING PER ASME Y14.5M-1994.
2. CONTROLLING DIMENSION: INCH.
- ③ DIMENSIONS DO NOT INCLUDE MOLD FLASH.
4. OUTLINE CONFORMS TO JEDEC OUTLINE TO-261AA.
5. DIMENSIONS ARE SHOWN IN MILLIMETERS [INCHES].

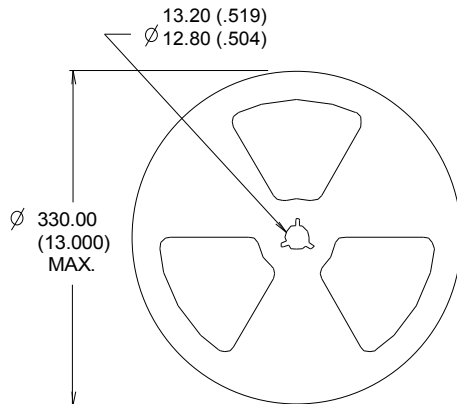
**SOT-223(TO-261AA) Part Marking Information**

**TOP MARKING**

**BOTTOM MARKING**

Note: For the most current drawing please refer to Infineon's web site [www.infineon.com](http://www.infineon.com)

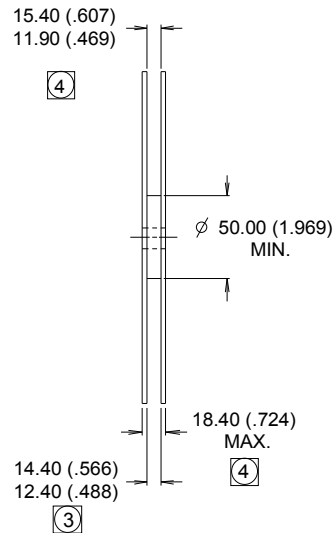


**SOT-223(TO-261AA) Tape and Reel** (Dimensions are shown in millimeters (inches))

**NOTES :**

1. CONTROLLING DIMENSION: MILLIMETER.
2. OUTLINE CONFORMS TO EIA-481 & EIA-541.
3. EACH  $\varnothing 330.00$  (13.00) REEL CONTAINS 2,500 DEVICES.


**NOTES :**

1. OUTLINE COMFORMS TO EIA-418-1.
2. CONTROLLING DIMENSION: MILLIMETER..
- ③ DIMENSION MEASURED @ HUB.
- ④ INCLUDES FLANGE DISTORTION @ OUTER EDGE.



Note: For the most current drawing please refer to Infineon's web site [www.infineon.com](http://www.infineon.com)

**Qualification Information<sup>†</sup>**

<b>Qualification Level</b>	Industrial (per JEDEC JESD47F) <sup>††</sup>	
<b>Moisture Sensitivity Level</b>	SOT-223	MSL1 (per JEDEC J-STD-020D) <sup>††</sup>
<b>RoHS Compliant</b>	Yes	

† Qualification standards can be found at Infineon's web site [www.infineon.com](http://www.infineon.com)

†† Applicable version of JEDEC standard at the time of product release.

**Revision History**

Date	Comments
5/27/2016	<ul style="list-style-type: none"> <li>Updated datasheet with corporate template.</li> <li>Added disclaimer on last page.</li> </ul>

**Trademarks of Infineon Technologies AG**

µHVIC™, µIPM™, µPFC™, AU-ConvertIR™, AURIX™, C166™, CanPAK™, CIPOS™, CIPURSE™, CoolDP™, CoolGaN™, COOLiR™, CoolMOS™, CoolSET™, CoolSiC™, DAVE™, DI-POL™, DirectFET™, DrBlade™, EasyPIM™, EconoBRIDGE™, EconoDUAL™, EconoPACK™, EconoPIM™, EiceDRIVER™, eupec™, FCOS™, GaNpowIR™, HEXFET™, HITFET™, HybridPACK™, iMOTION™, IRAM™, ISOFACE™, IsoPACK™, LEDrivIR™, LITIX™, MIPAQ™, ModSTACK™, my-d™, NovalithIC™, OPTIGA™, OptiMOS™, ORIGA™, PowIRaudio™, PowIRstage™, PrimePACK™, PrimeSTACK™, PROFET™, PRO-SiL™, RASIC™, REAL3™, SmartLEWIS™, SOLID FLASH™, SPOC™, StrongIRFET™, SupIRBuck™, TEMPFET™, TRENCHSTOP™, TriCore™, UHVIC™, XHP™, XMC™

Trademarks updated November 2015

**Other Trademarks**

All referenced product or service names and trademarks are the property of their respective owners.

**Edition 2016-04-19**
**Published by**

**Infineon Technologies AG**  
81726 Munich, Germany

© 2016 Infineon Technologies AG.  
All Rights Reserved.

**Do you have a question about this document?**

Email: [erratum@infineon.com](mailto:erratum@infineon.com)

**Document reference**

ifx1

**IMPORTANT NOTICE**

The information given in this document shall in no event be regarded as a guarantee of conditions or characteristics ("Beschaffenheitsgarantie").

With respect to any examples, hints or any typical values stated herein and/or any information regarding the application of the product, Infineon Technologies hereby disclaims any and all warranties and liabilities of any kind, including without limitation warranties of non-infringement of intellectual property rights of any third party.

In addition, any information given in this document is **subject to customer's compliance with its obligations** stated in this document and any applicable legal requirements, norms and standards concerning customer's products and any use of the product of Infineon Technologies in **customer's applications**.

The data contained in this document is exclusively intended for technically trained staff. It is the **responsibility of customer's technical departments** to evaluate the suitability of the product for the intended application and the completeness of the product information given in this document with respect to such application.

For further information on the product, technology, delivery terms and conditions and prices please contact your nearest Infineon Technologies office ([www.infineon.com](http://www.infineon.com)).

Please note that this product is not qualified according to the AEC Q100 or AEC Q101 documents of the Automotive Electronics Council.

**WARNINGS**

Due to technical requirements products may contain dangerous substances. For information on the types in question please contact your nearest Infineon Technologies office.

Except as otherwise explicitly approved by Infineon Technologies in a written document signed by authorized representatives of Infineon Technologies, **Infineon Technologies' products may not be used** in any applications where a failure of the product or any consequences of the use thereof can reasonably be expected to result in personal injury.

单击下面可查看定价，库存，交付和生命周期等信息

[>>Infineon\(英飞凌\)](#)