

Features

- Advanced Planar Technology
- Ultra Low On-Resistance
- Logic Level Gate Drive
- Dual N and P Channel MOSFET
- Surface Mount
- Available in Tape & Reel
- 150°C Operating Temperature
- Lead-Free, RoHS Compliant
- Automotive Qualified *

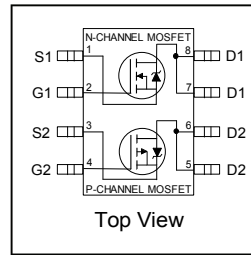

	N-CH	P-CH
V_{DS}	55V	-55V
$R_{DS(on)}$ typ.	0.043Ω	0.095Ω
	max.	0.050Ω
I_D	4.7A	-3.4A



G	D	S
Gate	Drain	Source

Description

Specifically designed for Automotive applications, these HEXFET® Power MOSFET's in a Dual SO-8 package utilize the latest processing techniques to achieve extremely low on-resistance per silicon area. Additional features of these Automotive qualified HEXFET Power MOSFET's are a 150°C junction operating temperature, fast switching speed and improved repetitive avalanche rating. These benefits combine to make this design an extremely efficient and reliable device for use in Automotive applications and a wide variety of other applications.

The efficient SO-8 package provides enhanced thermal characteristics and dual MOSFET die capability making it ideal in a variety of power applications. This dual, surface mount SO-8 can dramatically reduce board space and is also available in Tape & Reel.

Base part number	Package Type	Standard Pack		Orderable Part Number
		Form	Quantity	
AUIRF7343Q	SO-8	Tape and Reel	4000	AUIRF7343QTR

Absolute Maximum Ratings

Stresses beyond those listed under "Absolute Maximum Ratings" may cause permanent damage to the device. These are stress ratings only; and functional operation of the device at these or any other condition beyond those indicated in the specifications is not implied. Exposure to absolute-maximum-rated conditions for extended periods may affect device reliability. The thermal resistance and power dissipation ratings are measured under board mounted and still air conditions. Ambient temperature (TA) is 25°C, unless otherwise specified.

Symbol	Parameter	Max.		Units
		N-Channel	P-Channel	
V_{DS}	Drain-Source Voltage	55	-55	V
$I_D @ T_A = 25^\circ C$	Continuous Drain Current, $V_{GS} @ 10V$	4.7	-3.4	A
$I_D @ T_A = 70^\circ C$	Continuous Drain Current, $V_{GS} @ 10V$	3.8	-2.7	
I_{DM}	Pulsed Drain Current ①	38	-27	
$P_D @ T_A = 25^\circ C$	Maximum Power Dissipation ⑤	2.0		W
$P_D @ T_A = 70^\circ C$	Maximum Power Dissipation ⑤	1.3		
E_{AS}	Single Pulse Avalanche Energy (Thermally Limited) ③	72	114	mJ
I_{AR}	Avalanche Current	4.7	-3.4	A
E_{AR}	Repetitive Avalanche Energy	0.20		mJ
V_{GS}	Gate-to-Source Voltage	± 20		V
dv/dt	Peak Diode Recovery dv/dt ②	5.0	-5.0	V/ns
T_J T_{STG}	Operating Junction and Storage Temperature Range	-55 to + 150		°C

Thermal Resistance

Symbol	Parameter	Typ.	Max.	Units
$R_{\theta JA}$	Junction-to-Ambient (PCB Mount, steady state) ⑤	—	62.5	°C/W

HEXFET® is a registered trademark of Infineon.

*Qualification standards can be found at www.infineon.com

Static @ T_J = 25°C (unless otherwise specified)

	Parameter		Min.	Typ.	Max.	Units	Conditions
V _{(BR)DSS}	Drain-to-Source Breakdown Voltage	N-Ch	55	—	—	V	V _{GS} = 0V, I _D = 250μA
		P-Ch	-55	—	—		V _{GS} = 0V, I _D = -250μA
ΔV _{(BR)DSS} /ΔT _J	Breakdown Voltage Temp. Coefficient	N-Ch	—	0.059	—	V/°C	Reference to 25°C, I _D = 1mA
		P-Ch	—	0.054	—		Reference to 25°C, I _D = -1mA
R _{DS(on)}	Static Drain-to-Source On-Resistance	N-Ch	—	0.043	0.050	Ω	V _{GS} = 10V, I _D = 4.7A ④
			—	0.056	0.065		V _{GS} = 4.5V, I _D = 3.8A ④
		P-Ch	—	0.095	0.105		V _{GS} = -10V, I _D = -3.4A ⑤
			—	0.150	0.170		V _{GS} = -4.5V, I _D = -2.7A ④
V _{GS(th)}	Gate Threshold Voltage	N-Ch	1.0	—	—	V	V _{DS} = V _{GS} , I _D = 250μA
		P-Ch	-1.0	—	—		V _{DS} = V _{GS} , I _D = -250μA
g _{fs}	Forward Trans conductance	N-Ch	7.9	—	—	S	V _{DS} = 10V, I _D = 4.5A④
		P-Ch	3.3	—	—		V _{DS} = -10V, I _D = -3.1A④
I _{DSS}	Drain-to-Source Leakage Current	N-Ch	—	—	2.0	μA	V _{DS} = 55V, V _{GS} = 0V
		P-Ch	—	—	-2.0		V _{DS} = -55V, V _{GS} = 0V
		N-Ch	—	—	25		V _{DS} = 55V, V _{GS} = 0V, T _J = 55°C
		P-Ch	—	—	-25		V _{DS} = -55V, V _{GS} = 0V, T _J = 55°C
I _{GSS}	Gate-to-Source Forward Leakage	N-P	—	—	± 100	nA	V _{GS} = ± 20V
	Gate-to-Source Reverse Leakage	N-P	—	—	± 100		V _{GS} = ± 20V

Dynamic Electrical Characteristics @ T_J = 25°C (unless otherwise specified)

Q _g	Total Gate Charge	N-Ch	—	24	36	nC	N-Channel I _D = 4.5A, V _{DS} = 44V, V _{GS} = 10V ④
		P-Ch	—	26	38		
Q _{gs}	Gate-to-Source Charge	N-Ch	—	2.3	3.4	nC	P-Channel I _D = -3.1A, V _{DS} = -44V, V _{GS} = -10V
		P-Ch	—	3.0	4.5		
Q _{gd}	Gate-to-Drain Charge	N-Ch	—	7.0	10	nC	P-Channel I _D = -3.1A, V _{DS} = -44V, V _{GS} = -10V
		P-Ch	—	8.4	13		
t _{d(on)}	Turn-On Delay Time	N-Ch	—	8.3	12	ns	N-Channel V _{DD} = 28V, I _D = 1.0A, R _G = 6.0Ω, R _D = 28Ω ④
		P-Ch	—	14	22		
t _r	Rise Time	N-Ch	—	3.2	4.8	ns	P-Channel V _{DD} = -28V, I _D = -1.0A, R _G = 6.0Ω, R _D = 28Ω ④
		P-Ch	—	10	15		
t _{d(off)}	Turn-Off Delay Time	N-Ch	—	32	48	ns	P-Channel V _{DD} = -28V, I _D = -1.0A, R _G = 6.0Ω, R _D = 28Ω ④
		P-Ch	—	43	64		
t _f	Fall Time	N-Ch	—	13	20	ns	P-Channel V _{DD} = -28V, I _D = -1.0A, R _G = 6.0Ω, R _D = 28Ω ④
		P-Ch	—	22	32		
C _{iss}	Input Capacitance	N-Ch	—	740	—	pF	N-Channel V _{GS} = 0V, V _{DS} = 25V, f = 1.0MHz
		P-Ch	—	690	—		
C _{oss}	Output Capacitance	N-Ch	—	190	—	pF	P-Channel V _{GS} = 0V, V _{DS} = -25V, f = 1.0MHz
		P-Ch	—	210	—		
C _{rss}	Reverse Transfer Capacitance	N-Ch	—	71	—	pF	P-Channel V _{GS} = 0V, V _{DS} = -25V, f = 1.0MHz
		P-Ch	—	86	—		

Diode Characteristics

	Parameter		Min.	Typ.	Max.	Units	Conditions
I _S	Continuous Source Current (Body Diode)	N-Ch	—	—	2.0	A	
		P-Ch	—	—	-2.0		
I _{SM}	Pulsed Source Current (Body Diode) ①	N-Ch	—	—	38	A	
		P-Ch	—	—	-27		
V _{SD}	Diode Forward Voltage	N-Ch	—	0.70	1.2	V	T _J = 25°C, I _S = 2.0A, V _{GS} = 0V ④
		P-Ch	—	-0.80	-1.2		T _J = 25°C, I _S = -2.0A, V _{GS} = 0V ④
t _{rr}	Reverse Recovery Time	N-Ch	—	60	90	ns	N-Channel T _J = 25°C, I _F = 2.0A, di/dt = 100A/μs
		P-Ch	—	54	80		
Q _{rr}	Reverse Recovery Charge	N-Ch	—	120	170	nC	P-Channel T _J = 25°C, I _F = -2.0A, di/dt = 100A/μs ④
		P-Ch	—	85	130		

Notes:

- ① Repetitive rating; pulse width limited by max. junction temperature. (See Fig. 22)
- ② N-Channel I_{SD} ≤ 4.7A, di/dt ≤ 220A/μs, V_{DD} ≤ V_{(BR)DSS}, T_J ≤ 150°C.
P-Channel I_{SD} ≤ -3.4A, di/dt ≤ -150A/μs, V_{DD} ≤ V_{(BR)DSS}, T_J ≤ 150°C
- ③ N-Channel Starting T_J = 25°C, L = 6.5mH, R_G = 25Ω, I_{AS} = 4.7A.
P-Channel Starting T_J = 25°C, L = 20mH, R_G = 25Ω, I_{AS} = -3.4A.
- ④ Pulse width ≤ 300μs; duty cycle ≤ 2%.
- ⑤ Surface mounted on FR-4 board, t ≤ 10sec.

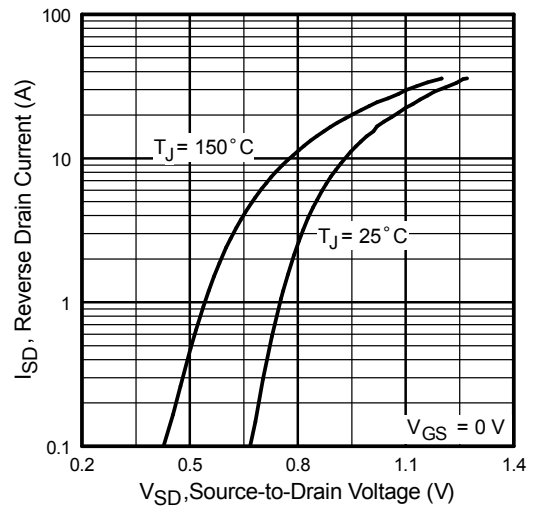
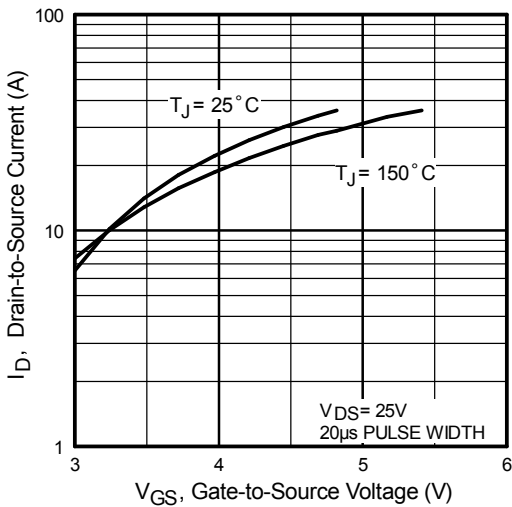
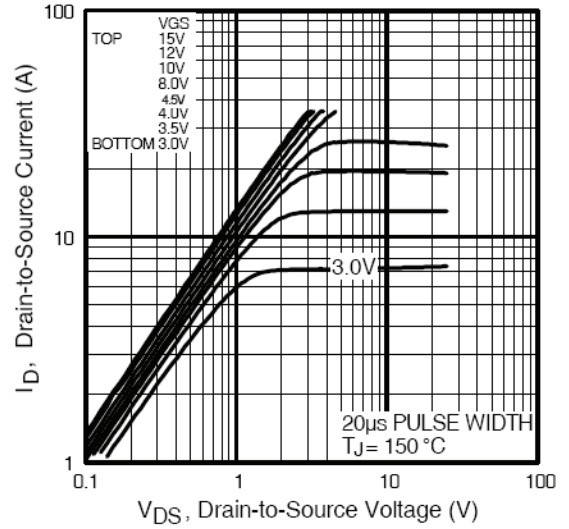
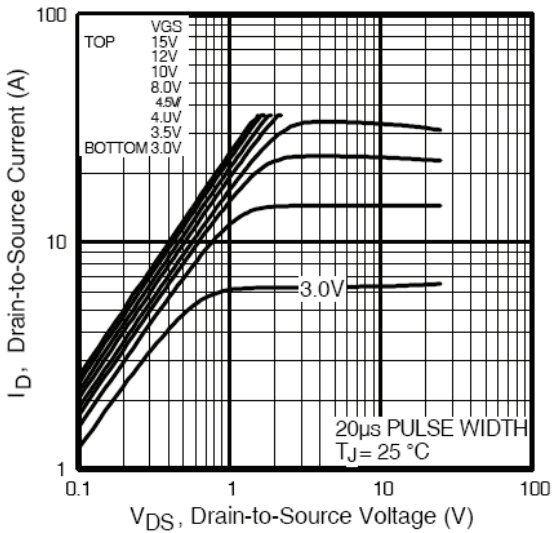

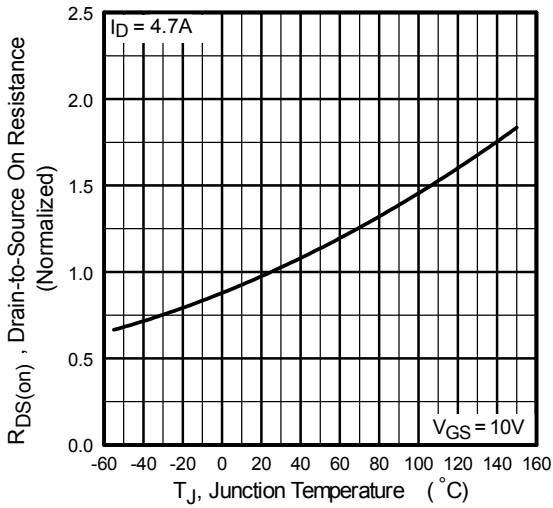

Fig 5. Normalized On-Resistance Vs. Temperature

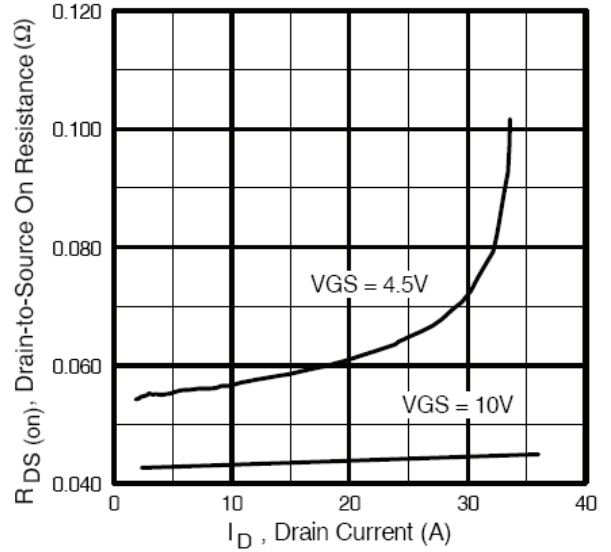

Fig 6. Typical On-Resistance Vs. Drain Current

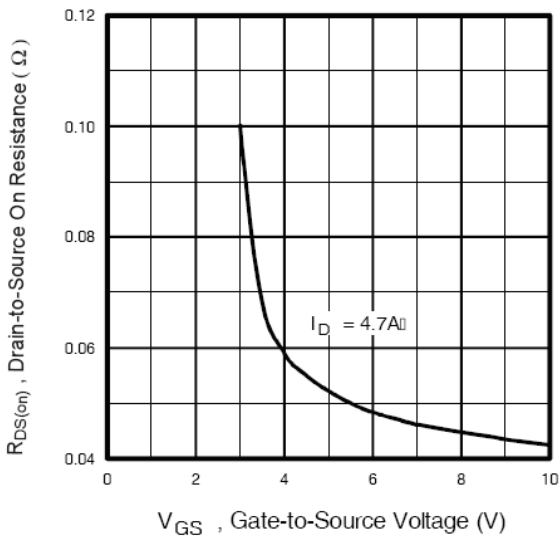

Fig 7 Typical On-Resistance Vs. Gate Voltage

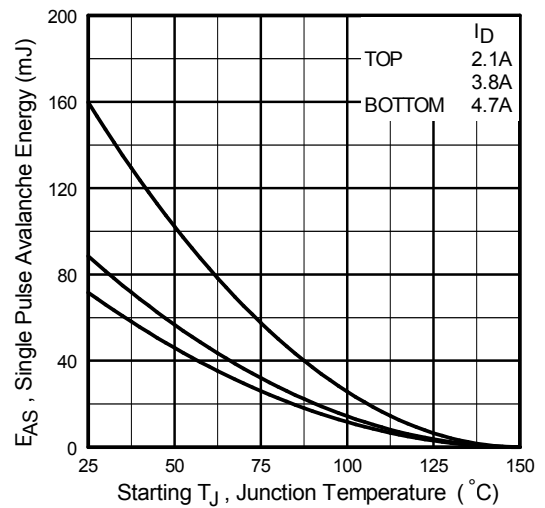

Fig 8. Maximum Avalanche Energy Vs. Drain Current

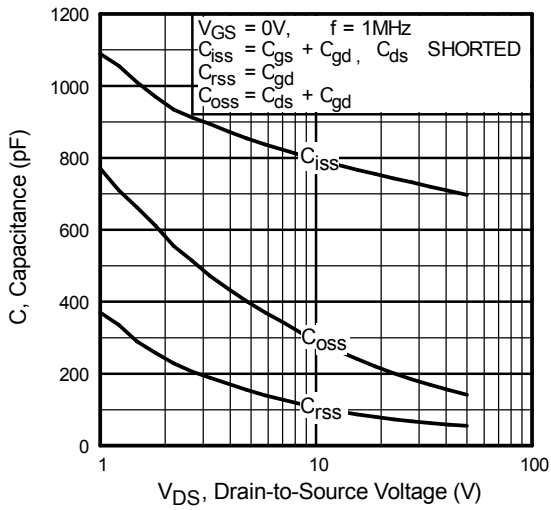

Fig 9. Typical Capacitance Vs. Drain-to-Source Voltage

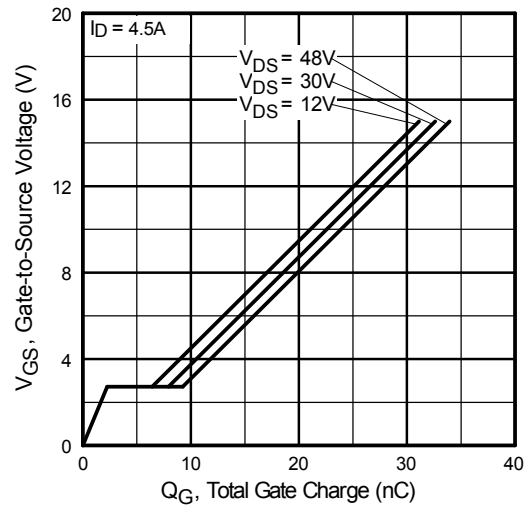

Fig 10. Typical Gate Charge Vs. Gate-to-Source Voltage

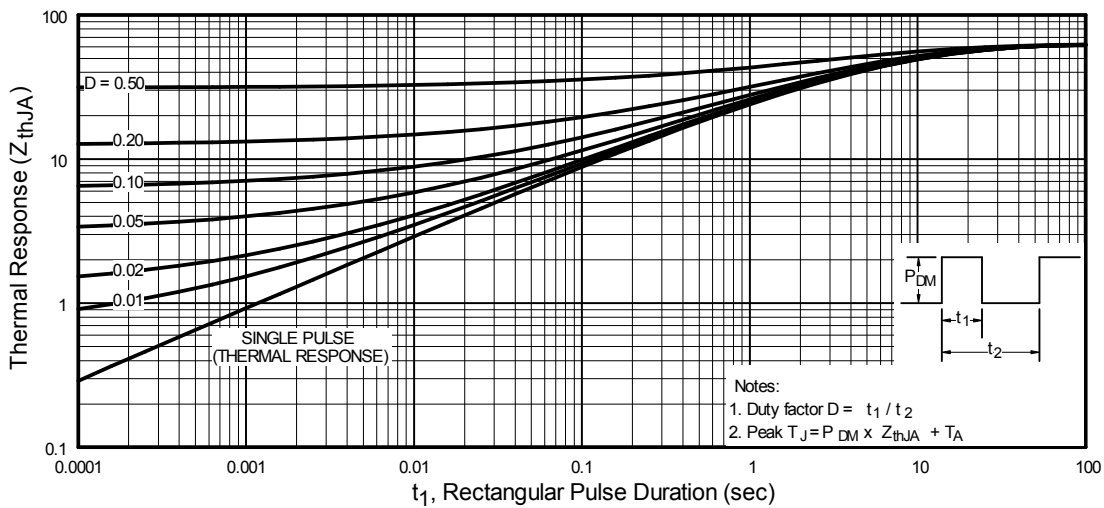

Fig 11. Maximum Effective Transient Thermal Impedance, Junction-to-Ambient

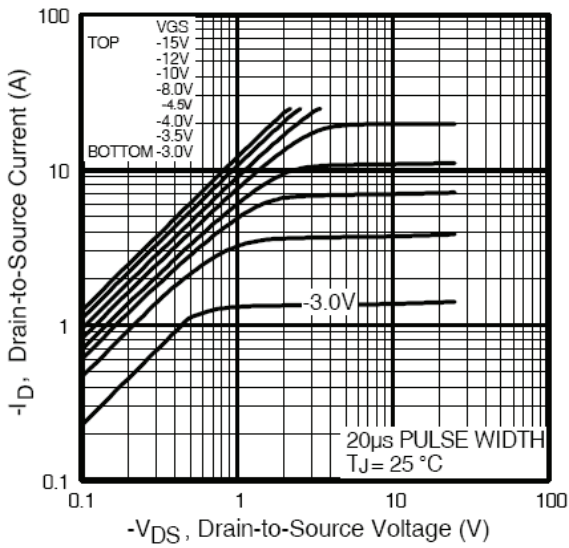

Fig. 12 Typical Output Characteristics

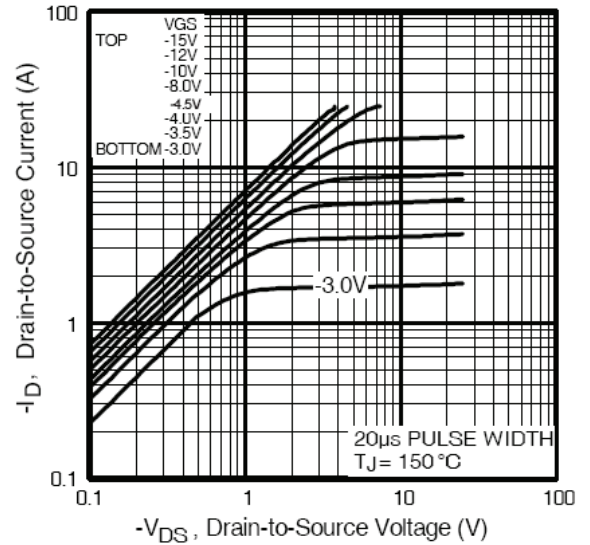

Fig. 13 Typical Output Characteristics

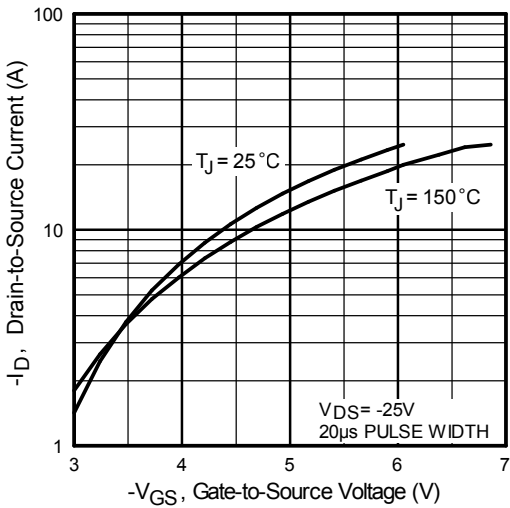

Fig. 14 Typical Transfer Characteristics

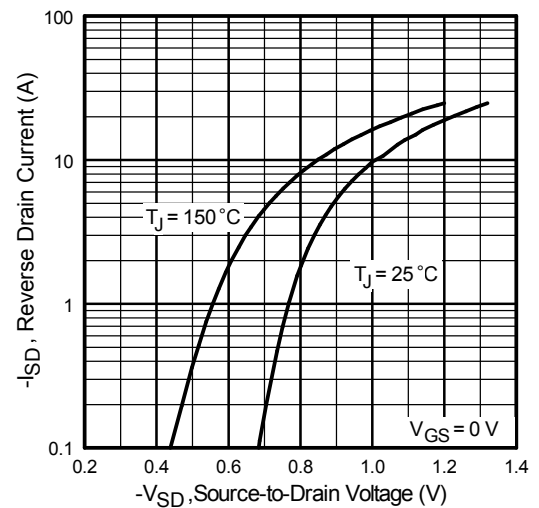

Fig. 15 Typical Source-Drain Diode Forward Voltage

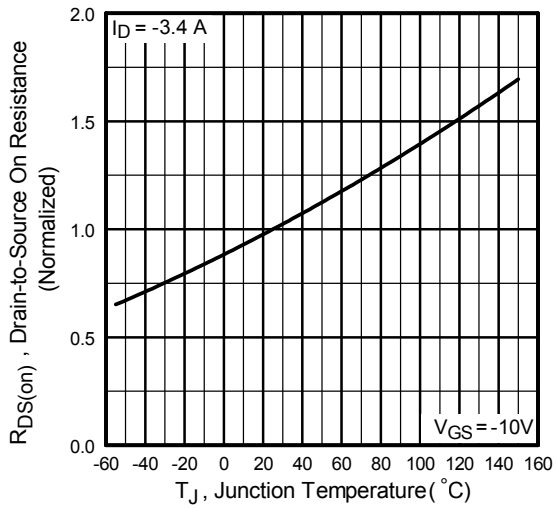

Fig 16. Normalized On-Resistance Vs. Temperature

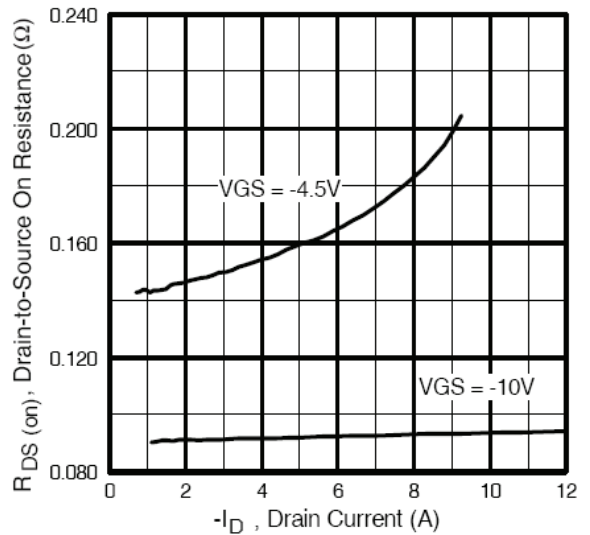

Fig 17. Typical On-Resistance Vs. Drain Current

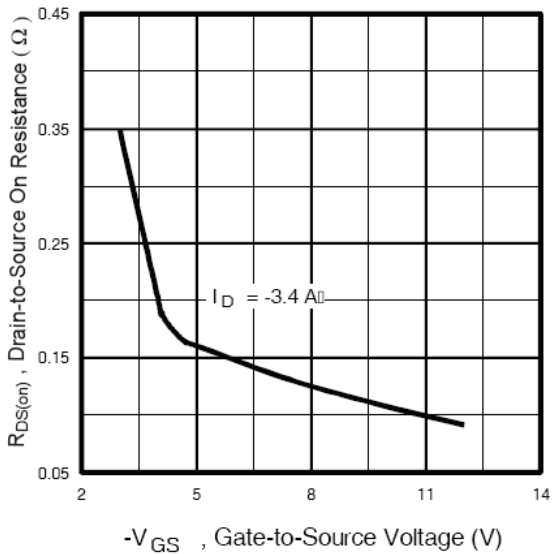

Fig 18 Typical On-Resistance Vs. Gate Voltage

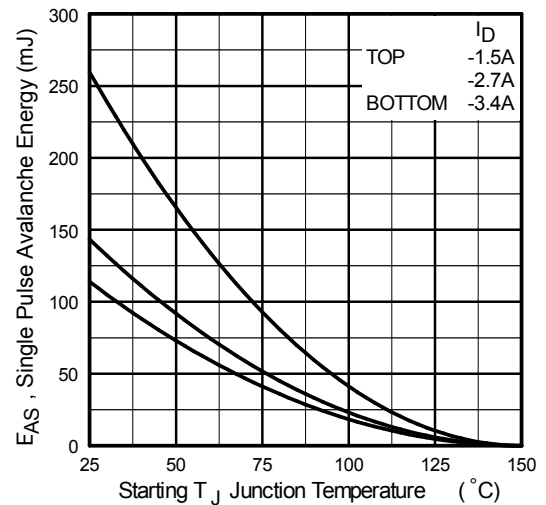

Fig 19. Maximum Avalanche Energy Vs. Drain Current

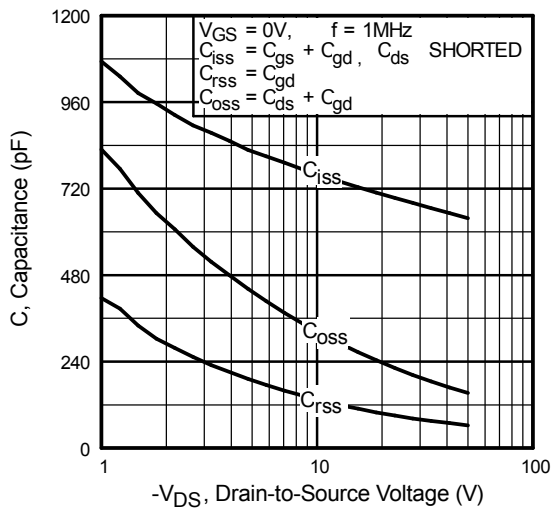

Fig 20. Typical Capacitance Vs. Drain-to-Source Voltage

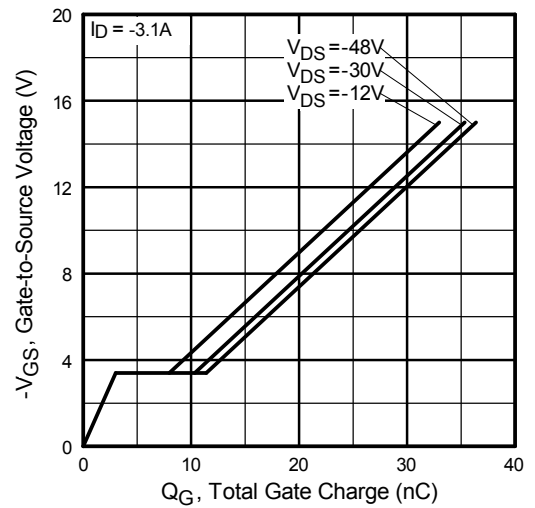

Fig 21. Typical Gate Charge Vs. Gate-to-Source Voltage

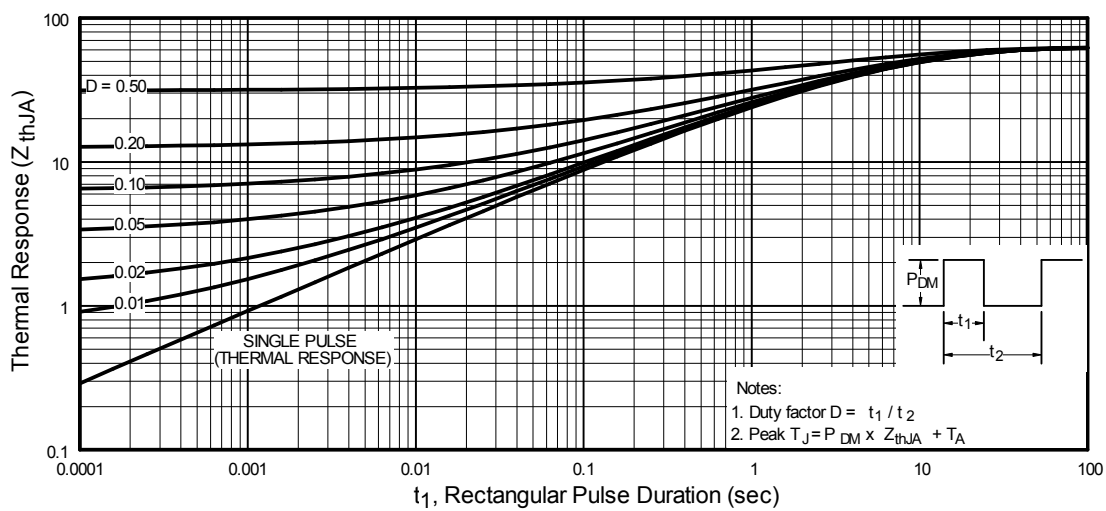
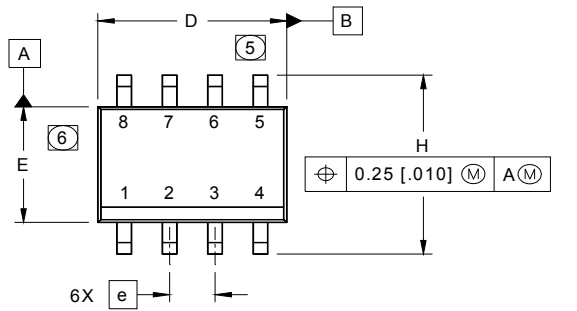
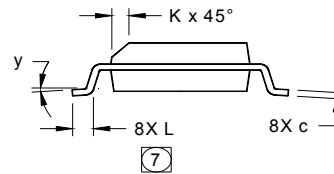
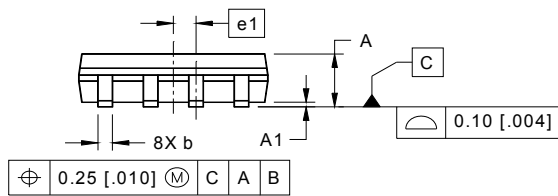

Fig 22. Maximum Effective Transient Thermal Impedance, Junction-to-Ambient

SO-8 Package Outline (Dimensions are shown in millimeters (inches))



DIM	INCHES		MILLIMETERS	
	MIN	MAX	MIN	MAX
A	.0532	.0688	1.35	1.75
A1	.0040	.0098	0.10	0.25
b	.013	.020	0.33	0.51
c	.0075	.0098	0.19	0.25
D	.189	.1968	4.80	5.00
E	.1497	.1574	3.80	4.00
e	.050 BASIC		1.27 BASIC	
e 1	.025 BASIC		0.635 BASIC	
H	.2284	.2440	5.80	6.20
K	.0099	.0196	0.25	0.50
L	.016	.050	0.40	1.27
y	0°	8°	0°	8°



- NOTES:
1. DIMENSIONING & TOLERANCING PER ASME Y14.5M -1994.
 2. CONTROLLING DIMENSION: MILLIMETER
 3. DIMENSIONS ARE SHOWN IN MILLIMETERS [INCHES].
 4. OUTLINE CONFORMS TO JEDEC OUTLINE MS-012AA.
 5. DIMENSION DOES NOT INCLUDE MOLD PROTRUSIONS. MOLD PROTRUSIONS NOT TO EXCEED 0.15 [.006].
 6. DIMENSION DOES NOT INCLUDE MOLD PROTRUSIONS. MOLD PROTRUSIONS NOT TO EXCEED 0.25 [.010].
 7. DIMENSION IS THE LENGTH OF LEAD FOR SOLDERING TO A SUBSTRATE.

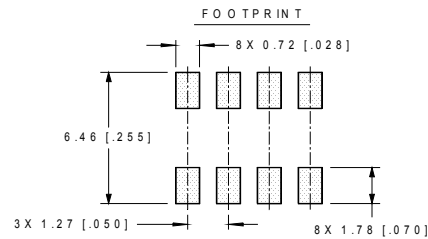

SO-8 Part Marking Information

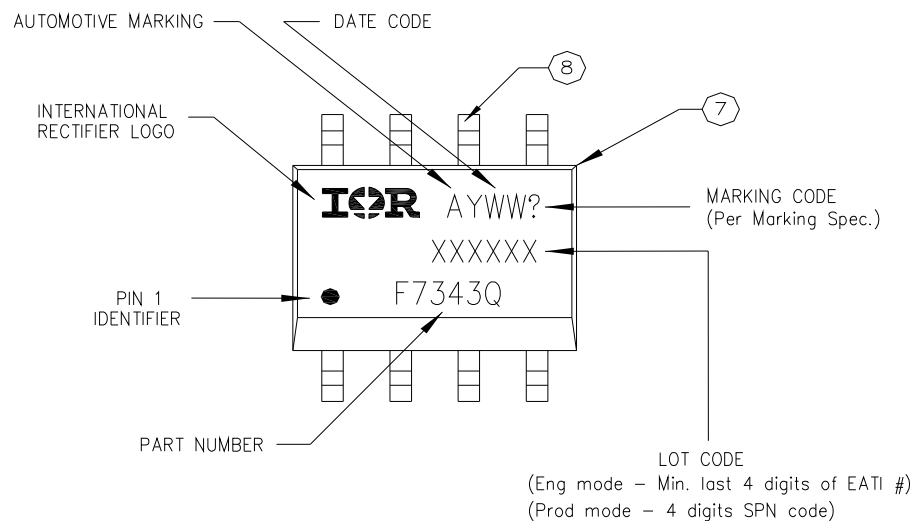

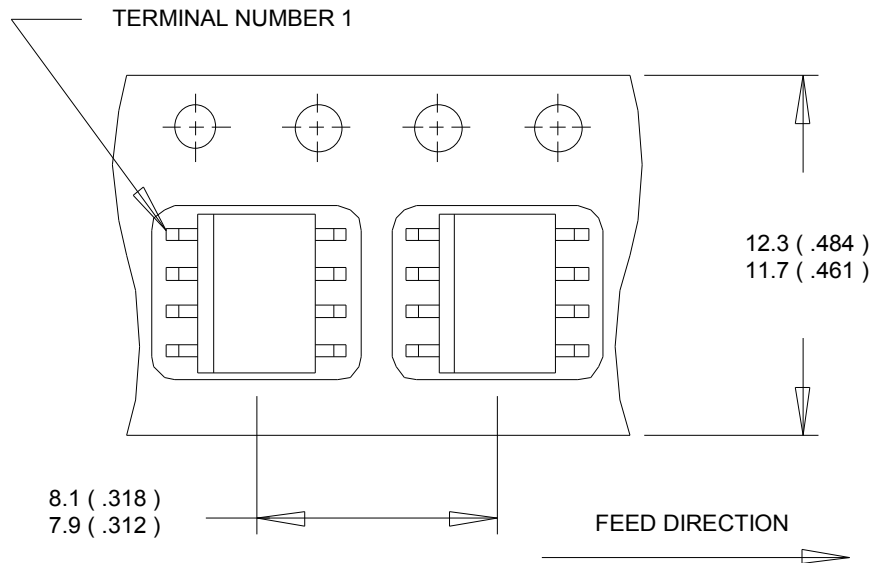
SO-8 Tape and Reel (Dimensions are shown in millimeters (inches))

NOTES:

1. CONTROLLING DIMENSION : MILLIMETER.
2. ALL DIMENSIONS ARE SHOWN IN MILLIMETERS(INCHES).
3. OUTLINE CONFORMS TO EIA-481 & EIA-541.

NOTES :

1. CONTROLLING DIMENSION : MILLIMETER.
2. OUTLINE CONFORMS TO EIA-481 & EIA-541.

Qualification Information

Qualification Level		Automotive (per AEC-Q101)	
		Comments: This part number(s) passed Automotive qualification. Infineon's Industrial and Consumer qualification level is granted by extension of the higher Automotive level.	
Moisture Sensitivity Level		SO-8	MSL1
ESD	Machine Model	Class M2 (+/- 200V) [†] AEC-Q101-002	
	Human Body Model	Class H1A (+/- 500V) [†] AEC-Q101-001	
	Charged Device Model	Class C5 (+/- 1125V) [†] AEC-Q101-005	
RoHS Compliant		Yes	

† Highest passing voltage.

Revision History

Date	Comments
3/10/2014	<ul style="list-style-type: none"> Added "Logic Level Gate Drive" bullet in the features section on page 1 Updated data sheet with new IR corporate template
9/30/2015	<ul style="list-style-type: none"> Updated datasheet with corporate template Corrected ordering table on page 1.

Published by

Infineon Technologies AG
81726 München, Germany

© Infineon Technologies AG 2015

All Rights Reserved.

IMPORTANT NOTICE

The information given in this document shall in no event be regarded as a guarantee of conditions or characteristics ("Beschaffheitsgarantie"). With respect to any examples, hints or any typical values stated herein and/or any information regarding the application of the product, Infineon Technologies hereby disclaims any and all warranties and liabilities of any kind, including without limitation warranties of non-infringement of intellectual property rights of any third party.

In addition, any information given in this document is subject to customer's compliance with its obligations stated in this document and any applicable legal requirements, norms and standards concerning customer's products and any use of the product of Infineon Technologies in customer's applications.

The data contained in this document is exclusively intended for technically trained staff. It is the responsibility of customer's technical departments to evaluate the suitability of the product for the intended application and the completeness of the product information given in this document with respect to such application.

For further information on the product, technology, delivery terms and conditions and prices please contact your nearest Infineon Technologies office (www.infineon.com).

WARNINGS

Due to technical requirements products may contain dangerous substances. For information on the types in question please contact your nearest Infineon Technologies office.

Except as otherwise explicitly approved by Infineon Technologies in a written document signed by authorized representatives of Infineon Technologies, Infineon Technologies' products may not be used in any applications where a failure of the product or any consequences of the use thereof can reasonably be expected to result in personal injury.

单击下面可查看定价，库存，交付和生命周期等信息

[>>Infineon Technologies\(英飞凌\)](#)