

Low Noise Silicon Bipolar RF Transistor

- For low-noise, high gain broadband amplifiers at collector currents from 2 mA to 30 mA
- Pb-free (RoHS compliant) package
- Qualification report according to AEC-Q101 available

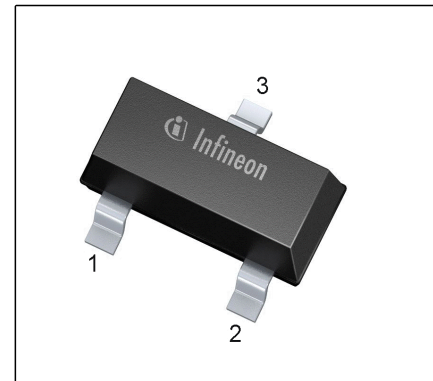

ESD (Electrostatic discharge) sensitive device, observe handling precaution!

Type	Marking	Pin Configuration			Package
BFR93A	R2s	1=B	2=E	3=C	SOT23

Maximum Ratings at $T_A = 25\text{ }^\circ\text{C}$, unless otherwise specified

Parameter	Symbol	Value	Unit
Collector-emitter voltage	V_{CEO}	12	V
Collector-emitter voltage	V_{CES}	20	
Collector-base voltage	V_{CBO}	20	
Emitter-base voltage	V_{EBO}	2	
Collector current	I_C	90	mA
Base current	I_B	9	
Total power dissipation ¹⁾ $T_S \leq 111\text{ }^\circ\text{C}$	P_{tot}	300	mW
Junction temperature	T_J	150	$^\circ\text{C}$
Storage temperature	T_{Stg}	-55 ... 150	

Thermal Resistance

Parameter	Symbol	Value	Unit
Junction - soldering point ²⁾	R_{thJS}	130	K/W

¹⁾ T_S is measured on the collector lead at the soldering point to the pcb

²⁾ For the definition of R_{thJS} please refer to Application Note AN077 (Thermal Resistance Calculation)

Electrical Characteristics at $T_A = 25\text{ °C}$, unless otherwise specified

Parameter	Symbol	Values			Unit
		min.	typ.	max.	
DC Characteristics					
Collector-emitter breakdown voltage $I_C = 1\text{ mA}, I_B = 0$	$V_{(BR)CEO}$	12	-	-	V
Collector-emitter cutoff current $V_{CE} = 20\text{ V}, V_{BE} = 0$	I_{CES}	-	-	100	μA
Collector-base cutoff current $V_{CB} = 10\text{ V}, I_E = 0$	I_{CBO}	-	-	100	nA
Emitter-base cutoff current $V_{EB} = 2.5\text{ V}, I_C = 0$	I_{EBO}	-	-	10	μA
DC current gain $I_C = 30\text{ mA}, V_{CE} = 8\text{ V}, \text{ pulse measured}$	h_{FE}	70	100	140	-

Electrical Characteristics at $T_A = 25\text{ }^\circ\text{C}$, unless otherwise specified

Parameter	Symbol	Values			Unit
		min.	typ.	max.	
AC Characteristics (verified by random sampling)					
Transition frequency $I_C = 30\text{ mA}$, $V_{CE} = 8\text{ V}$, $f = 500\text{ MHz}$	f_T	4.5	6	-	GHz
Collector-base capacitance $V_{CB} = 10\text{ V}$, $f = 1\text{ MHz}$, $V_{BE} = 0$, emitter grounded	C_{cb}	-	0.54	0.8	pF
Collector emitter capacitance $V_{CE} = 10\text{ V}$, $f = 1\text{ MHz}$, $V_{BE} = 0$, base grounded	C_{ce}	-	0.25	-	
Emitter-base capacitance $V_{EB} = 0.5\text{ V}$, $f = 1\text{ MHz}$, $V_{CB} = 0$, collector grounded	C_{eb}	-	1.9	-	
Minimum noise figure $I_C = 5\text{ mA}$, $V_{CE} = 8\text{ V}$, $Z_S = Z_{Sopt}$, $f = 900\text{ MHz}$ $f = 1.8\text{ GHz}$	NF_{min}	-	1.5	-	dB
Power gain, maximum available ¹⁾ $I_C = 30\text{ mA}$, $V_{CE} = 8\text{ V}$, $Z_S = Z_{Sopt}$, $Z_L = Z_{Lopt}$, $f = 900\text{ MHz}$ $f = 1.8\text{ GHz}$	G_{ma}	-	14.5	-	
Transducer gain $I_C = 30\text{ mA}$, $V_{CE} = 8\text{ V}$, $Z_S = Z_L = 50\text{ }\Omega$, $f = 900\text{ MHz}$ $f = 1.8\text{ MHz}$	$ S_{21e} ^2$	-	12.5	-	dB
Third order intercept point at output ²⁾ $I_C = 30\text{ mA}$, $V_{CE} = 8\text{ V}$, $Z_S = Z_L = 50\text{ }\Omega$, $f = 900\text{ MHz}$	IP_3	-	15	-	dBm
1dB Compression point $I_C = 30\text{ mA}$, $V_{CE} = 8\text{ V}$, $Z_S = Z_L = 50\text{ }\Omega$, $f = 900\text{ MHz}$	P_{-1dB}	-	6	-	

$$^1G_{ma} = |S_{21e} / S_{12e}| (k - (k^2 - 1)^{1/2})$$

²IP3 value depends on termination of all intermodulation frequency components.

Termination used for this measurement is 50Ω from 0.2 MHz to 12 GHz

Total power dissipation $P_{\text{tot}} = f(T_S)$

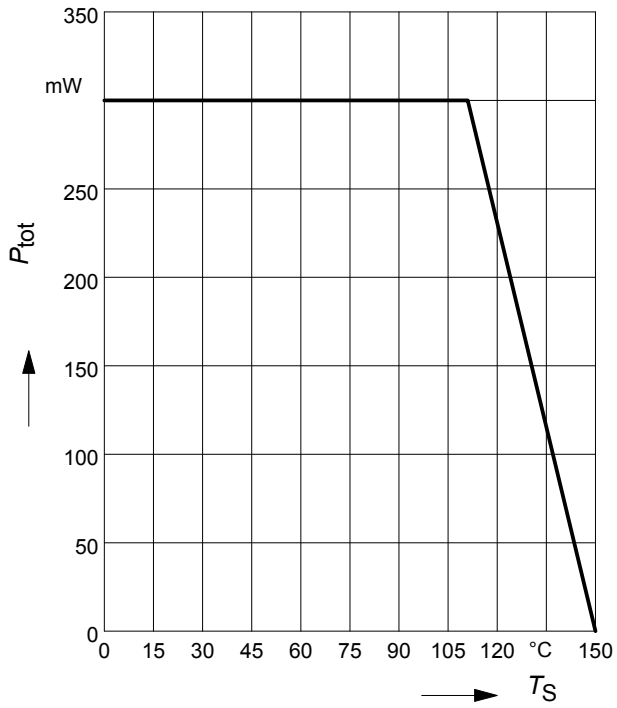

Package Outline

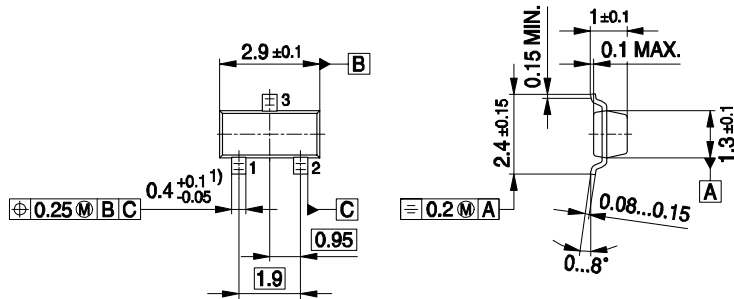
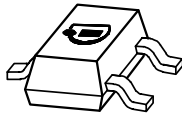

1) Lead width can be 0.6 max. in dambar area

SOT23-PO V08

Foot Print

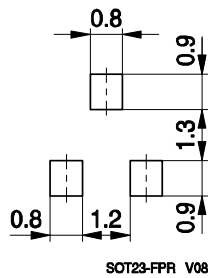

Marking Layout

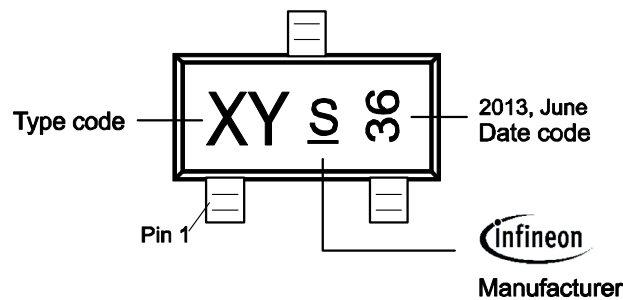

Standard Packing

Reel o 180 mm: 3.000 Pieces / Reel
 Reel o 330 mm = 10.000 Pieces / Reel

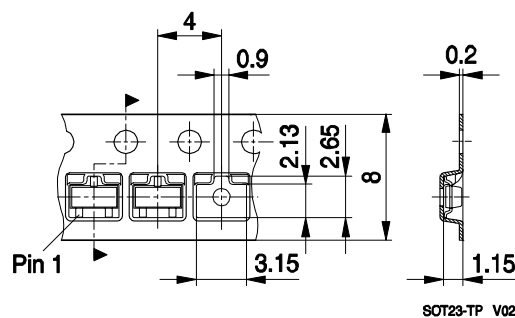

Edition 2009-11-16

**Published by
Infineon Technologies AG
81726 Munich, Germany**

**© 2009 Infineon Technologies AG
All Rights Reserved.**

Legal Disclaimer

The information given in this document shall in no event be regarded as a guarantee of conditions or characteristics. With respect to any examples or hints given herein, any typical values stated herein and/or any information regarding the application of the device, Infineon Technologies hereby disclaims any and all warranties and liabilities of any kind, including without limitation, warranties of non-infringement of intellectual property rights of any third party.

Information

For further information on technology, delivery terms and conditions and prices, please contact the nearest Infineon Technologies Office (www.infineon.com).

Warnings

Due to technical requirements, components may contain dangerous substances. For information on the types in question, please contact the nearest Infineon Technologies Office.

Infineon Technologies components may be used in life-support devices or systems only with the express written approval of Infineon Technologies, if a failure of such components can reasonably be expected to cause the failure of that life-support device or system or to affect the safety or effectiveness of that device or system. Life support devices or systems are intended to be implanted in the human body or to support and/or maintain and sustain and/or protect human life. If they fail, it is reasonable to assume that the health of the user or other persons may be endangered.

单击下面可查看定价，库存，交付和生命周期等信息

[>>Infineon Technologies\(英飞凌\)](#)