

HEXFET® Power MOSFET

$V_{DS}$	<b>-20</b>	<b>V</b>
$R_{DS(on) \max}$ (@ $V_{GS} = -4.5V$ )	<b>8.2</b>	<b>mΩ</b>
$R_{DS(on) \max}$ (@ $V_{GS} = -2.5V$ )	<b>13</b>	
$Q_g$ (typical)	<b>87</b>	<b>nC</b>
$I_b$ (@ $T_A = 25^\circ C$ )	<b>-15</b>	<b>A</b>

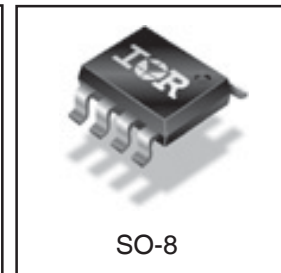
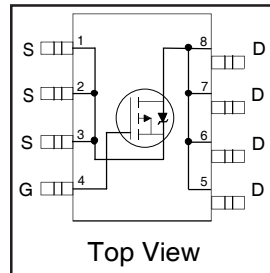

**Features**

Industry-standard pinout SO-8 Package
Compatible with Existing Surface Mount Techniques
RoHS Compliant, Halogen-Free
MSL1, Industrial qualification



**Benefits**

Multi-Vendor Compatibility
Easier Manufacturing
Environmentally Friendlier
Increased Reliability

Base Part Number	Package Type	Standard Pack		Orderable Part Number
		Form	Quantity	
IRF7425PbF-1	SO-8	Tube/Bulk	95	IRF7425PbF-1
		Tape and Reel	4000	IRF7425TRPbF-1

**Absolute Maximum Ratings**

	Parameter	Max.	Units
$V_{DS}$	Drain- Source Voltage	-20	V
$I_D @ T_A = 25^\circ C$	Continuous Drain Current, $V_{GS} @ -4.5V$	-15	A
$I_D @ T_A = 70^\circ C$	Continuous Drain Current, $V_{GS} @ -4.5V$	-12	
$I_{DM}$	Pulsed Drain Current ①	-60	
$P_D @ T_A = 25^\circ C$	Power Dissipation ③	2.5	W
$P_D @ T_A = 70^\circ C$	Power Dissipation ③	1.6	
	Linear Derating Factor	20	mW/°C
$V_{GS}$	Gate-to-Source Voltage	± 12	V
$T_J, T_{STG}$	Junction and Storage Temperature Range	-55 to + 150	°C

**Thermal Resistance**

	Parameter	Max.	Units
$R_{\theta JA}$	Maximum Junction-to-Ambient③	50	°C/W

**Electrical Characteristics @ T<sub>J</sub> = 25°C (unless otherwise specified)**

	Parameter	Min.	Typ.	Max.	Units	Conditions
V <sub>(BR)DSS</sub>	Drain-to-Source Breakdown Voltage	-20	—	—	V	V <sub>GS</sub> = 0V, I <sub>D</sub> = -250μA
ΔV <sub>(BR)DSS</sub> /ΔT <sub>J</sub>	Breakdown Voltage Temp. Coefficient	—	0.010	—	V/°C	Reference to 25°C, I <sub>D</sub> = -1mA
R <sub>DS(on)</sub>	Static Drain-to-Source On-Resistance	—	—	8.2	mΩ	V <sub>GS</sub> = -4.5V, I <sub>D</sub> = -15A ②
		—	—	13		V <sub>GS</sub> = -2.5V, I <sub>D</sub> = -13A ②
V <sub>GS(th)</sub>	Gate Threshold Voltage	-0.45	—	-1.2	V	V <sub>DS</sub> = V <sub>GS</sub> , I <sub>D</sub> = -250μA
g <sub>fs</sub>	Forward Transconductance	44	—	—	S	V <sub>DS</sub> = -10V, I <sub>D</sub> = -15A
I <sub>DSS</sub>	Drain-to-Source Leakage Current	—	—	-1.0	μA	V <sub>DS</sub> = -16V, V <sub>GS</sub> = 0V
		—	—	-25		V <sub>DS</sub> = -16V, V <sub>GS</sub> = 0V, T <sub>J</sub> = 70°C
I <sub>GSS</sub>	Gate-to-Source Forward Leakage	—	—	-100	nA	V <sub>GS</sub> = -12V
	Gate-to-Source Reverse Leakage	—	—	100		V <sub>GS</sub> = 12V
Q <sub>g</sub>	Total Gate Charge	—	87	130	nC	I <sub>D</sub> = -15A
Q <sub>gs</sub>	Gate-to-Source Charge	—	18	27		V <sub>DS</sub> = -10V
Q <sub>gd</sub>	Gate-to-Drain ("Miller") Charge	—	21	32		V <sub>GS</sub> = -4.5V
t <sub>d(on)</sub>	Turn-On Delay Time	—	13	—	ns	V <sub>DD</sub> = -10V ②
t <sub>r</sub>	Rise Time	—	20	—		I <sub>D</sub> = -1.0A
t <sub>d(off)</sub>	Turn-Off Delay Time	—	230	—		R <sub>G</sub> = 6.0Ω
t <sub>f</sub>	Fall Time	—	160	—		V <sub>GS</sub> = -4.5V
C <sub>iss</sub>	Input Capacitance	—	7980	—	pF	V <sub>GS</sub> = 0V
C <sub>oss</sub>	Output Capacitance	—	1480	—		V <sub>DS</sub> = -15V
C <sub>rss</sub>	Reverse Transfer Capacitance	—	980	—		f = 1.0kHz

**Source-Drain Ratings and Characteristics**

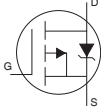
	Parameter	Min.	Typ.	Max.	Units	Conditions
I <sub>S</sub>	Continuous Source Current (Body Diode)	—	—	-2.5	A	MOSFET symbol showing the integral reverse p-n junction diode. 
I <sub>SM</sub>	Pulsed Source Current (Body Diode) ①	—	—	-60		
V <sub>SD</sub>	Diode Forward Voltage	—	—	-1.2	V	T <sub>J</sub> = 25°C, I <sub>S</sub> = -2.5A, V <sub>GS</sub> = 0V ②
t <sub>rr</sub>	Reverse Recovery Time	—	120	180	ns	T <sub>J</sub> = 25°C, I <sub>F</sub> = -2.5A
Q <sub>rr</sub>	Reverse Recovery Charge	—	160	240	nC	di/dt = -100A/μs ②

**Notes:**

- ① Repetitive rating; pulse width limited by max. junction temperature.
- ② Pulse width ≤ 400μs; duty cycle ≤ 2%.
- ③ Surface mounted on 1 in square Cu board, t ≤ 10sec.

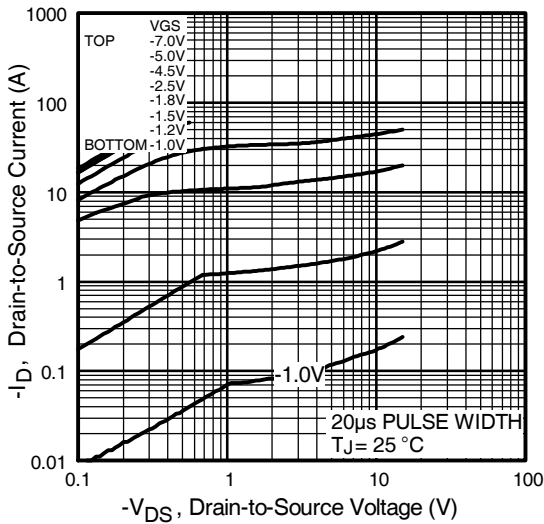
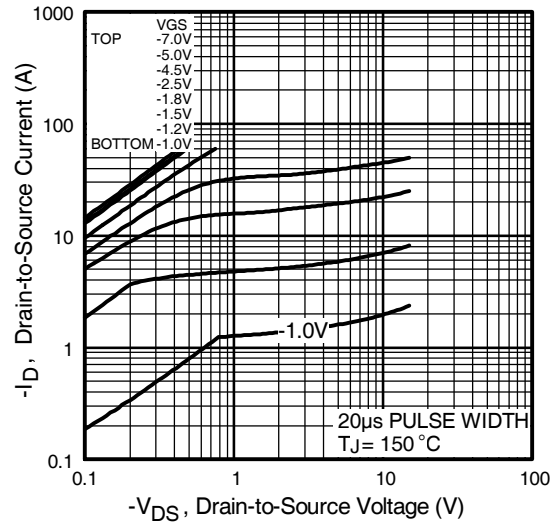
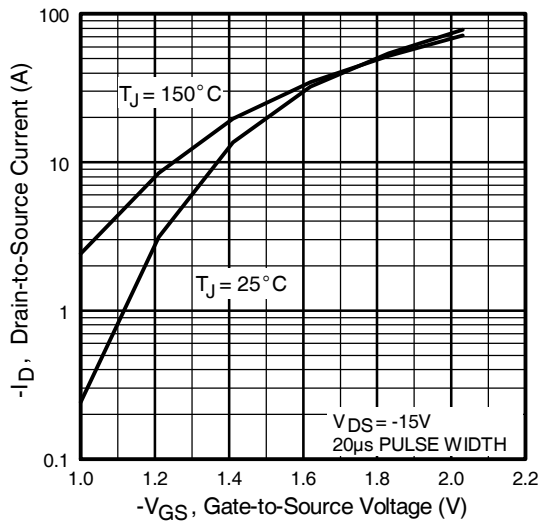
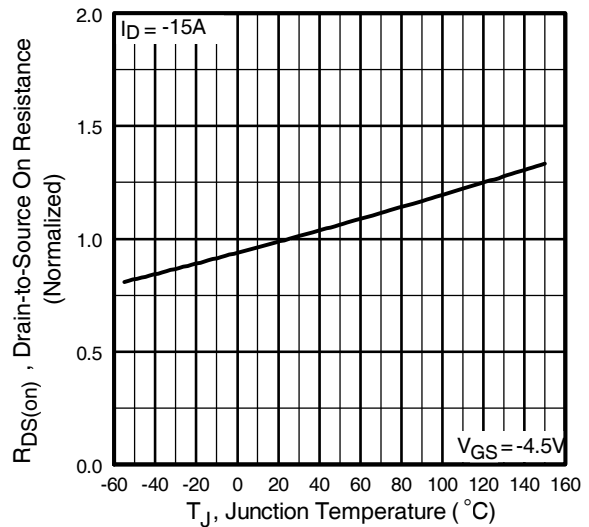
**Fig 1.** Typical Output Characteristics

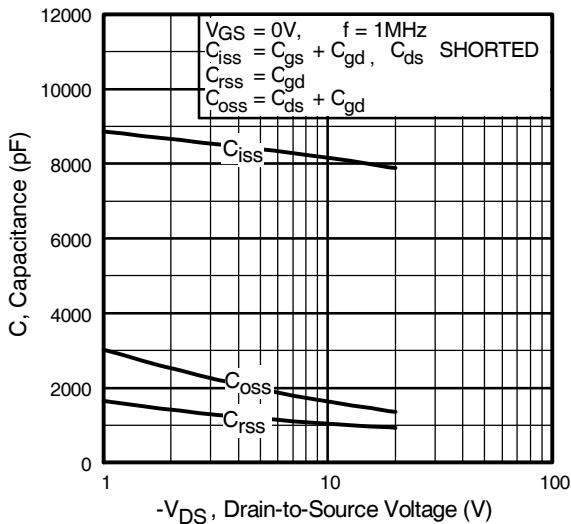
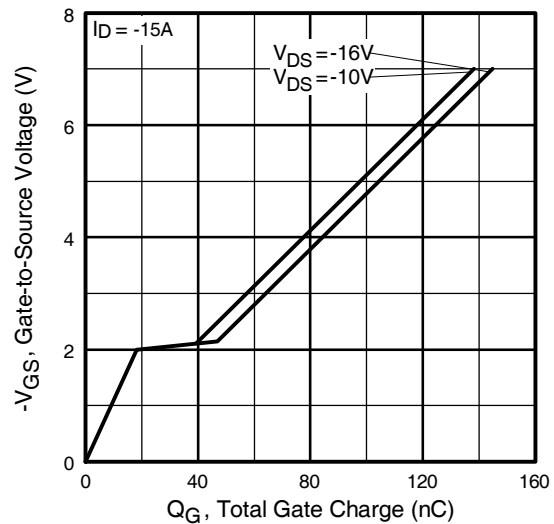
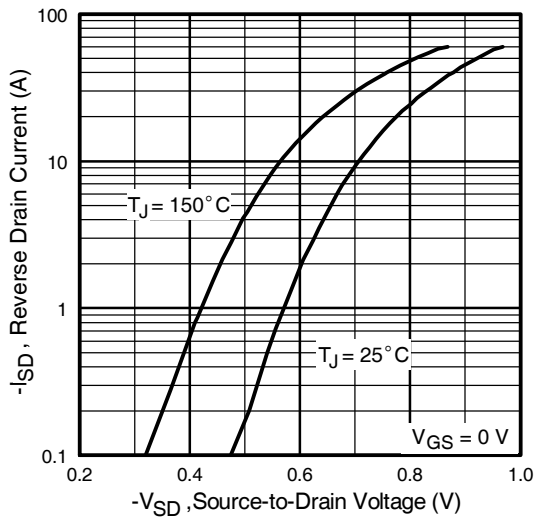
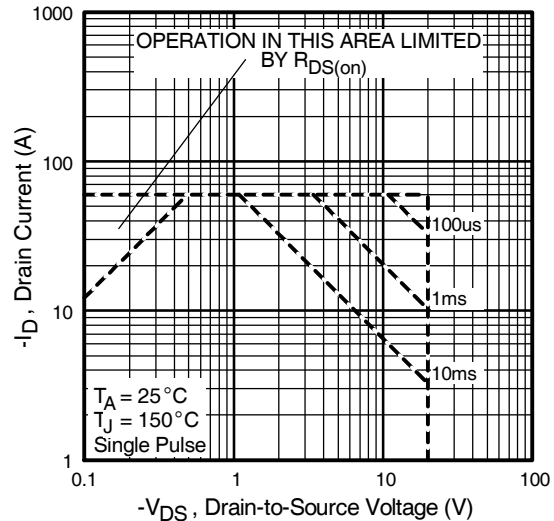
**Fig 2.** Typical Output Characteristics

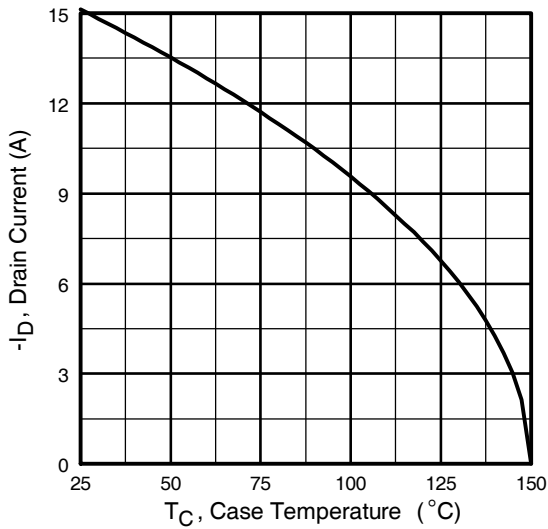
**Fig 3.** Typical Transfer Characteristics

**Fig 4.** Normalized On-Resistance Vs. Temperature

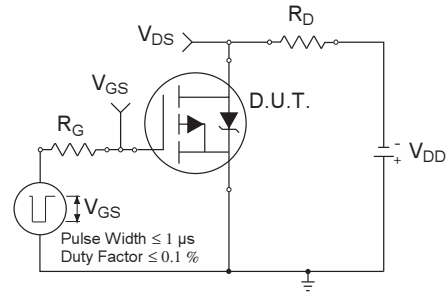
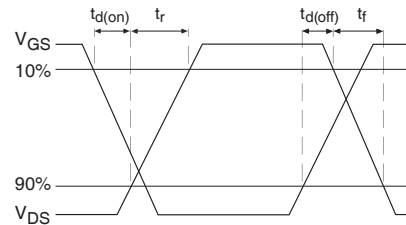

**Fig 5.** Typical Capacitance Vs. Drain-to-Source Voltage

**Fig 6.** Typical Gate Charge Vs. Gate-to-Source Voltage

**Fig 7.** Typical Source-Drain Diode Forward Voltage

**Fig 8.** Maximum Safe Operating Area



**Fig 9.** Maximum Drain Current Vs. Case Temperature



**Fig 10a.** Switching Time Test Circuit



**Fig 10b.** Switching Time Waveforms

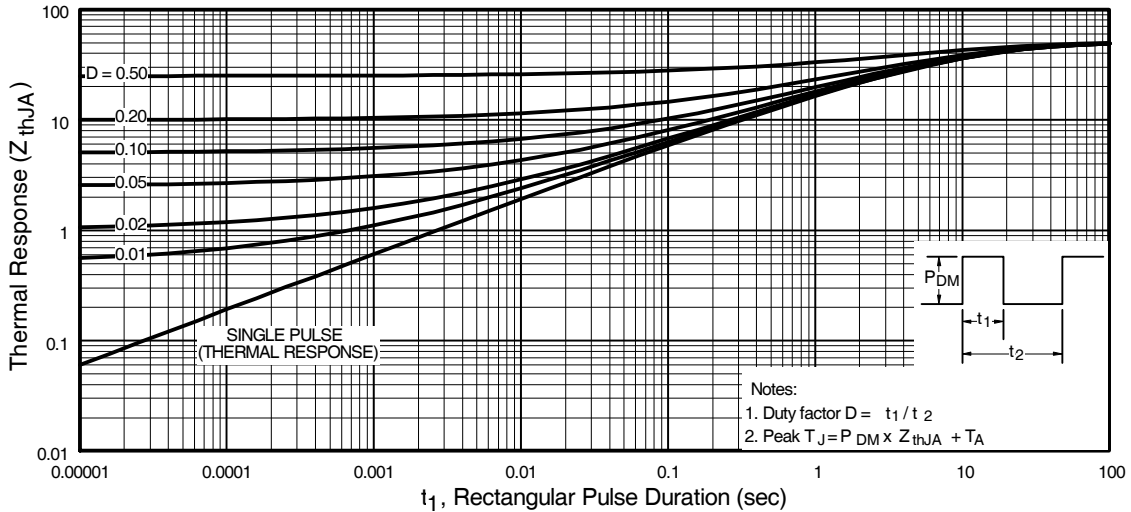

**Fig 11.** Maximum Effective Transient Thermal Impedance, Junction-to-Ambient

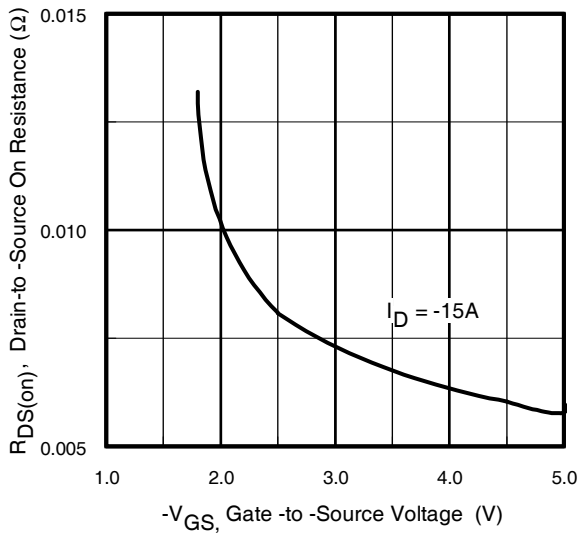

**Fig 12.** Typical On-Resistance Vs. Gate Voltage

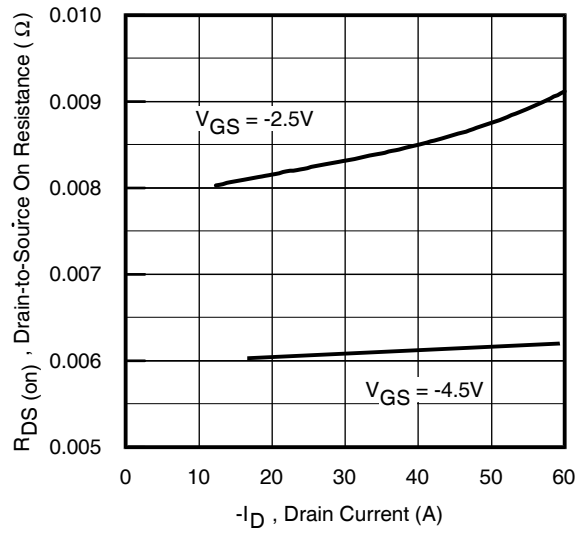

**Fig 13.** Typical On-Resistance Vs. Drain Current

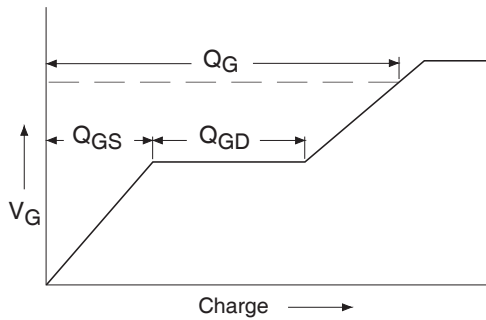

**Fig 14a.** Basic Gate Charge Waveform

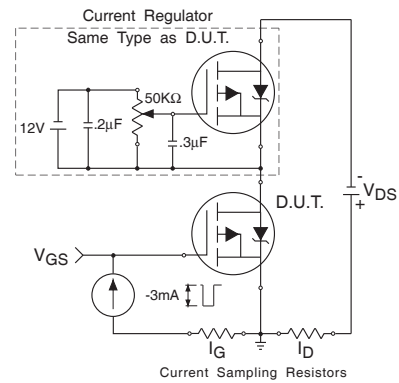

**Fig 14b.** Gate Charge Test Circuit

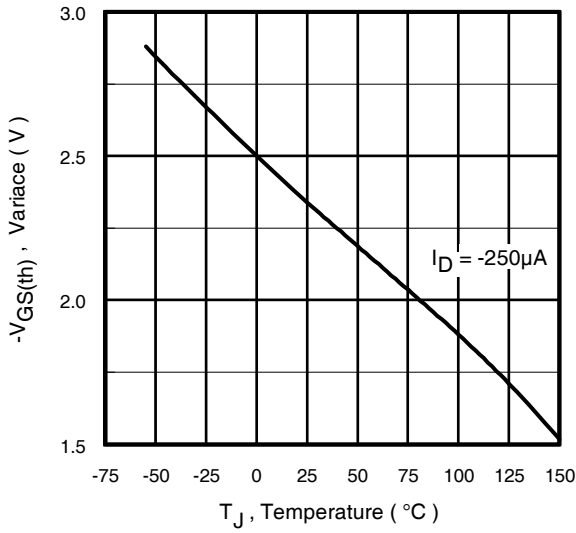

**Fig 15.** Typical V<sub>GS(th)</sub> Variance Vs. Junction Temperature

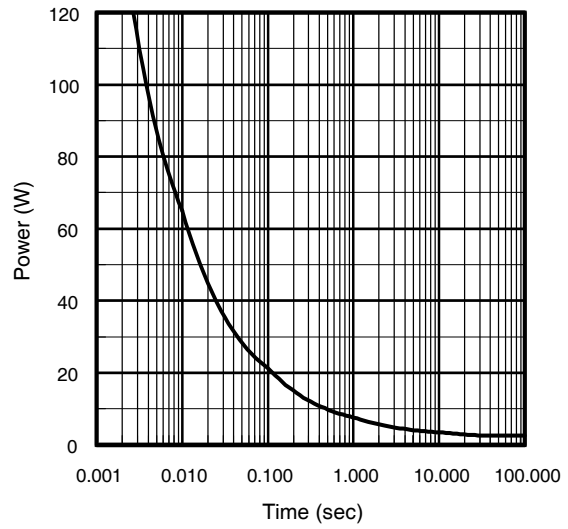

**Fig 16.** Typical Power Vs. Time

## SO-8 Package Outline

Dimensions are shown in millimeters (inches)

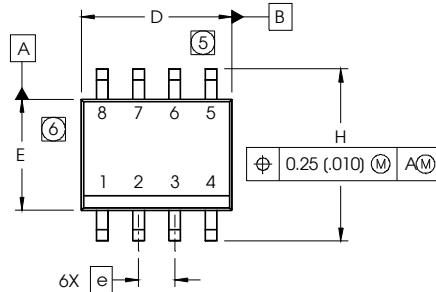

DIM	INCHES		MILLIMETERS	
	MIN	MAX	MIN	MAX
A	.0532	.0688	1.35	1.75
A1	.0040	.0098	0.10	0.25
b	.013	.020	0.33	0.51
c	.0075	.0098	0.19	0.25
D	.189	.1968	4.80	5.00
E	.1497	.1574	3.80	4.00
e	.050 BASIC		1.27 BASIC	
e1	.025 BASIC		0.635 BASIC	
H	.2284	.2440	5.80	6.20
K	.0099	.0196	0.25	0.50
L	.016	.050	0.40	1.27
y	0°	8°	0°	8°

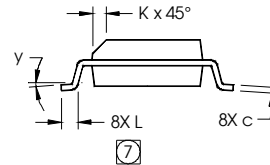
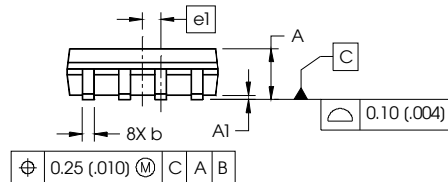

**NOTES:**

1. DIMENSIONING & TOLERANCING PER ASME Y14.5M-1994.
2. CONTROLLING DIMENSION: MILLIMETER
3. DIMENSIONS ARE SHOWN IN MILLIMETERS (INCHES).
4. OUTLINE CONFORMS TO JEDEC OUTLINE MS-012AA
- ⑤ DIMENSION DOES NOT INCLUDE MOLD PROTRUSIONS. MOLD PROTRUSIONS NOT TO EXCEED 0.15 (.006).
- ⑥ DIMENSION DOES NOT INCLUDE MOLD PROTRUSIONS. MOLD PROTRUSIONS NOT TO EXCEED 0.25 (.010).
- ⑦ DIMENSION IS THE LENGTH OF LEAD FOR SOLDERING TO A SUBSTRATE.

**FOOTPRINT**

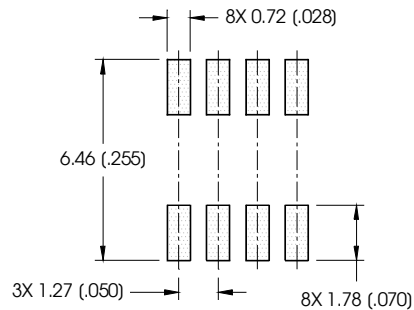

## SO-8 Part Marking

EXAMPLE: THIS IS AN IRF7101 (MOSFET)

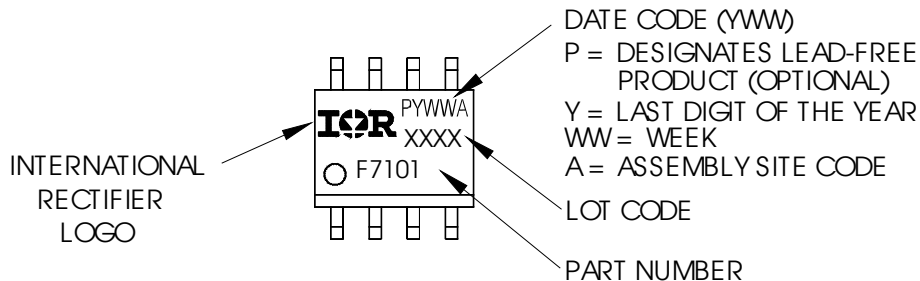

Note: For the most current drawing please refer to IR website at <http://www.irf.com/package/>



### SO-8 Tape and Reel

Dimensions are shown in millimeters (inches)

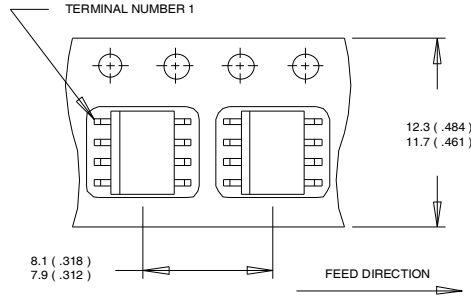

- NOTES:
1. CONTROLLING DIMENSION : MILLIMETER.
  2. ALL DIMENSIONS ARE SHOWN IN MILLIMETERS(INCHES).
  3. OUTLINE CONFORMS TO EIA-481 & EIA-541.

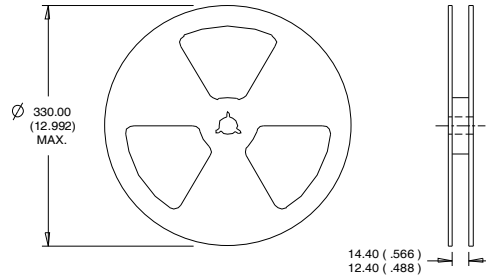

- NOTES :
1. CONTROLLING DIMENSION : MILLIMETER.
  2. OUTLINE CONFORMS TO EIA-481 & EIA-541.

Note: For the most current drawing please refer to IR website at <http://www.irf.com/package/>

#### Qualification information<sup>†</sup>

Qualification level	Industrial (per JEDEC JESD47F <sup>††</sup> guidelines)	
Moisture Sensitivity Level	SO-8	MSL1 (per JEDEC J-STD-020D <sup>††</sup> )
RoHS compliant	Yes	

<sup>†</sup> Qualification standards can be found at International Rectifier's web site: <http://www.irf.com/product-info/reliability>

<sup>††</sup> Applicable version of JEDEC standard at the time of product release

单击下面可查看定价，库存，交付和生命周期等信息

[>>Infineon Technologies\(英飞凌\)](#)