

# INN650DA04

## 650V GaN Enhancement-mode Power Transistor

### Features

- Enhancement mode transistor-Normally off power switch
- Ultra high switching frequency
- No reverse-recovery charge
- Low gate charge, low output charge
- Qualified for industrial applications according to JEDEC Standards
- ESD safeguard

### Benefits

- High efficiency power switching
- High power density
- Enables higher switching frequency
- System cost savings

### Applications

- AC-DC converters
- DC-DC converters
- Totem pole PFC
- Fast battery charging
- High density power conversion
- High efficiency power conversion

**Table 1 Key Performance Parameters at  $T_j = 25\text{ }^\circ\text{C}$**

Parameter	Value	Unit
$V_{DS,max}$	650	V
$R_{DS(on),max}$	400	$m\Omega$
$Q_{G,typ}$	0.9	nC
$I_{DS,Pulse}$	11	A
$Q_{OSS @ 400V}$	9	nC
$Q_{rr}$	0	nC

**Table 2 Ordering Information**

Type/Ordering Code	Package	Marking
INN650DA04	DFN 5X6	INN650DA04

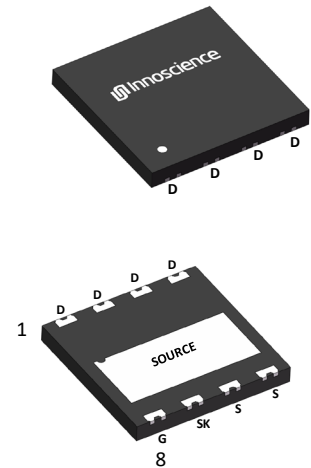

Gate	8
Drain	1,2,3,4
Kelvin Source	7
Source	5,6

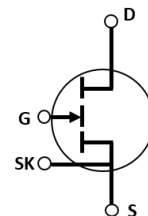

## Table of contents

Features.....	1
Benefits .....	1
Applications .....	1
Table of contents .....	2
1 <b>Maximum ratings</b> .....	3
2 <b>Thermal characteristics</b> .....	4
3 <b>Electrical characteristics</b> .....	5
4 <b>Electrical characteristics diagrams</b> .....	7
5 <b>Package outlines</b> .....	13
6 <b>Reel information</b> .....	14
7 <b>Revision history</b> .....	15

## 1 Maximum ratings

at  $T_j = 25\text{ }^\circ\text{C}$  unless otherwise specified.

Continuous application of maximum ratings can deteriorate transistor lifetime. For further information, contact Innoscence sales office.

**Table 3 Maximum ratings**

Parameter	Symbol	Values			Unit	Note/Test Condition
		Min.	Typ.	Max.		
Drain source voltage	$V_{DS,max}$	-	-	650	V	$V_{GS} = 0\text{ V}$ , $I_D = 10\text{ }\mu\text{A}$
Drain source voltage transient <sup>1</sup>	$V_{DS(transient)}$	-	-	750	V	$V_{GS} = 0\text{ V}$ , $V_{DS} = 750\text{ V}$
Continuous current, drain source	$I_D$	-	-	7	A	$T_c = 25\text{ }^\circ\text{C}$
Pulsed current, drain source <sup>2</sup>	$I_{D,pulse}$	-	-	11	A	$T_c = 25\text{ }^\circ\text{C}$ ; $V_G = 6\text{ V}$ ; See Figure 16;
Pulsed current, drain source <sup>2</sup>	$I_{D,Pulse}$	-	-	6	A	$T_c = 125\text{ }^\circ\text{C}$ ; $V_G = 6\text{ V}$ ; See Figure 17;
Gate source voltage, continuous <sup>3</sup>	$V_{GS}$	-1.4	-	+7	V	$T_j = -55\text{ }^\circ\text{C}$ to $150\text{ }^\circ\text{C}$
Gate source voltage, pulsed	$V_{GS,pulse}$	-20	-	+10	V	$T_j = -55\text{ }^\circ\text{C}$ to $150\text{ }^\circ\text{C}$ ; $t_{Pulse} = 50\text{ ns}$ , $f = 100\text{ kHz}$ open drain
Power dissipation	$P_{tot}$	-	-	39	W	$T_c = 25\text{ }^\circ\text{C}$
Operating temperature	$T_j$	-55	-	+150	$^\circ\text{C}$	
Storage temperature	$T_{stg}$	-55	-	+150	$^\circ\text{C}$	

1  $V_{DS(transient)}$  is intended for surge rating during non-repetitive events,  $t_{pulse} < 1\text{ }\mu\text{s}$

2 Pulse =  $300\text{ }\mu\text{s}$

3 The minimum  $V_{GS}$  is clamped by ESD protection circuit, as shown in Figure 10

## 2 Thermal characteristics

Table 4 Thermal characteristics

Parameter	Symbol	Values			Unit	Note/Test Condition
		Min.	Typ.	Max.		
Thermal resistance, junction-case	$R_{thJC}$	-	-	3.2	°C/W	
Reflow soldering temperature	$T_{sold}$	-	-	260	°C	MSL3

### 3 Electrical characteristics

at  $T_j = 25\text{ }^\circ\text{C}$ , unless specified otherwise

**Table 5 Static characteristics**

Parameter	Symbol	Values			Unit	Note/Test Condition
		Min.	Typ.	Max.		
Gate threshold voltage	$V_{GS(TH)}$	1.2	1.6	2.2	V	$I_D = 5.2\text{ mA}; V_{DS} = V_{GS}; T_j = 25\text{ }^\circ\text{C}$
		-	1.7	-		$I_D = 5.2\text{ mA}; V_{DS} = V_{GS}; T_j = 125\text{ }^\circ\text{C}$
Drain-source leakage current	$I_{DSS}$	-	0.4	10	$\mu\text{A}$	$V_{DS} = 650\text{ V}; V_{GS} = 0\text{ V}; T_j = 25\text{ }^\circ\text{C}$
		-	5	80		$V_{DS} = 650\text{ V}; V_{GS} = 0\text{ V}; T_j = 150\text{ }^\circ\text{C}$
Gate-source leakage current	$I_{GSS}$	-	4	-	$\mu\text{A}$	$V_{GS} = 6\text{ V}; V_{DS} = 0\text{ V}$
Drain-source on-state resistance	$R_{DS(on)}$	-	368	400	m $\Omega$	$V_{GS} = 6\text{ V}; I_D = 2\text{ A}; T_j = 25\text{ }^\circ\text{C}$
		-	750	-		$V_{GS} = 6\text{ V}; I_D = 2\text{ A}; T_j = 150\text{ }^\circ\text{C}$
Gate resistance	$R_G$	-	3	-	$\Omega$	$F = 5\text{ MHz}; \text{open drain}$

**Table 6 Dynamic characteristics**

Parameter	Symbol	Values			Unit	Note/Test Condition
		Min.	Typ.	Max.		
Input capacitance	$C_{iss}$	-	34	-	pF	$V_{GS} = 0\text{ V}; V_{DS} = 400\text{ V}; f = 100\text{ kHz}$
Output capacitance	$C_{oss}$	-	9	-	pF	$V_{GS} = 0\text{ V}; V_{DS} = 400\text{ V}; f = 100\text{ kHz}$
Reverse transfer capacitance	$C_{riss}$	-	0.4	-	pF	$V_{GS} = 0\text{ V}; V_{DS} = 400\text{ V}; f = 100\text{ kHz}$
Effective output capacitance, energy related <sup>1</sup>	$C_{o(er)}$	-	13	-	pF	$V_{GS} = 0\text{ V}; V_{DS} = 0\text{ to }400\text{ V}$
Effective output capacitance, time related <sup>2</sup>	$C_{o(tr)}$	-	20	-	pF	$V_{GS} = 0\text{ V}; V_{DS} = 0\text{ to }400\text{ V}$
Output Charge	$Q_{oss}$	-	9	-	nC	$V_{GS} = 0\text{ V}; V_{DS} = 0\text{ to }400\text{ V}$

<sup>1</sup>  $C_{o(er)}$  is the fixed capacitance that gives the same stored energy as  $C_{oss}$  while  $V_{DS}$  is rising from 0 to 400 V

<sup>2</sup>  $C_{o(tr)}$  is the fixed capacitance that gives the same charging time as  $C_{oss}$  while  $V_{DS}$  is rising from 0 to 400 V

**Table 7 Gate charge characteristics**

Parameter	Symbol	Values			Unit	Note/Test Condition
		Min.	Typ.	Max.		
Gate charge	$Q_G$	-	0.9	-	nC	$V_{GS} = 0 \text{ to } 6 \text{ V}; V_{DS} = 400 \text{ V}; I_D = 2 \text{ A}$
Gate-source charge	$Q_{GS}$	-	0.1	-	nC	
Gate-drain charge	$Q_{GD}$	-	0.3	-	nC	
Gate Plateau Voltage	$V_{Plat}$	-	2.7	-	V	$V_{DS} = 400 \text{ V}; I_D = 2 \text{ A}$

**Table 8 Reverse conduction characteristics**

Parameter	Symbol	Values			Unit	Note/Test Condition
		Min.	Typ.	Max.		
Source-Drain reverse voltage	$V_{SD}$	-	3	-	V	$V_{GS} = 0 \text{ V}; I_{SD} = 2 \text{ A}$
Pulsed current, reverse	$I_{S,pulse}$	-	-	11	A	$V_G = -4 \text{ V}$
Reverse recovery charge	$Q_{rr}$	-	0	-	nC	$I_{SD} = 2 \text{ A}; V_{DS} = 400 \text{ V}$
Reverse recovery time	$t_{rr}$	-	0	-	ns	
Peak reverse recovery current	$I_{rrm}$	-	0	-	A	

## 4 Electrical characteristics diagrams

at  $T_j = 25\text{ }^\circ\text{C}$ , unless specified otherwise

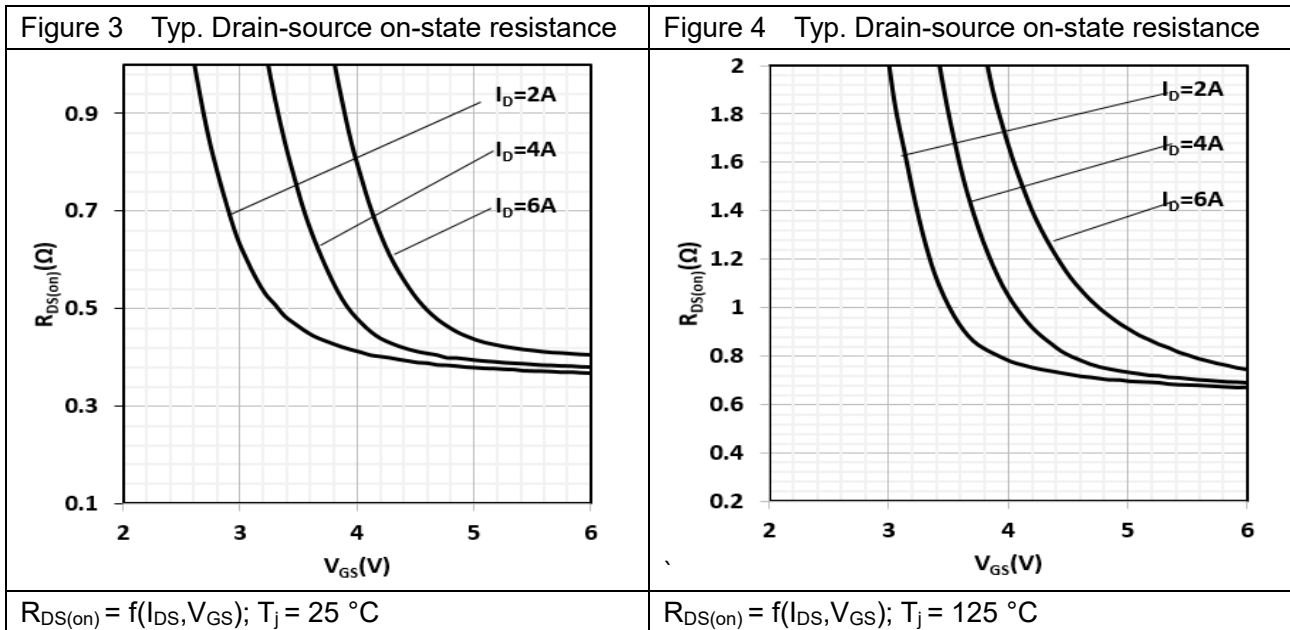
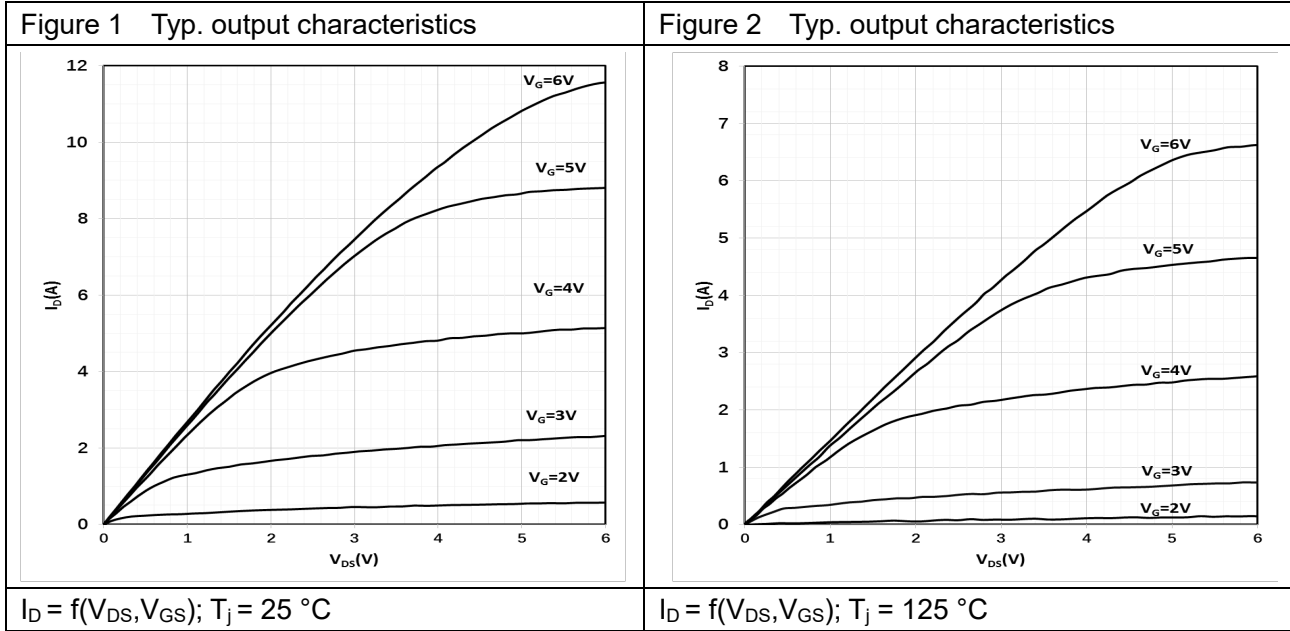
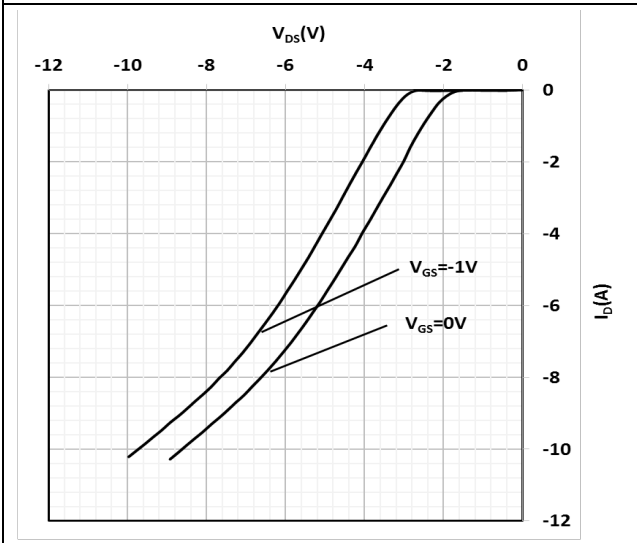
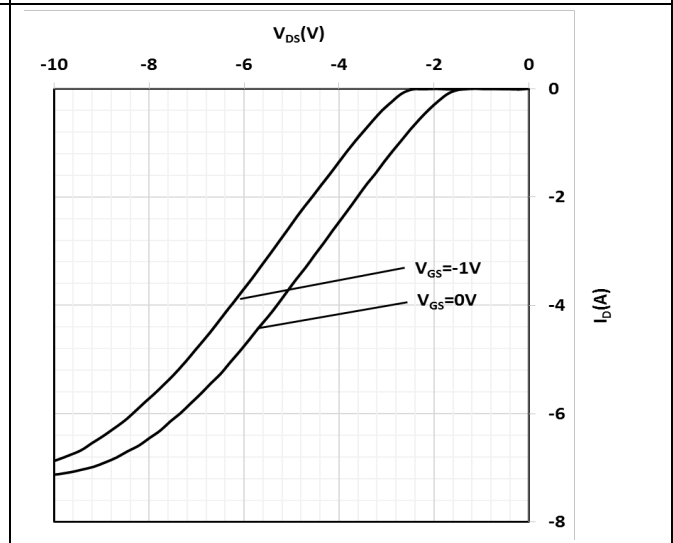

Figure 5 Typ. channel reverse characteristics



$I_D = f(V_{DS}, V_{GS}); T_j = 25\text{ }^\circ\text{C}$

Figure 6 Typ. channel reverse characteristics



$I_D = f(V_{DS}, V_{GS}); T_j = 125\text{ }^\circ\text{C}$

Figure 7 Typ. channel reverse characteristics

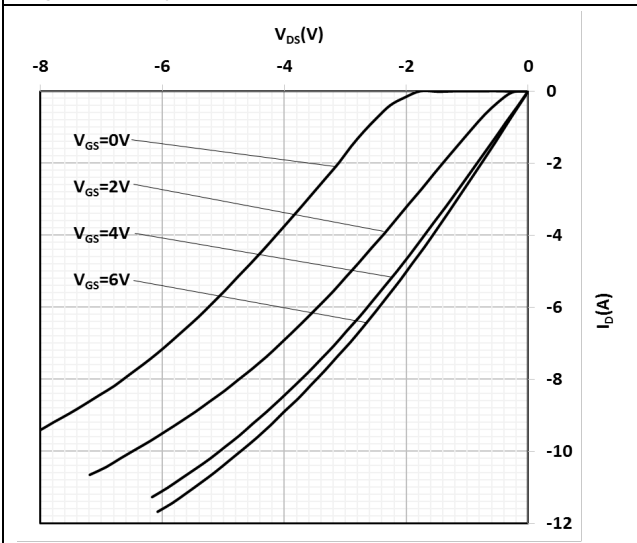

$I_D = f(V_{DS}, V_{GS}); T_j = 25\text{ }^\circ\text{C}$

Figure 8 Typ. channel reverse characteristics

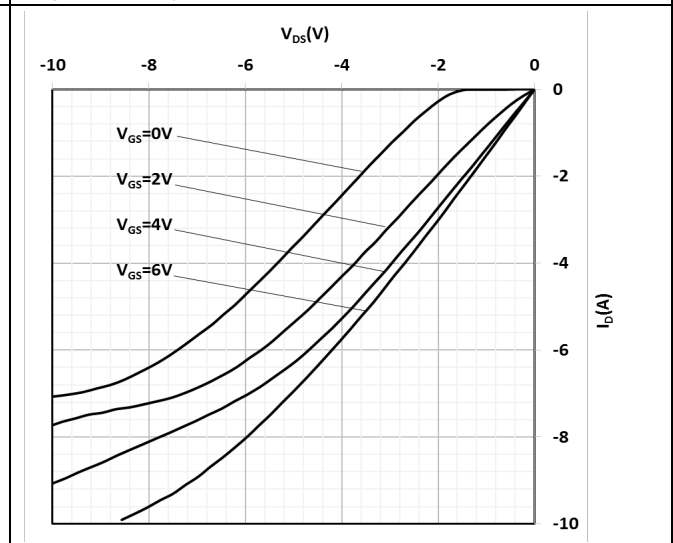

$I_D = f(V_{DS}, V_{GS}); T_j = 125\text{ }^\circ\text{C}$



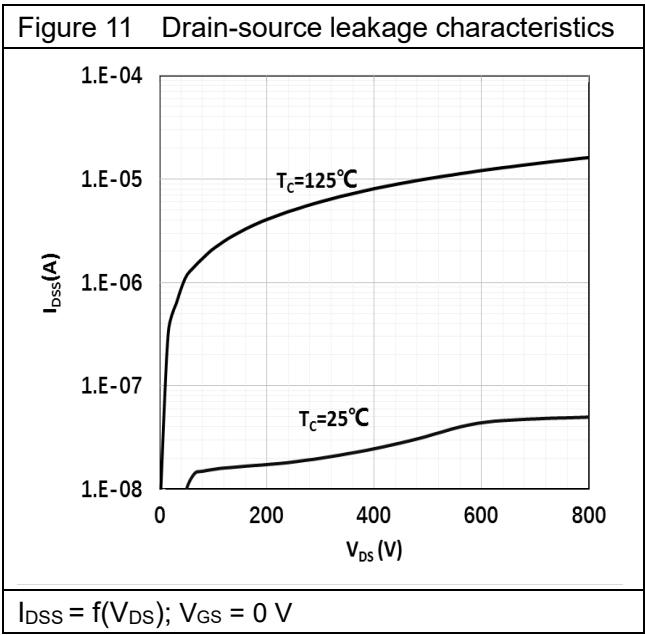
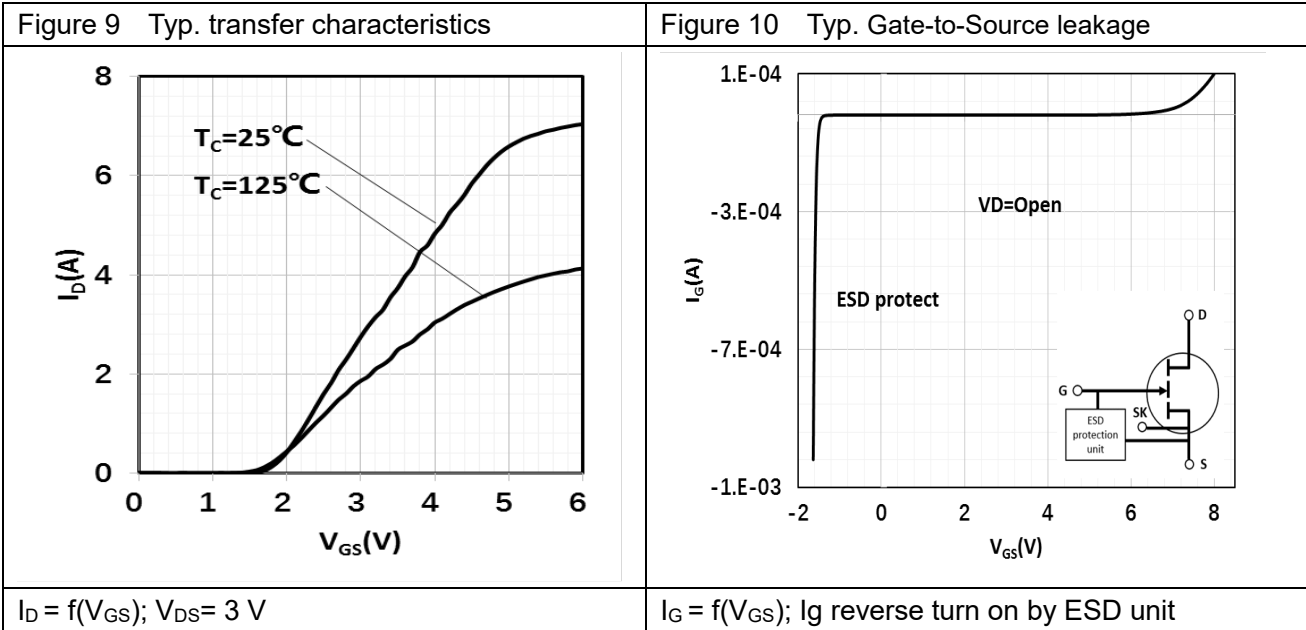

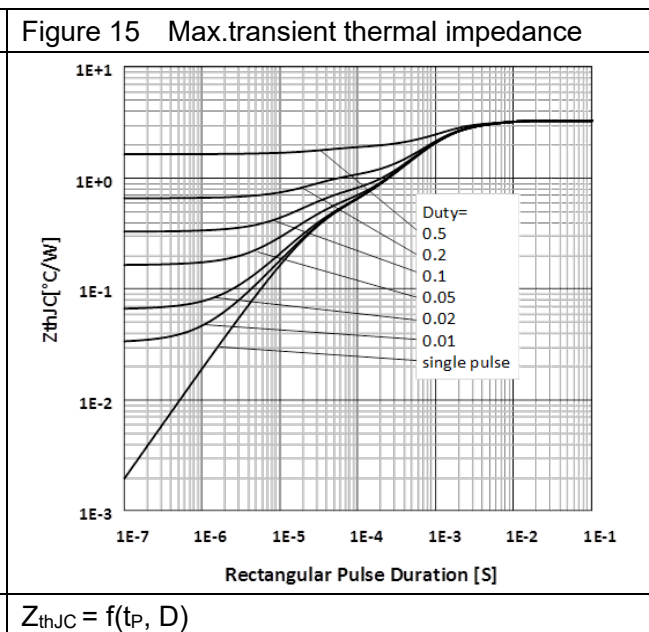
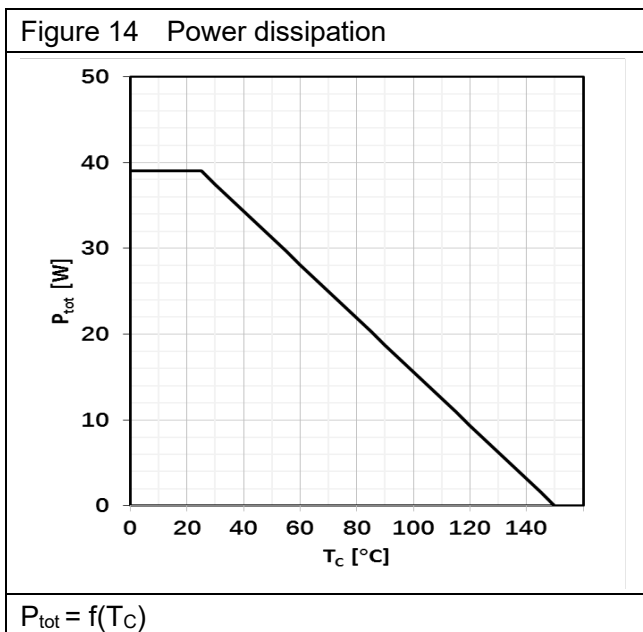
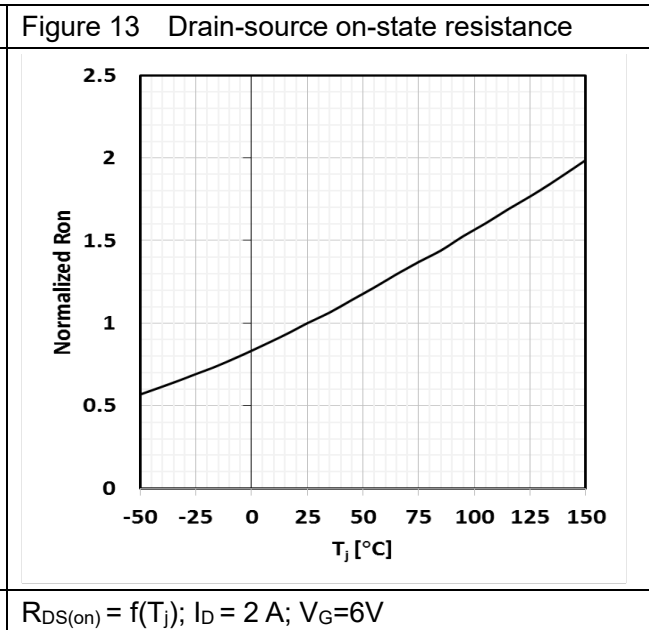
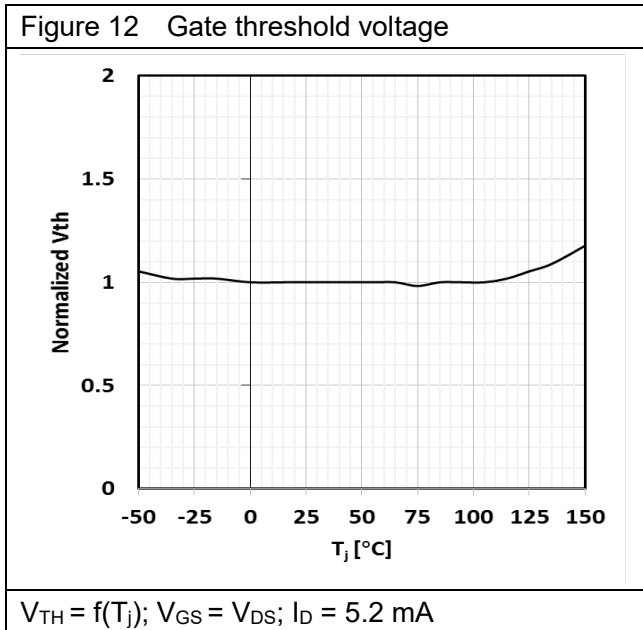

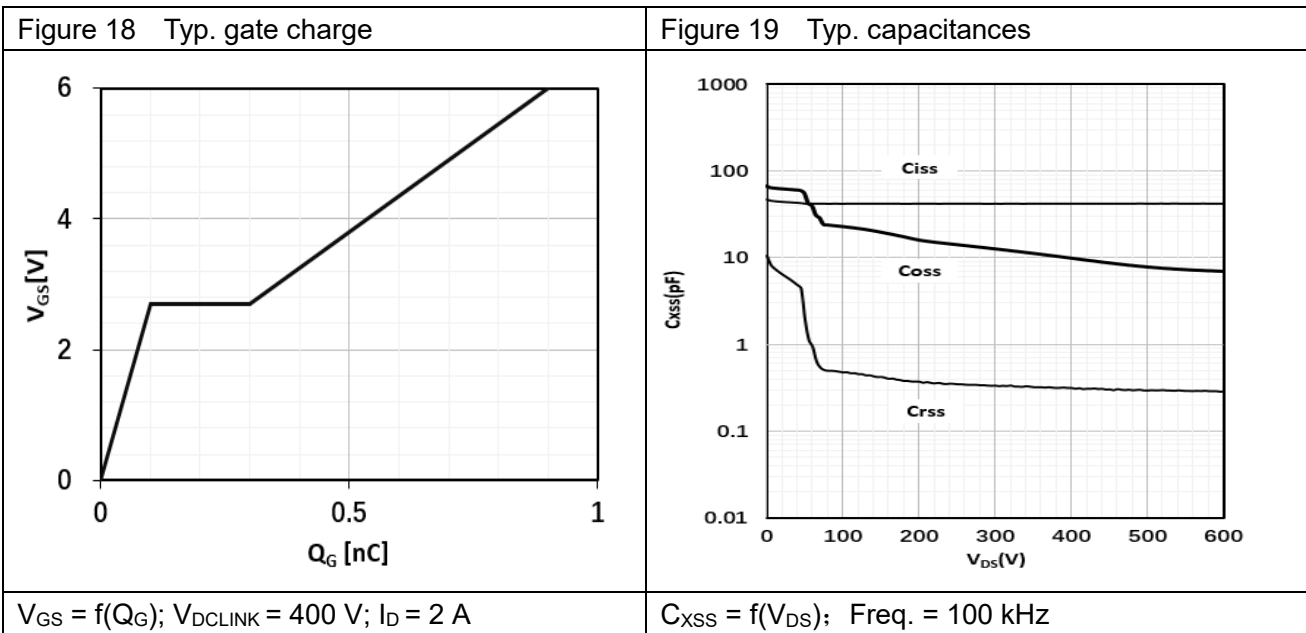
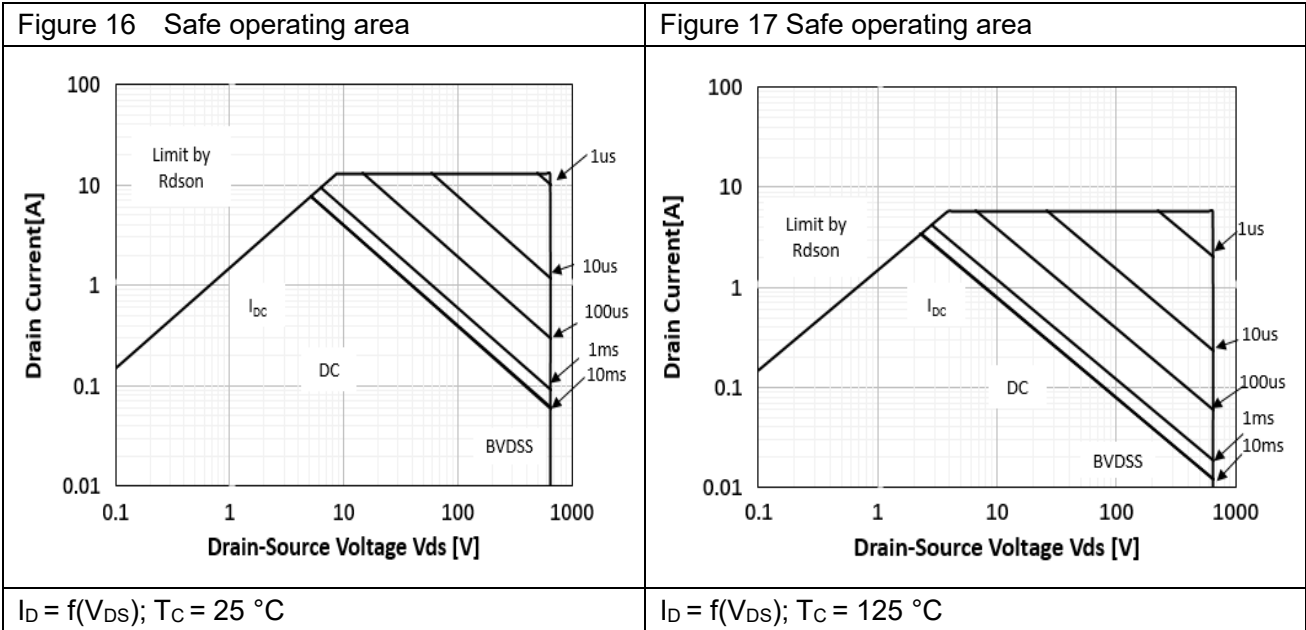
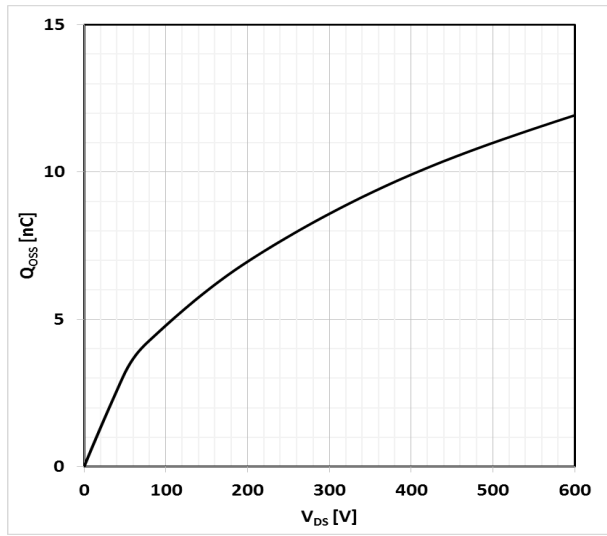
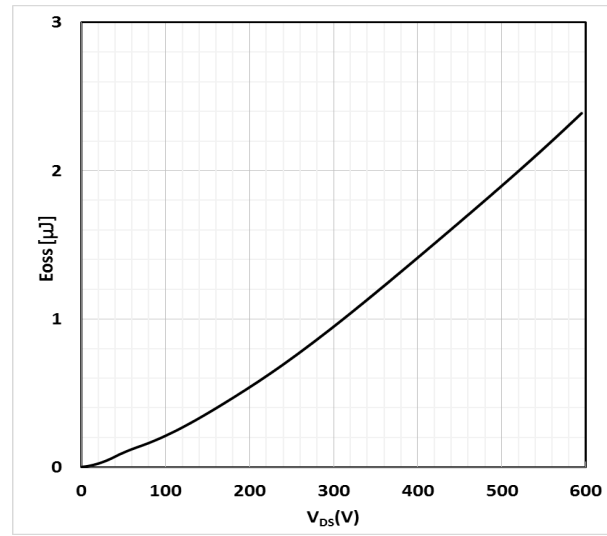

Figure 20 Typ. output charge



$Q_{OSS} = f(V_{DS})$ ; Freq. = 100 kHz

Figure 21 Typ. C<sub>OSS</sub> stored Energy



$E_{OSS} = f(V_{DS})$ ; Freq. = 100 kHz

## 5 Package outlines

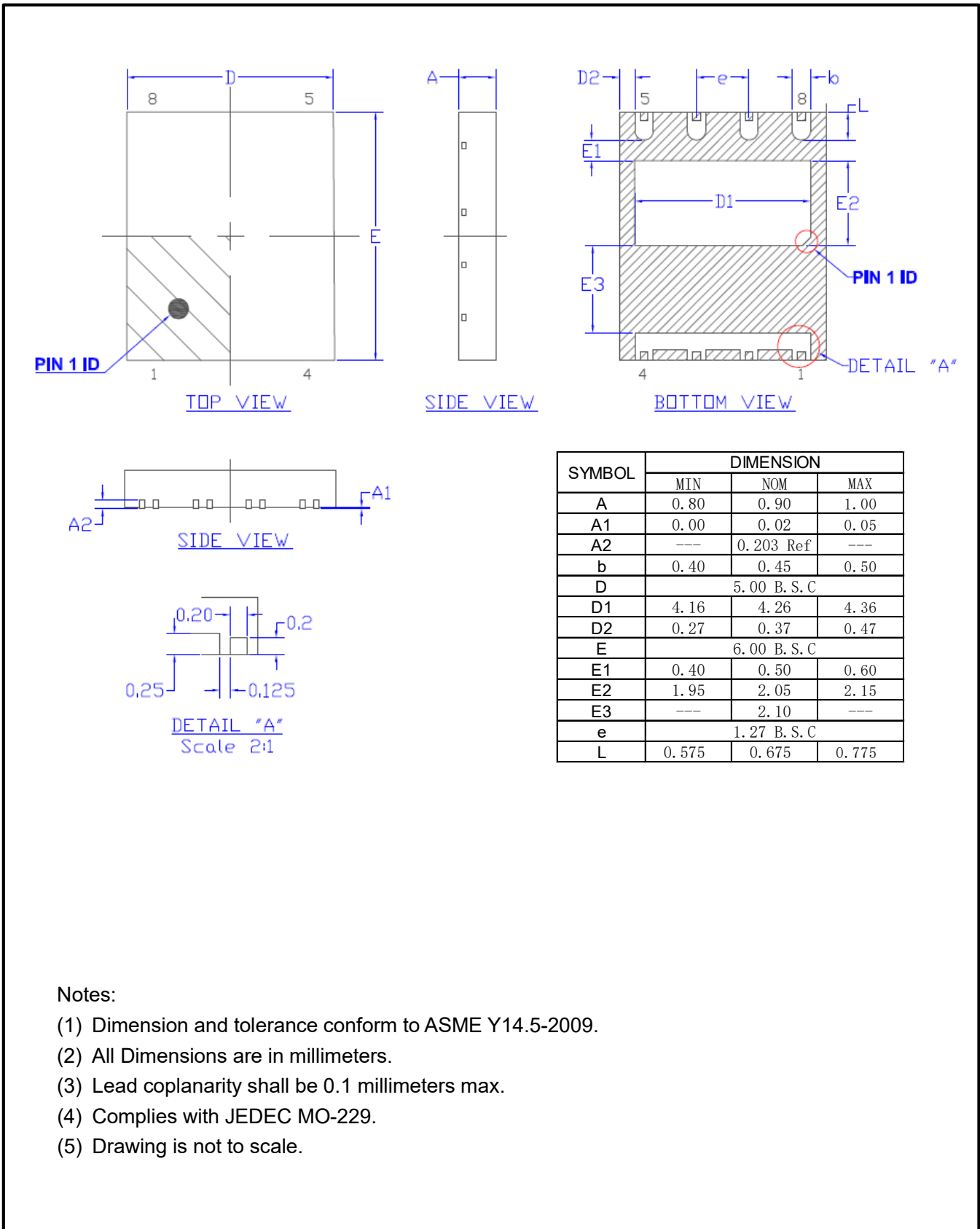

**Notes:**

- (1) Dimension and tolerance conform to ASME Y14.5-2009.
- (2) All Dimensions are in millimeters.
- (3) Lead coplanarity shall be 0.1 millimeters max.
- (4) Complies with JEDEC MO-229.
- (5) Drawing is not to scale.

## 6 Reel information

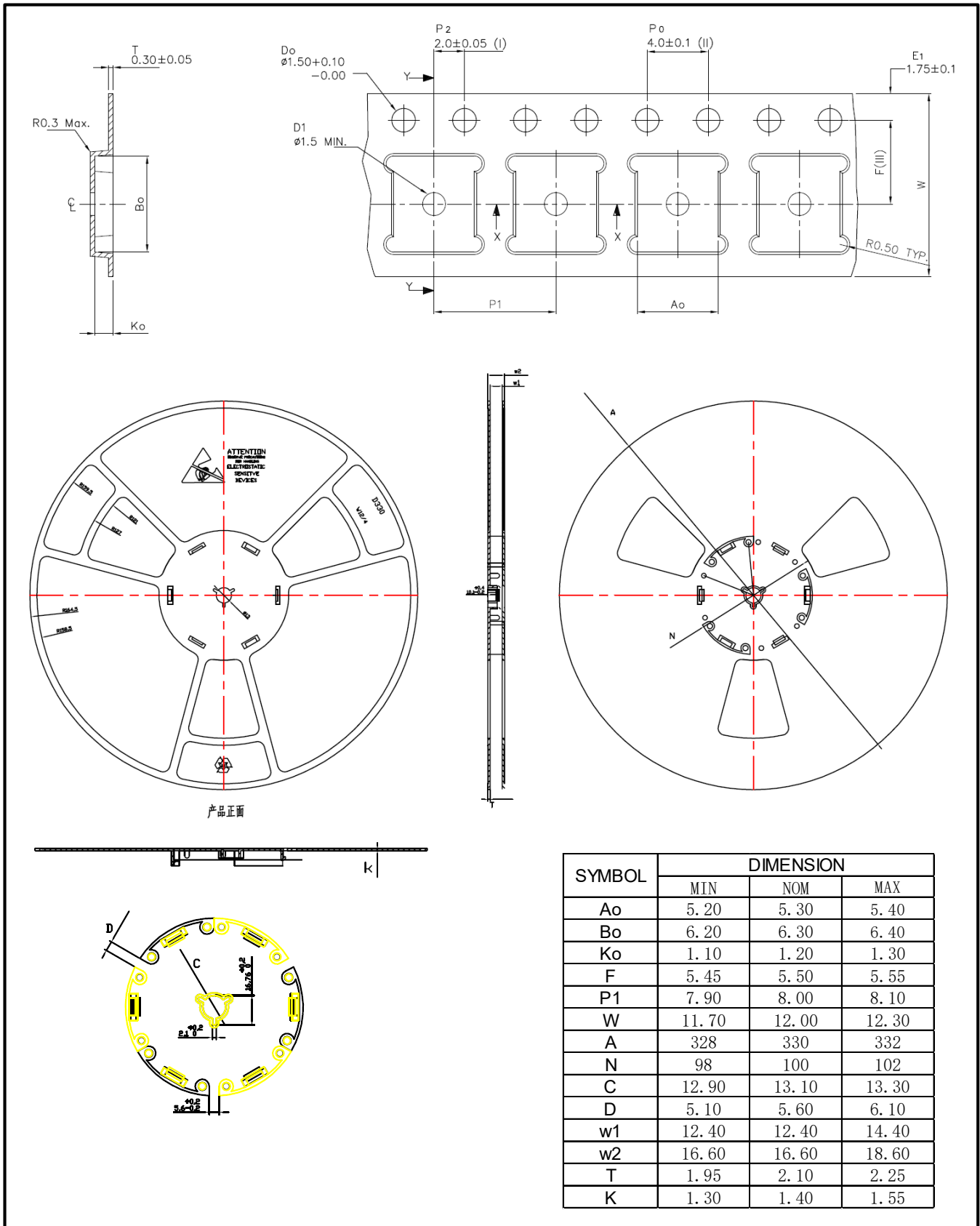

## 7 Revision history

### Major changes since the last revision

Revision	Date	Description of changes
1.0	2021-1-28	Preliminary version release

单击下面可查看定价，库存，交付和生命周期等信息

[>>Innoscience](#)