

IV2Q12040D7Z – 1200V 40mΩ Gen2 Automotive SiC MOSFET

Features

- 2nd Generation SiC MOSFET Technology with +15V~+18V gate drive
- High blocking voltage with low on-resistance
- High speed switching with low capacitance
- 175°C operating junction temperature capability
- Ultra fast and robust intrinsic body diode
- Kelvin gate input easing driver circuit design
- AEC-Q101 qualified

Applications

- EV chargers and OBCs
- Solar boosters
- Automotive compressor inverters
- AC/DC power supplies

Outline:



TO263-7

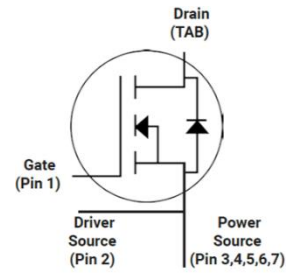

Marking Diagram:

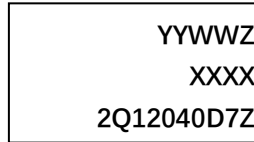

2Q12040D7Z = Specific Device Code
 YY = Year
 WW = Work Week
 Z = Assembly Location
 XXXX = Lot Traceability

Absolute Maximum Ratings (T_c=25°C unless otherwise specified)

Symbol	Parameter	Value	Unit	Test Conditions	Note
V _{DS}	Drain-Source voltage	1200	V	V _{GS} =0V, I _D =100μA	
V _{GSmax} (Transient)	Maximum transient voltage	-10 to 23	V	Duty cycle<1%, and pulse width<200ns	
V _{GSon}	Recommended turn-on voltage	15 to 18	V		
V _{GSoff}	Recommended turn-off voltage	-5 to -2	V	Typical -3.5V	
I _D	Drain current (continuous)	65	A	V _{GS} =18V, T _c =25°C	Fig. 23
		48	A	V _{GS} =18V, T _c =100°C	
I _{DM}	Drain current (pulsed)	162	A	Pulse width limited by SOA and dynamic R _{θ(j-c)}	Fig. 25,26
I _{SM}	Body diode current (pulsed)	162	A	Pulse width limited by SOA and dynamic R _{θ(j-c)}	Fig. 25,26
P _{TOT}	Total power dissipation	417	W	T _c =25°C	Fig. 24
T _{stg}	Storage temperature range	-55 to 175	°C		
T _J	Operating junction temperature	-55 to 175	°C		
T _L	Solder Temperature	260	°C	wave soldering only allowed at leads, 1.6mm from case for 10 s	

Thermal Data

Symbol	Parameter	Value	Unit	Note
R _{θ(j-c)}	Thermal Resistance from Junction to Case	0.36	°C/W	Fig. 25

Electrical Characteristics ($T_c=25^\circ\text{C}$ unless otherwise specified)

Symbol	Parameter	Value			Unit	Test Conditions	Note
		Min.	Typ.	Max.			
I_{DSS}	Zero gate voltage drain current		5	100	μA	$V_{DS}=1200\text{V}, V_{GS}=0\text{V}$	
I_{GSS}	Gate leakage current			± 100	nA	$V_{DS}=0\text{V}, V_{GS}=-5\sim 20\text{V}$	
V_{TH}	Gate threshold voltage	1.8	2.8	4.5	V	$V_{GS}=V_{DS}, I_D=9\text{mA}$	Fig. 8, 9
			2.1			$V_{GS}=V_{DS}, I_D=9\text{mA}$ @ $T_J=175^\circ\text{C}$	
R_{ON}	Static drain-source on-resistance		40	52	$\text{m}\Omega$	$V_{GS}=18\text{V}, I_D=20\text{A}$ @ $T_J=25^\circ\text{C}$	Fig. 4, 5, 6, 7
			75		$\text{m}\Omega$	$V_{GS}=18\text{V}, I_D=20\text{A}$ @ $T_J=175^\circ\text{C}$	
R_{ON}			50	70	$\text{m}\Omega$	$V_{GS}=15\text{V}, I_D=20\text{A}$ @ $T_J=25^\circ\text{C}$	
			80		$\text{m}\Omega$	$V_{GS}=15\text{V}, I_D=20\text{A}$ @ $T_J=175^\circ\text{C}$	
C_{iss}	Input capacitance		2160		pF	$V_{DS}=800\text{V}, V_{GS}=0\text{V},$ $f=1\text{MHz}, V_{AC}=25\text{mV}$	Fig. 16
C_{oss}	Output capacitance		100		pF		
C_{rss}	Reverse transfer capacitance		5.8		pF		
E_{oss}	C_{oss} stored energy		40		μJ		Fig. 17
Q_g	Total gate charge		110		nC	$V_{DS}=800\text{V}, I_D=30\text{A},$ $V_{GS}=-3$ to 18V	Fig. 18
Q_{gs}	Gate-source charge		25		nC		
Q_{gd}	Gate-drain charge		59		nC		
R_g	Gate input resistance		2.1		Ω	$f=1\text{MHz}$	
E_{ON}	Turn-on switching energy		571.7		μJ	$V_{DS}=800\text{V}, I_D=30\text{A},$ $V_{GS}=-3.5$ to $18\text{V},$ $R_{G(\text{ext})}=3.3\Omega,$ $L=200\mu\text{H}$ $T_J=25^\circ\text{C}$	Fig. 19, 20
E_{OFF}	Turn-off switching energy		62.2		μJ		
$t_{d(\text{on})}$	Turn-on delay time		11.0		ns		
t_r	Rise time		19.6				
$t_{d(\text{off})}$	Turn-off delay time		20.8				
t_f	Fall time		11.6				
E_{ON}	Turn-on switching energy		872.1		μJ	$V_{DS}=800\text{V}, I_D=30\text{A},$ $V_{GS}=-3.5$ to $18\text{V},$ $R_{G(\text{ext})}=3.3\Omega, L=200\mu\text{H}$ $T_J=175^\circ\text{C}$	Fig. 22
E_{OFF}	Turn-off switching energy		56.9		μJ		

Reverse Diode Characteristics ($T_c=25^\circ\text{C}$ unless otherwise specified)

Symbol	Parameter	Value			Unit	Test Conditions	Note
		Min.	Typ.	Max.			
V_{SD}	Diode forward voltage		4.1		V	$I_{SD}=20\text{A}, V_{GS}=0\text{V}$	Fig. 10, 11, 12
			4.0		V	$I_{SD}=20\text{A}, V_{GS}=0\text{V}, T_J=175^\circ\text{C}$	
I_S	Diode forward current (continuous)			63	A	$V_{GS}=-2\text{V}, T_c=25^\circ\text{C}$	
				36	A	$V_{GS}=-2\text{V}, T_c=100^\circ\text{C}$	
t_{rr}	Reverse recovery time		47		ns	$V_{GS}=-3.5\text{V}/+18\text{V}, I_{SD}=30\text{A}, V_R=800\text{V}, R_{G(\text{ext})}=13\Omega, L=200\mu\text{H}, di/dt=3000\text{A}/\mu\text{s}$	
Q_{rr}	Reverse recovery charge		203		nC		
I_{RRM}	Peak reverse recovery current		16.4		A		

Typical Performance (curves)

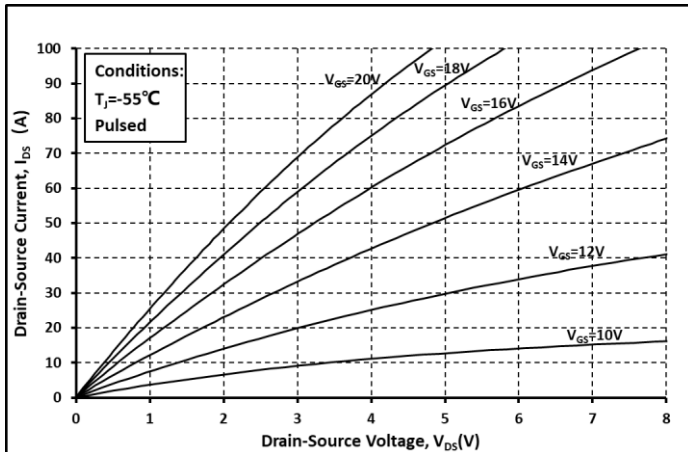

Fig. 1 Output Curve @ $T_J=-55^\circ\text{C}$

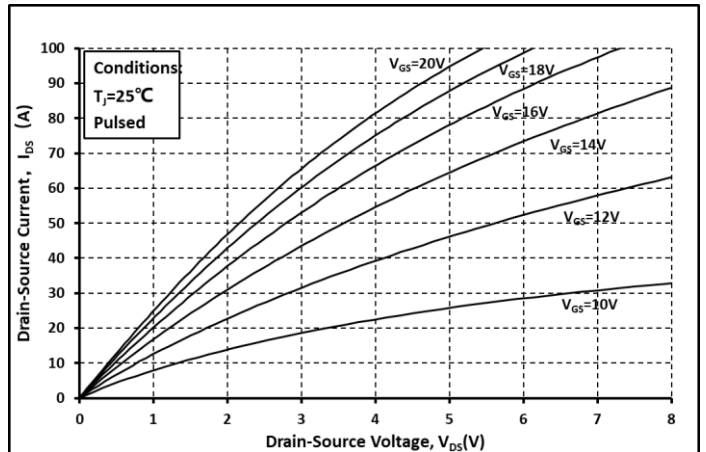

Fig. 2 Output Curve @ $T_J=25^\circ\text{C}$

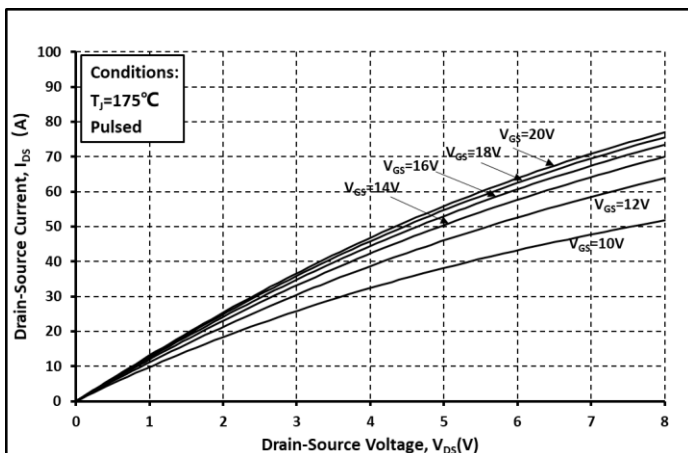

Fig. 3 Output Curve @ $T_J=175^\circ\text{C}$

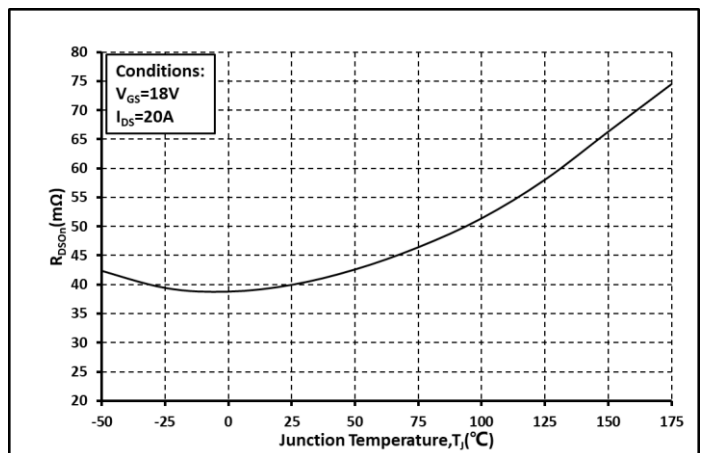

Fig. 4 R_{on} vs. Temperature

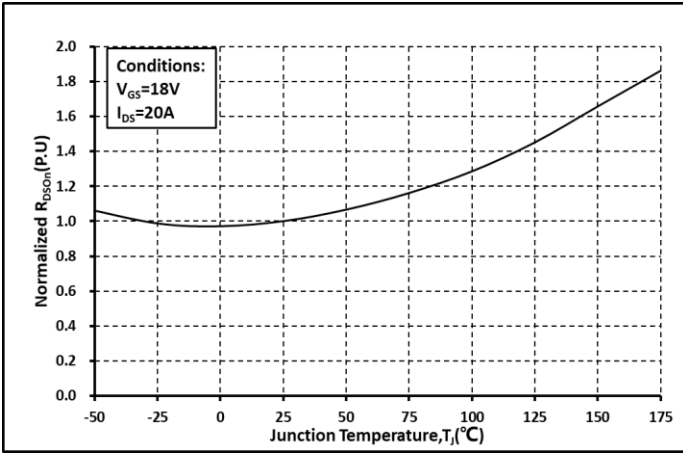

Fig. 5 Normalized Ron vs. Temperature

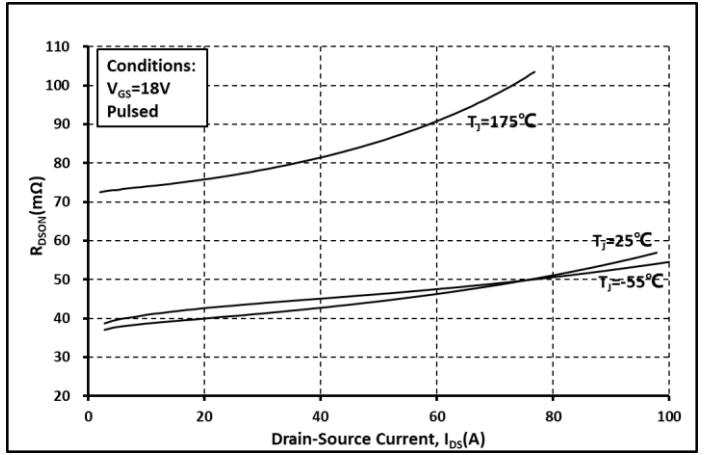

Fig. 6 Ron vs. Ids @ Various Temperature

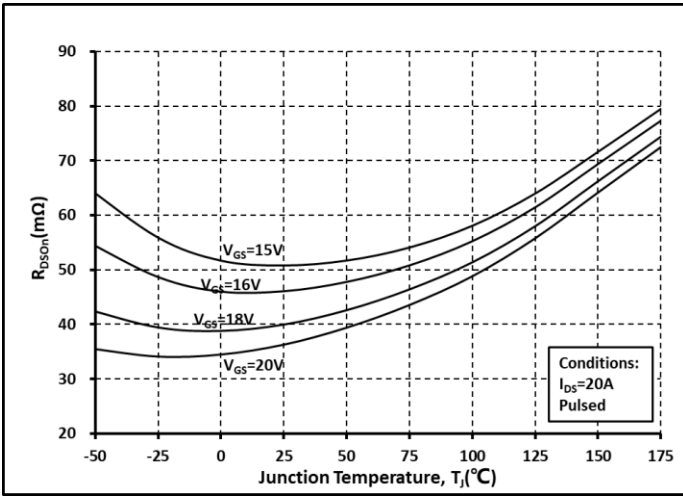

Fig. 7 Ron vs. Temperature @ Various Vgs

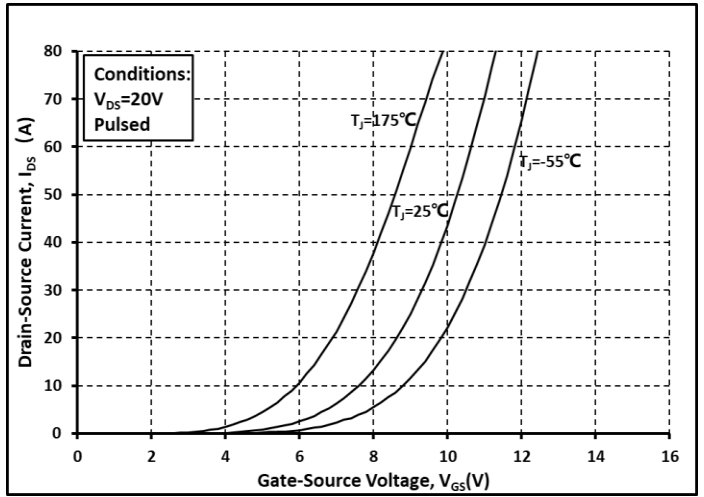

Fig. 8 Transfer Curves @ Various Temperature

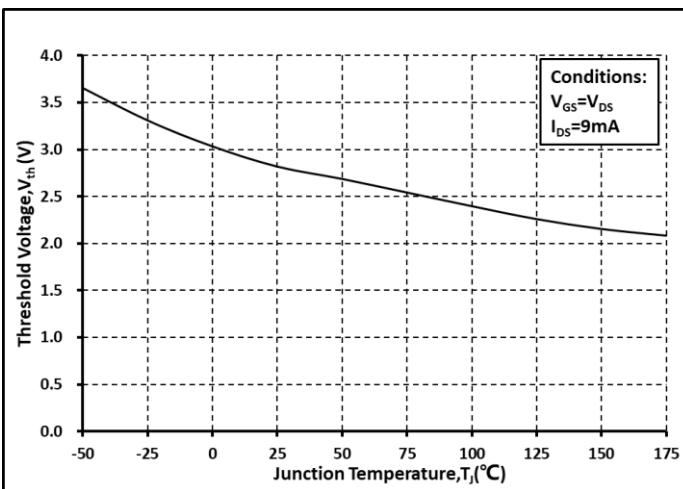

Fig. 9 Threshold Voltage vs. Temperature

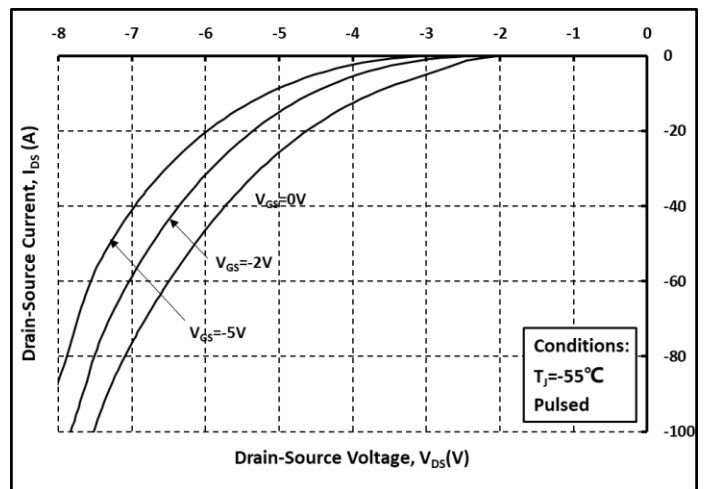

Fig. 10 Body Diode curves @ Tj=-55°C

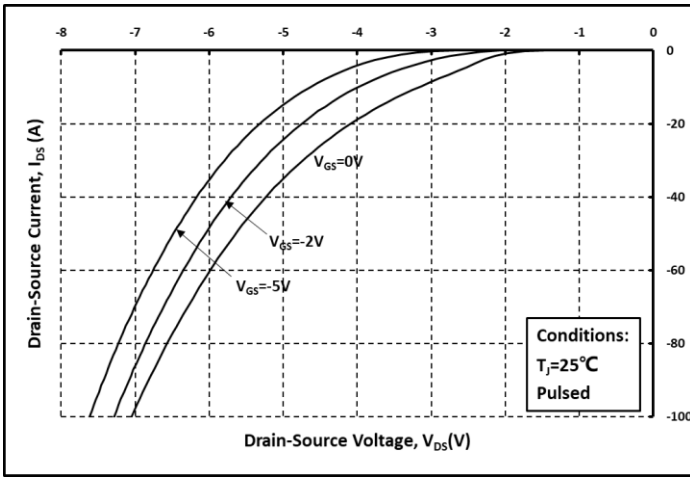

Fig. 11 Body Diode curves @ $T_j=25^\circ\text{C}$

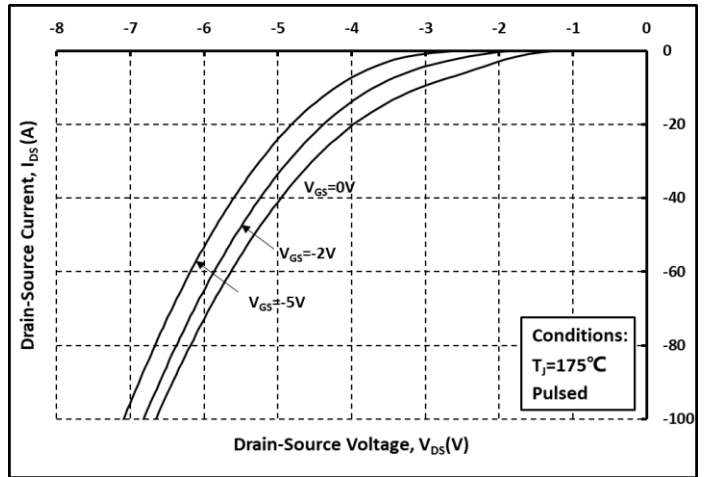

Fig. 12 Body Diode curves @ $T_j=175^\circ\text{C}$

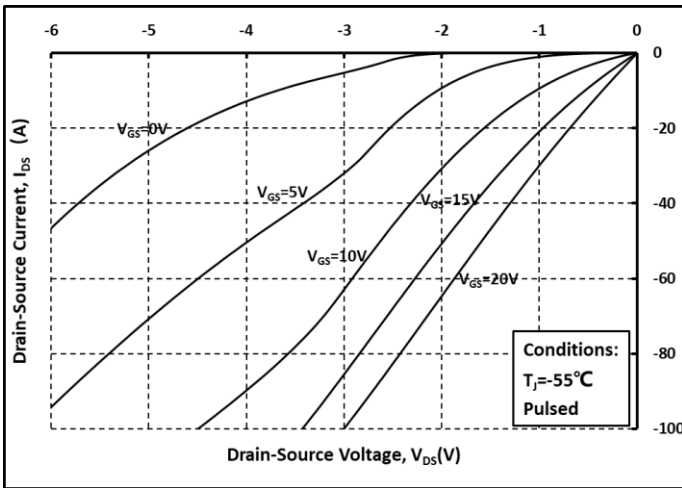

Fig. 13 3rd Quadrant curves @ $T_j=-55^\circ\text{C}$

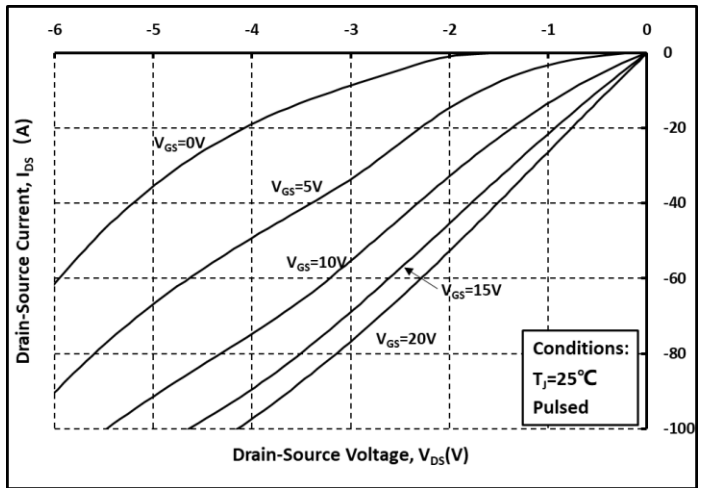

Fig. 14 3rd Quadrant curves @ $T_j=25^\circ\text{C}$

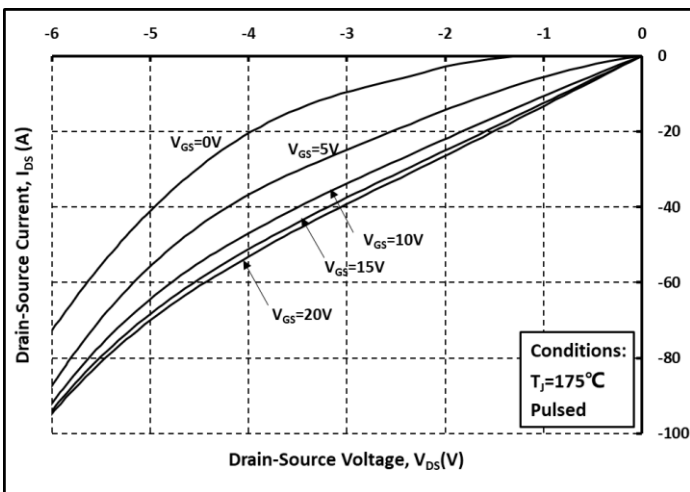

Fig. 15 3rd Quadrant curves @ $T_j=175^\circ\text{C}$

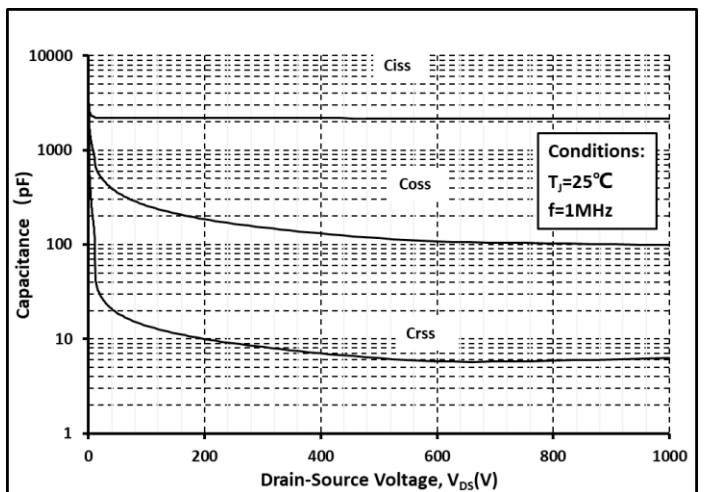

Fig. 16 Capacitance vs. V_{DS}

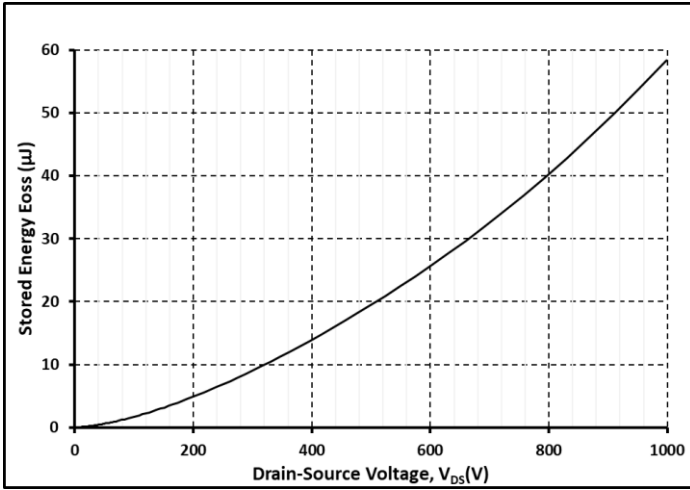

Fig. 17 Output Capacitor Stored Energy

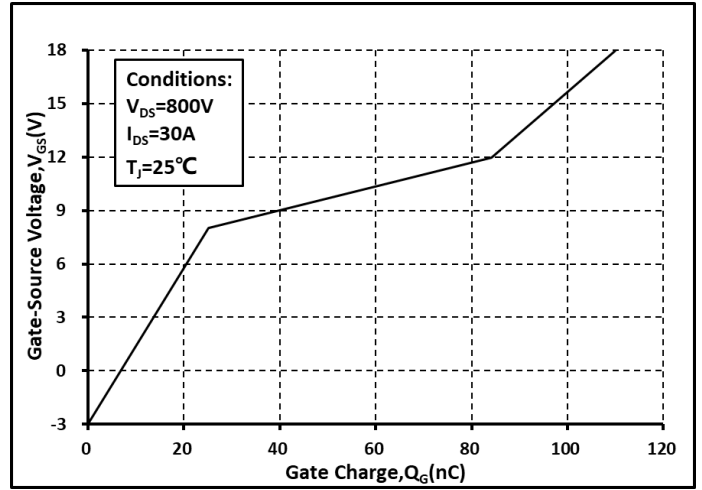

Fig. 18 Gate Charge Characteristics

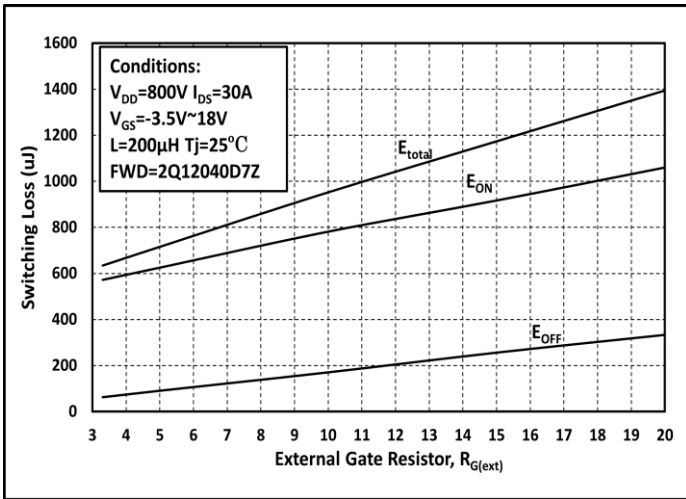

Fig. 19 Switching Energy vs. $R_{G(ext)}$

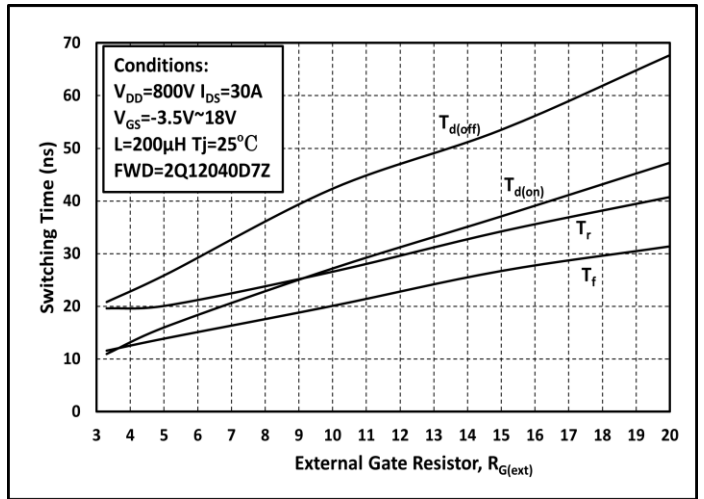

Fig. 20 Switching Times vs. $R_{G(ext)}$

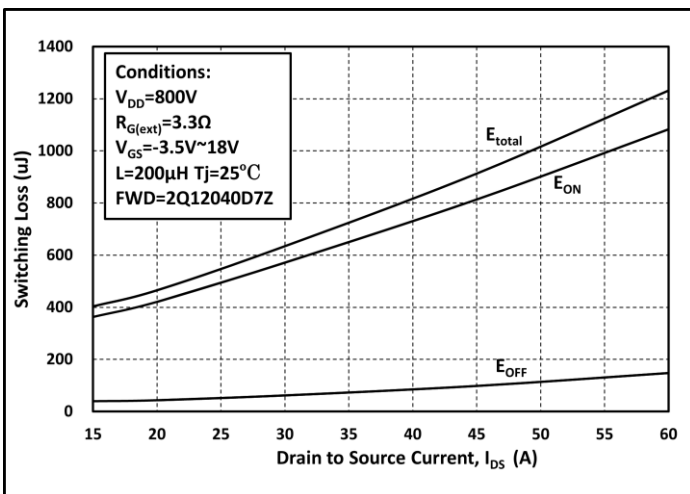

Fig. 21 Switching Energy vs. I_{DS}

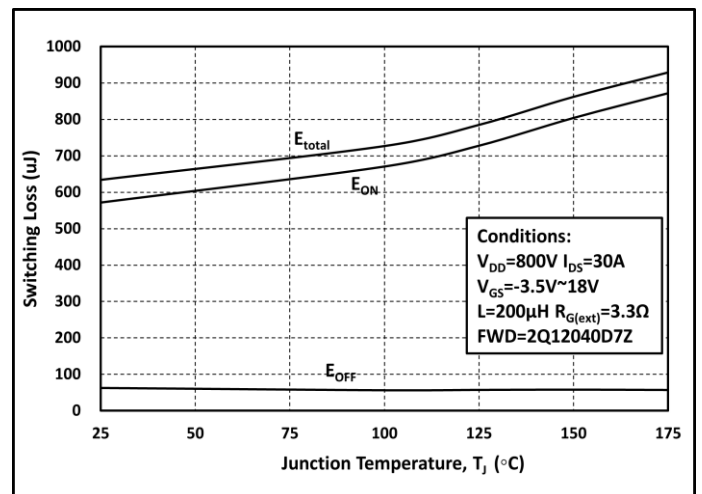

Fig. 22 Switching Energy vs. Temperature

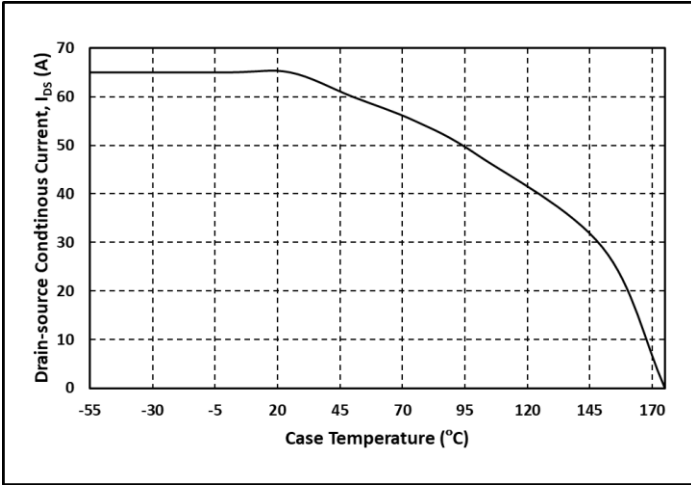

Fig. 23 Continuous Drain Current vs. Case Temperature

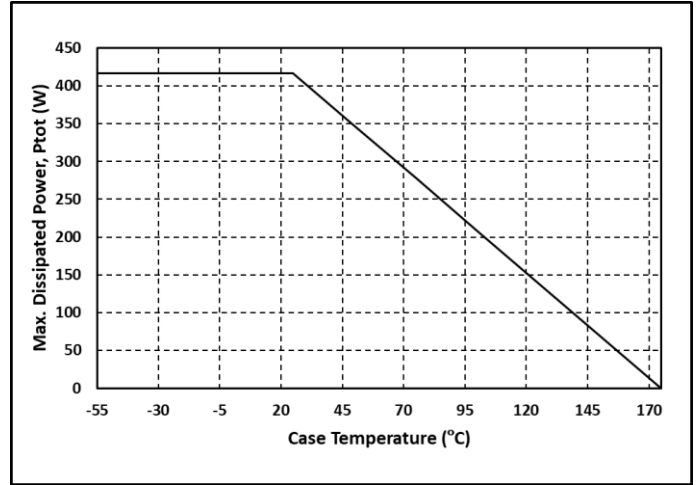

Fig. 24 Max. Power Dissipation Derating vs. Case Temperature

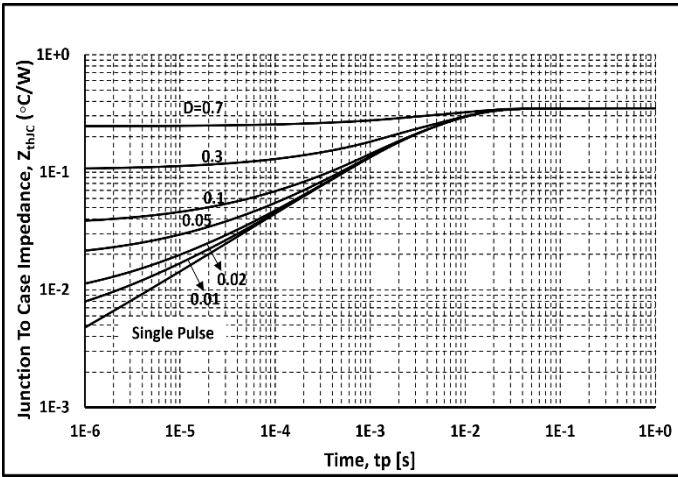

Fig. 25 Thermal impedance

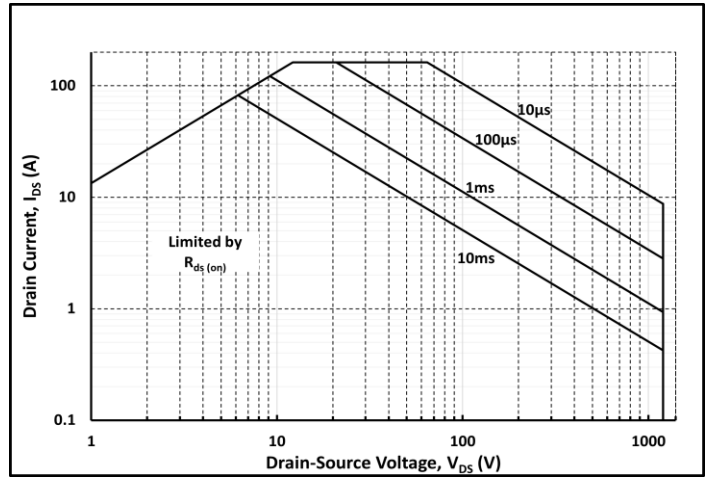
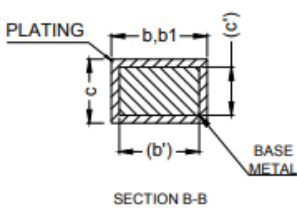
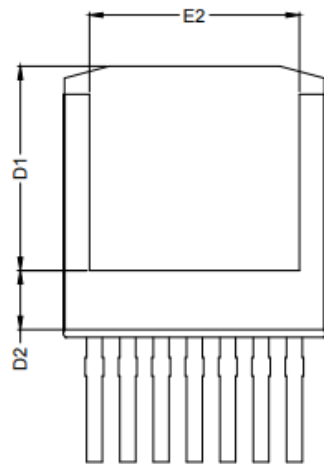
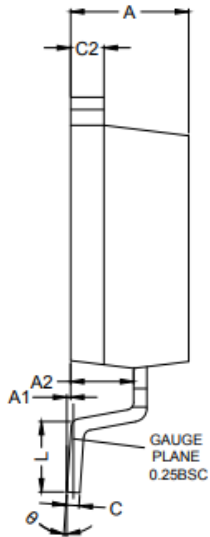
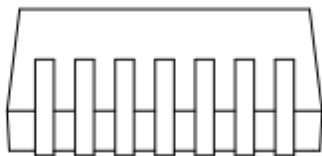
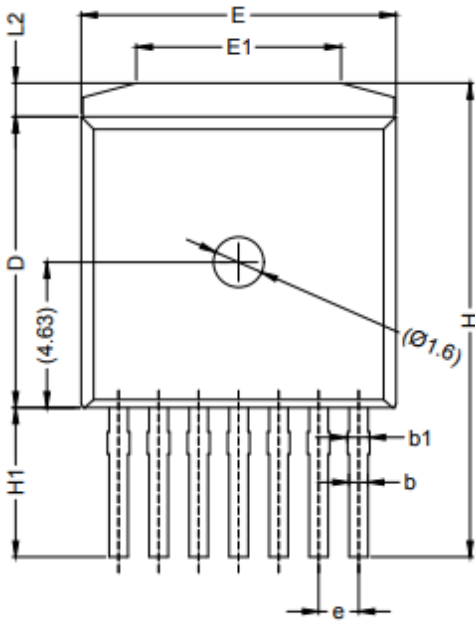

Fig. 26 Safe Operating Area

Package Dimensions



Items	Min	Max
A	4.30	4.70
A1	-	0.25
A2	2.20	2.60
b	0.52	0.72
b'	0.50	0.70
b1	0.60	0.80
c	0.42	0.62
c'	0.40	0.60
c2	1.07	1.47
D	9.05	9.45
D1	7.58	7.98
D2	2.05	2.45
e	1.27 BSC	
E	9.80	10.20
E1	6.30	6.70
E2	7.80	8.20
L	2.48	2.88
L2	0.87	1.27
H	14.87	15.27
H1	4.55	4.95
θ	0°	8°

Note:

1. Package Reference: JEDEC TO263, Variation AD
2. All Dimensions are in mm
3. Subject to Change Without Notice

Notes

For further information please contact IVCT's office.

Copyright©2023 InventChip Technology Co., Ltd. All rights reserved.

The Information in this document is subject to change without notice.

Related Links

<http://www.inventchip.com.cn>



单击下面可查看定价，库存，交付和生命周期等信息

[>>Inventchip\(瞻芯电子\)](#)