

IVST12050SA1L – 1200V 50mΩ SiC MODULE

Features

- High blocking voltage with low on-resistance
- High speed switching with low capacitance
- High operating junction temperature capability
- Very fast and robust intrinsic body diode
- Kelvin gate input easing driver circuit design

Applications

- Solar inverters
- UPS application
- High voltage DC/DC converters
- Switch mode power supplies

Package

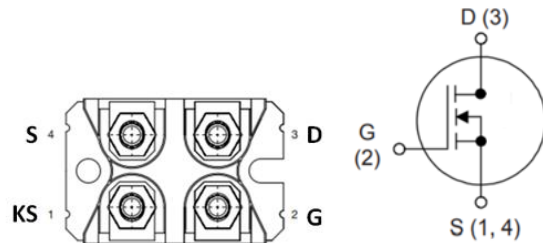

Part Number	Package
IVST12050SA1L	SOT 227

Absolute Maximum Ratings ($T_c=25^\circ\text{C}$ unless otherwise specified)

Symbol	Parameter	Value	Unit	Test Conditions	Note
V_{DS}	Drain-Source voltage	1200	V	$V_{GS}=0\text{V}$, $I_D=100\mu\text{A}$	
$V_{GSmax}(DC)$	Maximum DC voltage	-5 to 22	V	Static (DC)	
$V_{GSmax}(Spike)$	Maximum spike voltage	-10 to 25	V	<1% duty cycle, and pulse width<200ns	
V_{GSon}	Recommended turn-on voltage	20 ± 0.5	V		
V_{GSoff}	Recommended turn-off voltage	-3.5 to -2	V		
I_D	Drain current (continuous)	64	A	$V_{GS}=20\text{V}$, $T_c=25^\circ\text{C}$	Fig. 21
		45	A	$V_{GS}=20\text{V}$, $T_c=100^\circ\text{C}$	
I_{DM}	Drain current (pulsed)	160	A	Pulse width limited by SOA	Fig. 24
P_{TOT}	Total power dissipation	413	W	$T_c=25^\circ\text{C}$	Fig. 22
T_{stg}	Storage temperature range	-55 to 175	$^\circ\text{C}$		
T_J	Operating junction temperature	-55 to 175	$^\circ\text{C}$		

Thermal Data

Symbol	Parameter	Value	Unit	Note
$R_{\theta(j-c)}$	Thermal Resistance from Junction to Case	0.363	$^\circ\text{C}/\text{W}$	Fig. 23

Electrical Characteristics ($T_c=25^\circ\text{C}$ unless otherwise specified)

Symbol	Parameter	Value			Unit	Test Conditions	Note
		Min.	Typ.	Max.			
I_{DSS}	Zero gate voltage drain current		5	100	μA	$V_{DS}=1200\text{V}, V_{GS}=0\text{V}$	
I_{GSS}	Gate leakage current			± 100	nA	$V_{DS}=0\text{V}, V_{GS}=-5\sim 20\text{V}$	
V_{TH}	Gate threshold voltage	1.8	3.2	5	V	$V_{GS}=V_{DS}, I_D=6\text{mA}$	Fig. 8, 9
			2.2			$V_{GS}=V_{DS}, I_D=6\text{mA}$ @ $T_c=175^\circ\text{C}$	
R_{ON}	Static drain-source on-resistance		50	65	$\text{m}\Omega$	$V_{GS}=20\text{V}, I_D=20\text{A}$ @ $T_j=25^\circ\text{C}$	Fig. 4, 5, 6, 7
			80		$\text{m}\Omega$	$V_{GS}=20\text{V}, I_D=20\text{A}$ @ $T_j=175^\circ\text{C}$	
C_{iss}	Input capacitance		2750		pF	$V_{DS}=800\text{V}, V_{GS}=0\text{V},$ $f=1\text{MHz}, V_{AC}=25\text{mV}$	Fig. 16
C_{oss}	Output capacitance		106		pF		
C_{rss}	Reverse transfer capacitance		5.2		pF		
E_{oss}	C_{oss} stored energy		43		μJ		Fig. 17
Q_g	Total gate charge		120		nC	$V_{DS}=800\text{V}, I_D=20\text{A},$ $V_{GS}=-5\text{ to }20\text{V}$	Fig. 18
Q_{gs}	Gate-source charge		25		nC		
Q_{gd}	Gate-drain charge		48		nC		
R_g	Gate input resistance		2.8		Ω	$f=1\text{MHz}$	
E_{ON}	Turn-on switching energy		684.2		μJ	$V_{DS}=800\text{V}, I_{DS}=30\text{A},$ $V_{GS}=-3.5\text{V}\sim 20\text{V},$ $R_{G(\text{ext})}=3.3\Omega,$ $L=270\mu\text{H}$	Fig. 19, 20
E_{OFF}	Turn-off switching energy		77.8		μJ		
$t_{d(\text{on})}$	Turn-on delay time		14.7		ns		
t_r	Rise time		28.5				
$t_{d(\text{off})}$	Turn-off delay time		23.1				
t_f	Fall time		12.4				

Reverse Diode Characteristics ($T_c=25^\circ\text{C}$ unless otherwise specified)

Symbol	Parameter	Value			Unit	Test Conditions	Note
		Min.	Typ.	Max.			
V_{SD}	Diode forward voltage		4.9		V	$I_{SD}=20\text{A}, V_{GS}=0\text{V}$	Fig. 10, 11, 12
			4.4		V	$I_{SD}=20\text{A}, V_{GS}=0\text{V}, T_J=175^\circ\text{C}$	
t_{rr}	Reverse recovery time		54.6		ns	$V_{GS}=-3.5\text{V}/+20\text{V}, I_{SD}=30\text{A}, V_R=800\text{V}, di/dt=2000\text{A}/\mu\text{s}, R_{G(\text{ext})}=16\Omega, L=270\mu\text{H}$	
Q_{rr}	Reverse recovery charge		233		nC		
I_{RRM}	Peak reverse recovery current		17.2		A		

Module Characteristics

Symbol	Parameter	Conditions	Value			Unit
			Min.	Typ.	Max.	
V_{ISOL}	Isolation test voltage	RMS, $f=50\text{Hz}, t=1\text{min}$			2.5	kV
T_{stg}	Storage temperature		-40		150	$^\circ\text{C}$
M	Terminal connection torque	Screw M4	1.1		1.5	N·m
	Mounting torque	Screw M4	1.1		1.5	N·m
G	Weight of module			27		g
	Creepage distance	Terminal to heatsink		10.61		mm
		Terminal to terminal		10.37		mm
	Clearance	Terminal to heatsink		6.7		mm
		Terminal to terminal		4.05		mm

Typical Performance (curves)

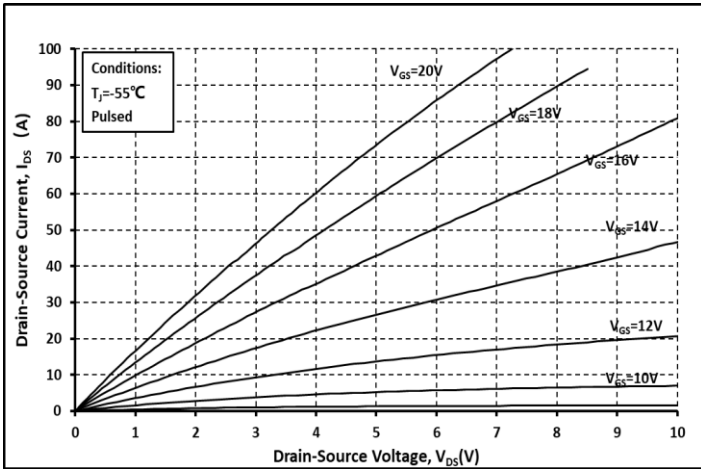

Fig. 1 Output Curve @ $T_j = -55^\circ\text{C}$

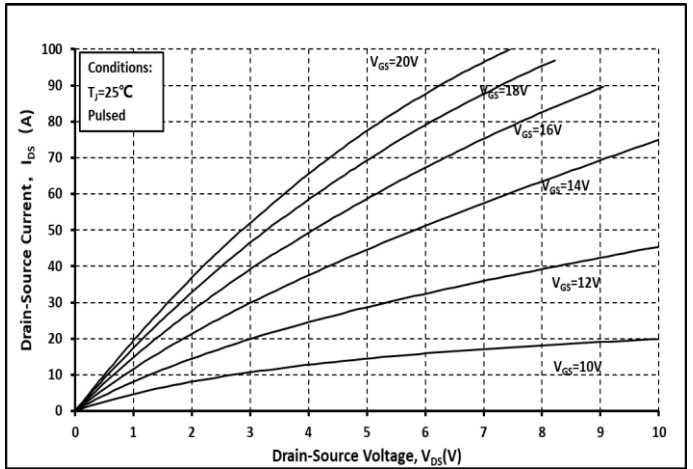

Fig. 2 Output Curve @ $T_j = 25^\circ\text{C}$

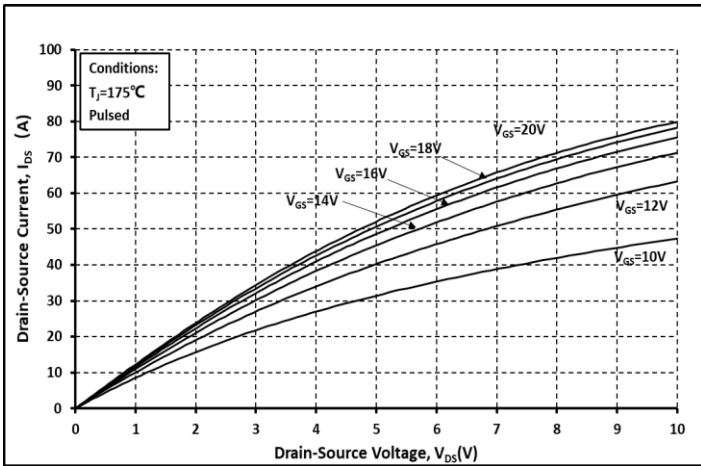

Fig. 3 Output Curve @ $T_j = 175^\circ\text{C}$

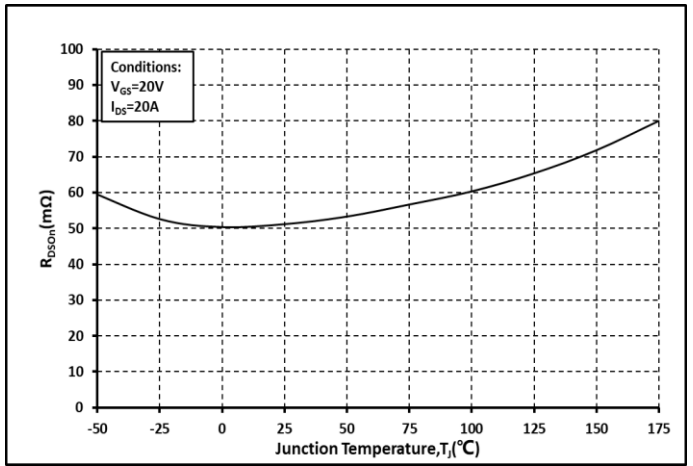

Fig. 4 R_{on} vs. Temperature

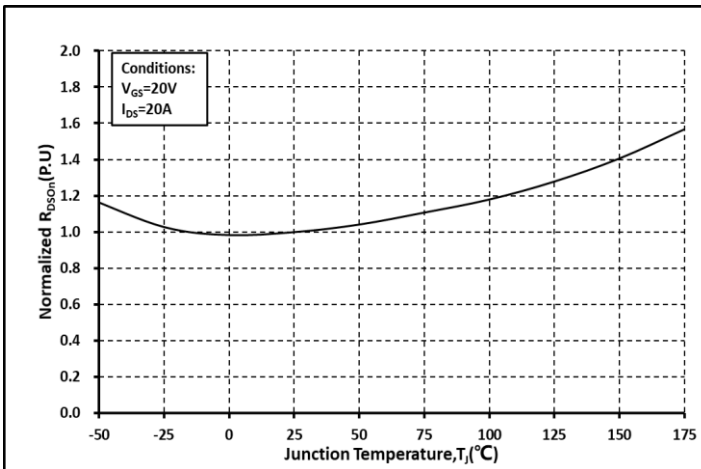

Fig. 5 Normalized R_{on} vs. Temperature

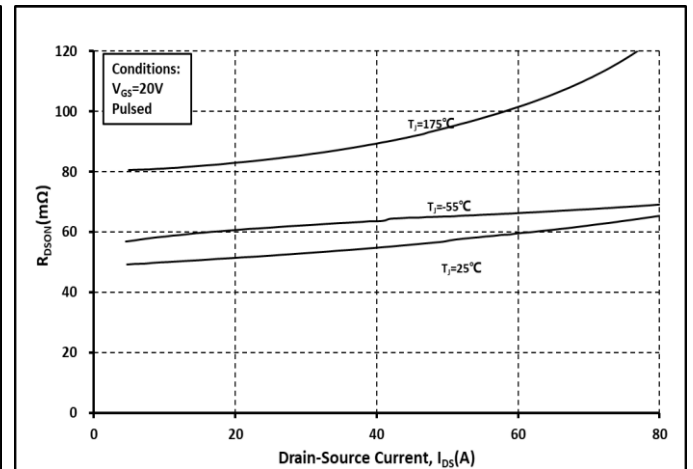

Fig. 6 R_{on} vs. I_{DS} @ Various Temperature

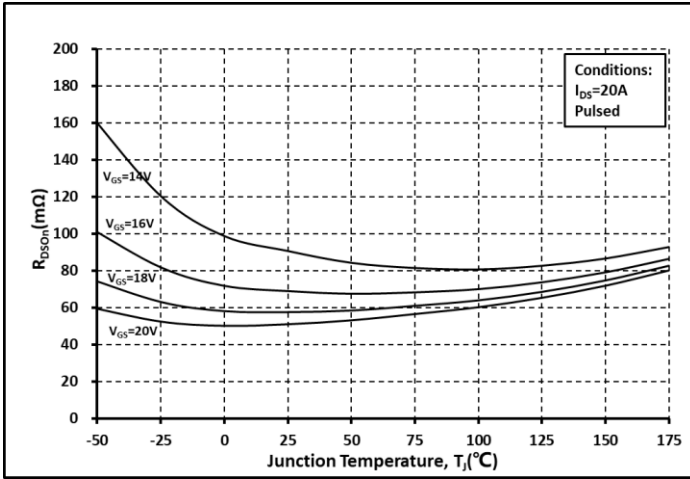

Fig. 7 Ron vs. Temperature @ Various V_{GS}

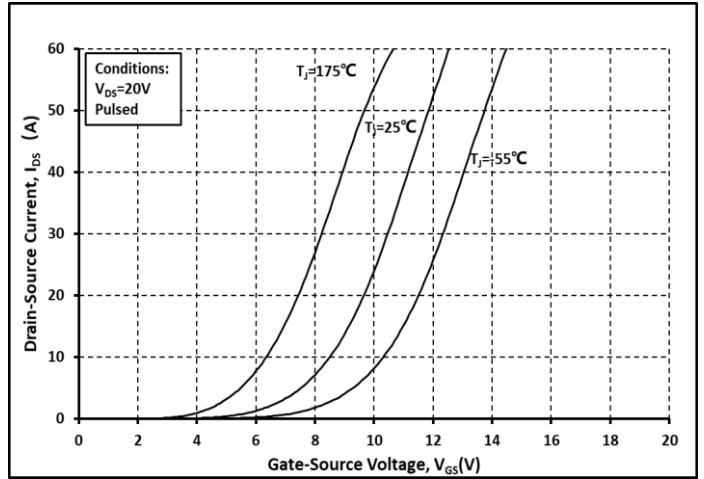

Fig. 8 Transfer Curves @ Various Temperature

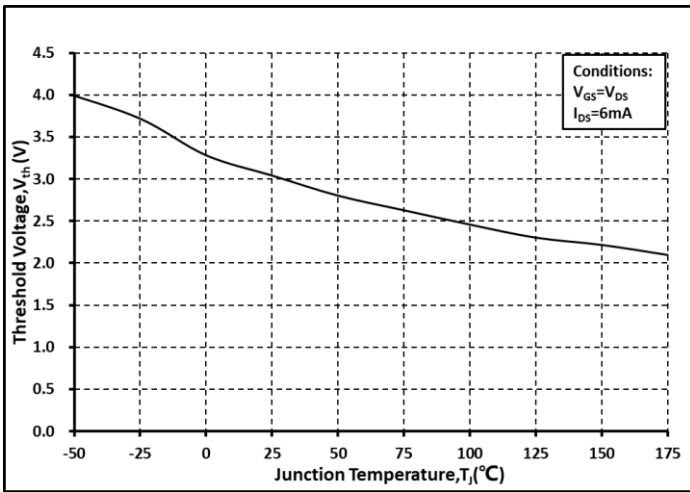

Fig. 9 Threshold Voltage vs. Temperature

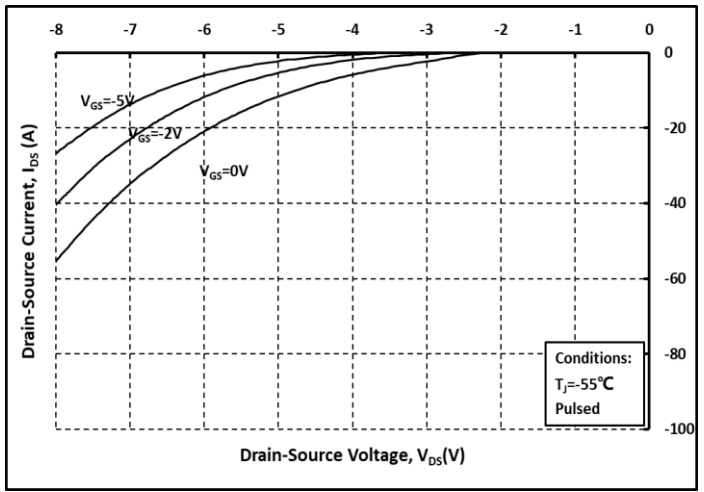

Fig. 10 Body Diode Curves @ $T_J = -55^\circ\text{C}$

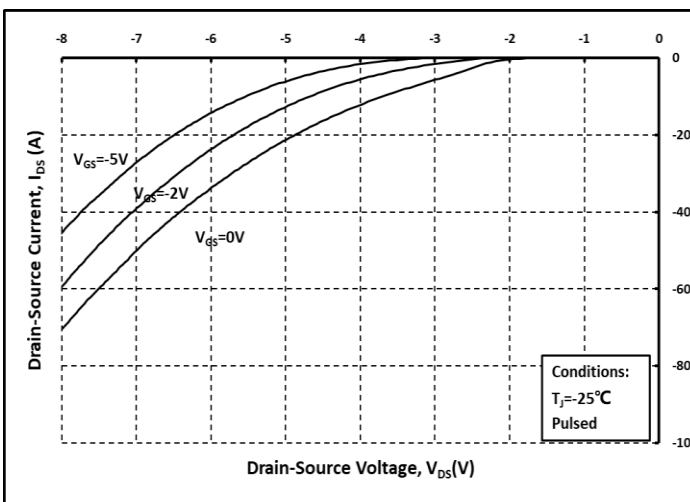

Fig. 11 Body Diode Curves @ $T_J = 25^\circ\text{C}$

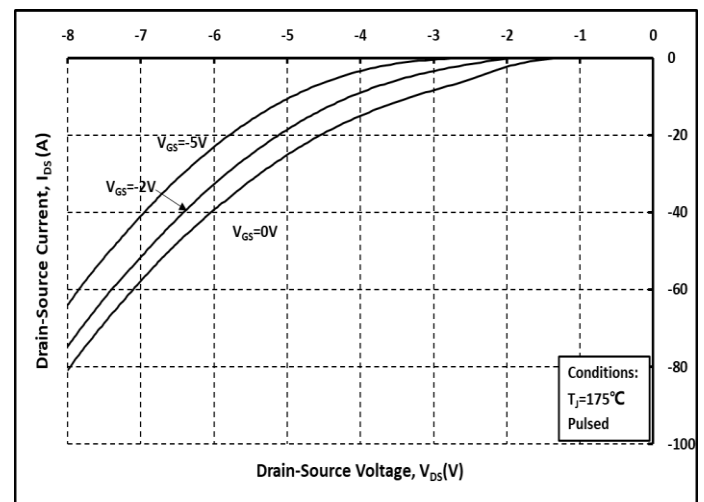

Fig. 12 Body Diode Curves @ $T_J = 175^\circ\text{C}$

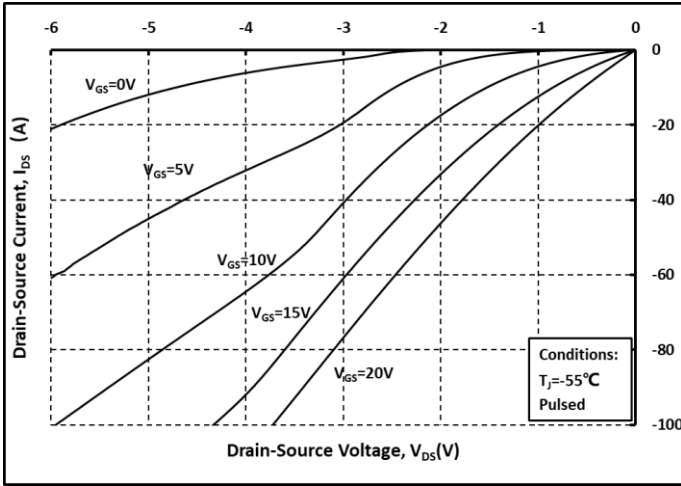

Fig. 13 3rd Quadrant Curves @ $T_j = -55^\circ\text{C}$

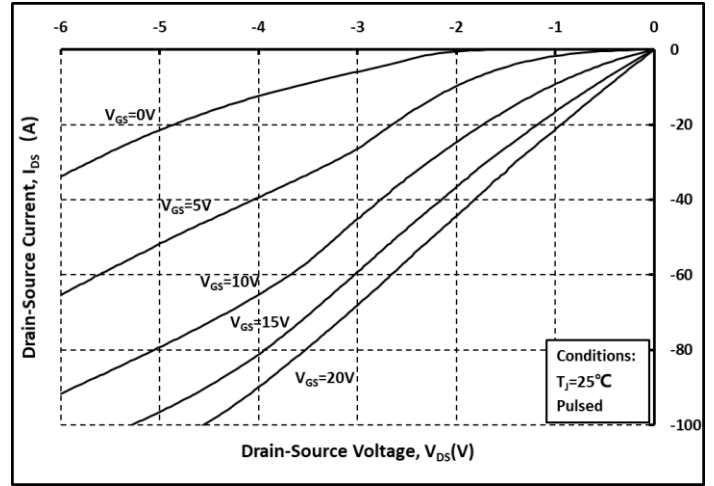

Fig. 14 3rd Quadrant Curves @ $T_j = 25^\circ\text{C}$

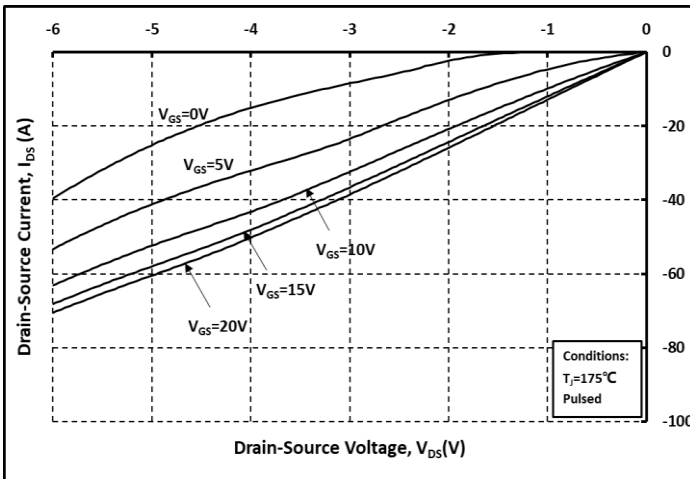

Fig. 15 3rd Quadrant Curves @ $T_j = 175^\circ\text{C}$

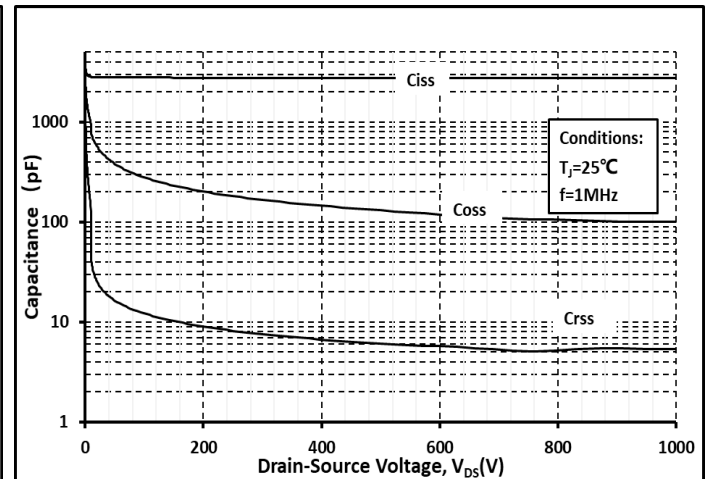

Fig. 16 Capacitance vs. V_{DS}

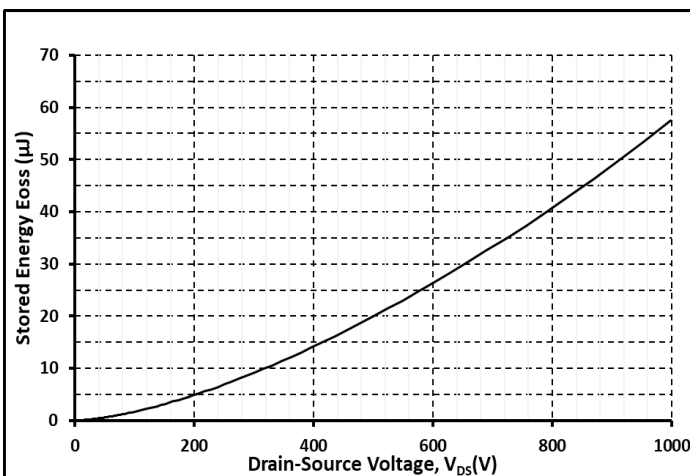

Fig. 17 Output Capacitor Stored Energy

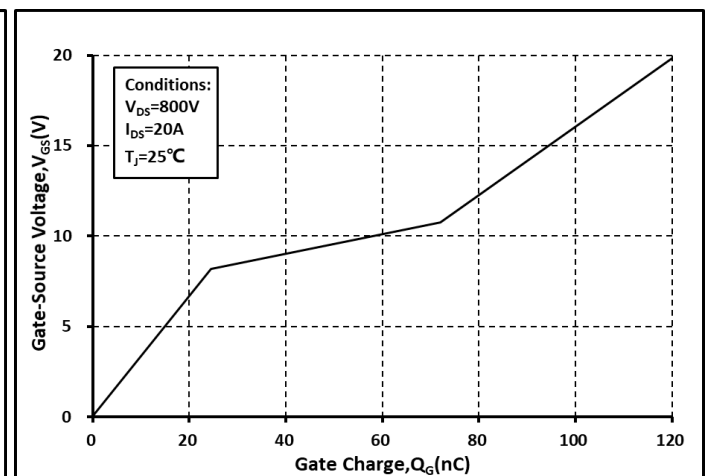

Fig. 18 Gate Charge Characteristics

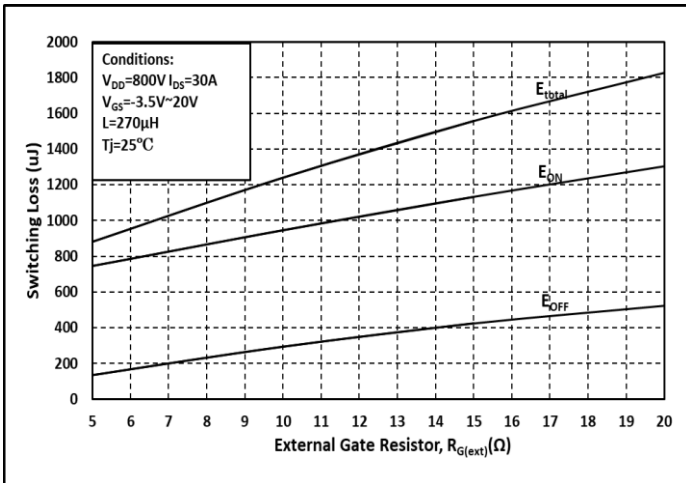

Fig. 19 Switching Energy vs. $R_{G(ext)}$

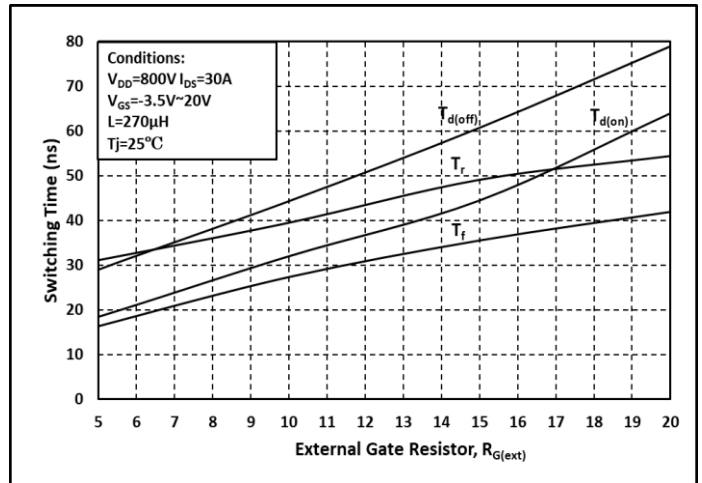

Fig. 20 Switching Times vs. $R_{G(ext)}$

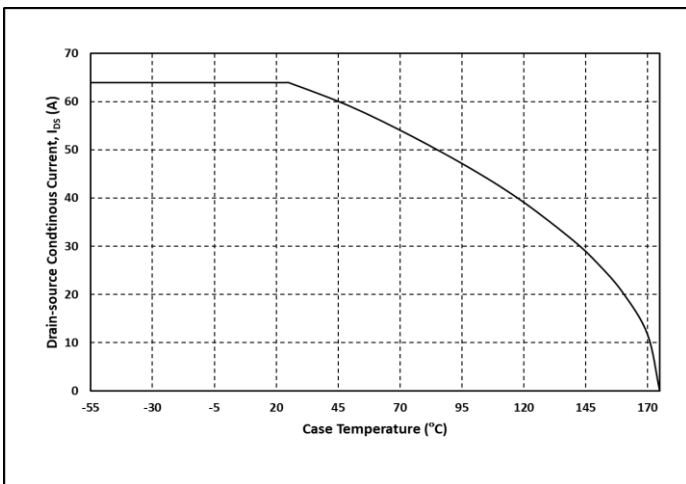

Fig. 21 Continuous Drain Current vs. Case Temperature

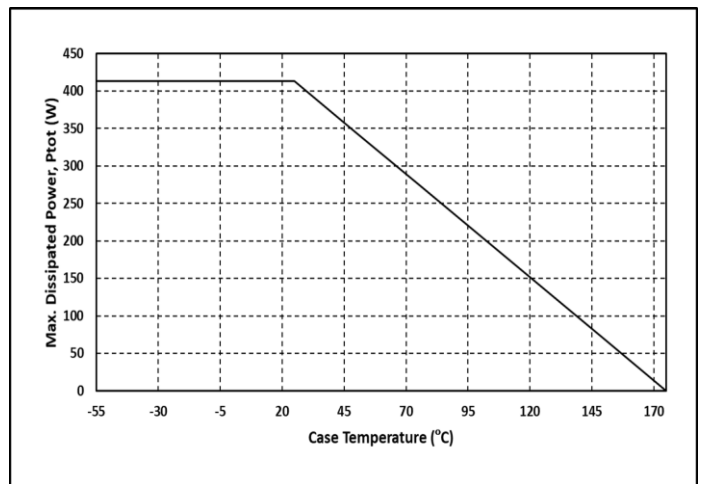

Fig. 22 Max. Power Dissipation Derating vs. Case Temperature

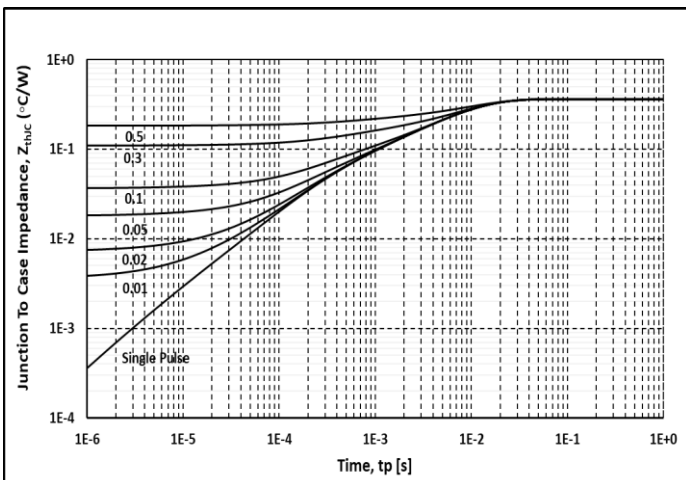

Fig. 23 Thermal Impedance

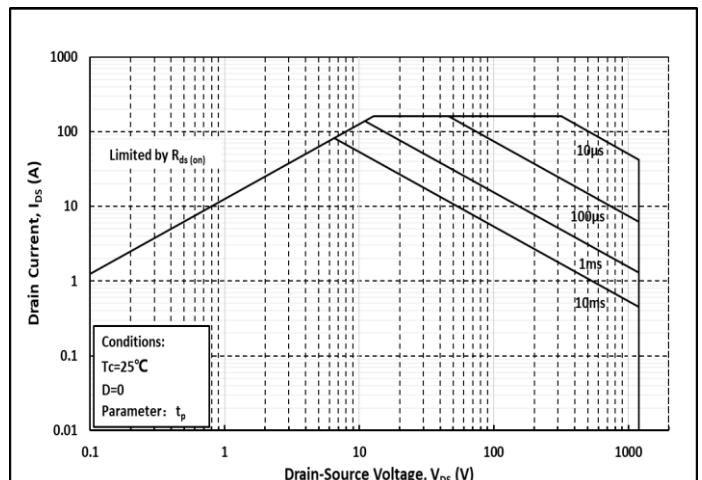
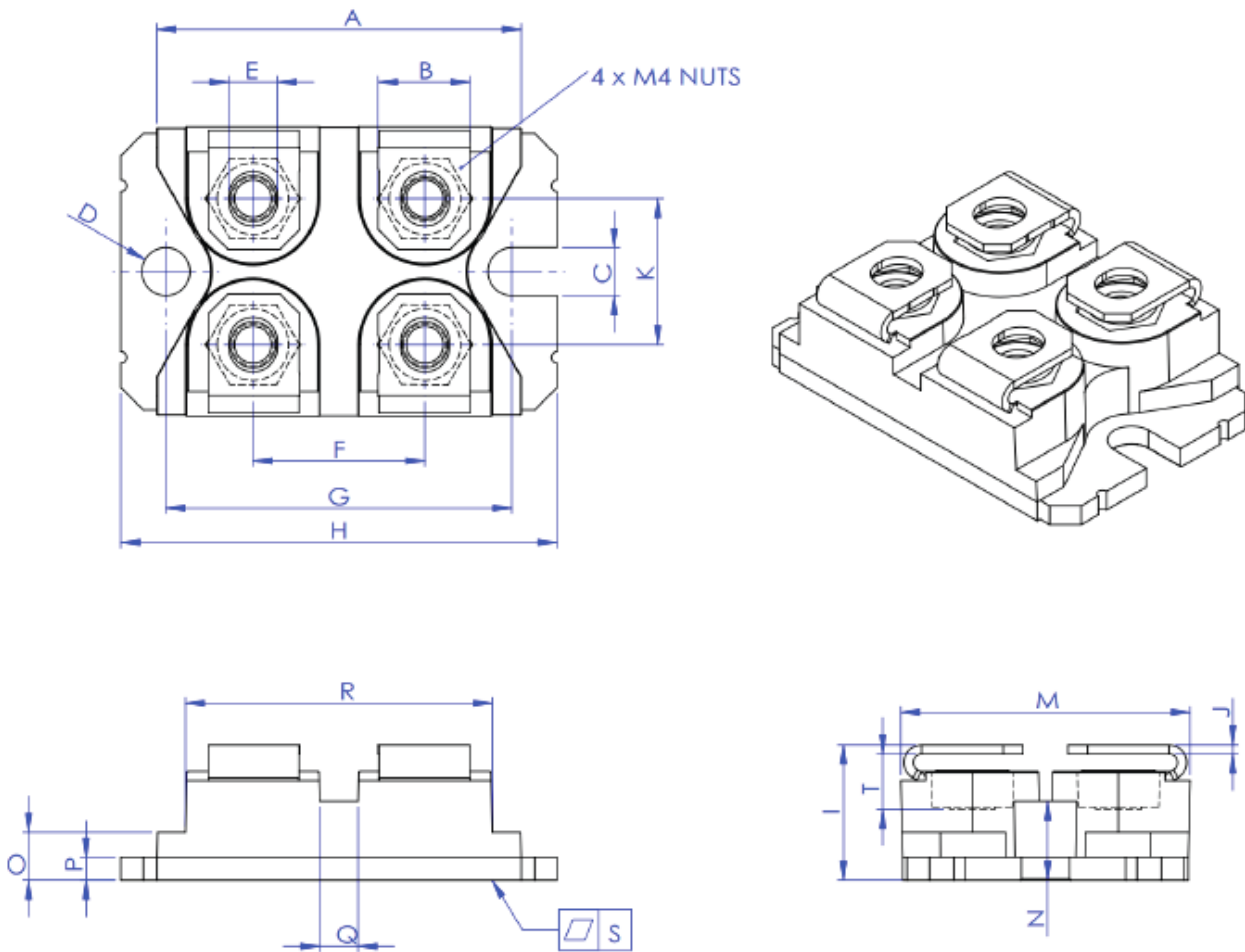

Fig. 24 Safe Operating Area

Package Dimensions



Dimension	Millimeter		Typical
	Min	Max	
A	31.50	32.00	31.70
B	7.70	8.30	8.00
C	4.10	4.30	4.20
D	4.10	4.30	4.20
E	4.10	4.30	4.20
F	14.90	15.15	15.0
G	29.80	30.40	30.10
H	37.80	38.30	38.05
I	11.80	12.30	12.05
J	0.75	0.85	0.80
K	12.50	13.00	12.75
M	25.00	25.50	25.30
N	6.75	7.10	6.90
O	4.00	4.40	4.20
P	1.90	2.10	2.00
Q	3.20	3.60	3.40
R	26.60	27.00	26.80
S	-0.03	0.10	0.01
T	4.85	5.25	5.05

Notes

For further information please contact IVCT's Office.

Copyright©2022 InventChip Technology Co., Ltd. All rights reserved.

The Information in this document is subject to change without notice.

Related Links

<http://www.inventchip.com.cn>



单击下面可查看定价，库存，交付和生命周期等信息

[>>Inventchip\(瞻芯电子\)](#)