



Surface Mount Schottky Barrier Rectifier

Reverse Voltage - 60~100 V

Forward Current - 5.0A

PINNING

PIN	DESCRIPTION
1	Cathode
2	Anode

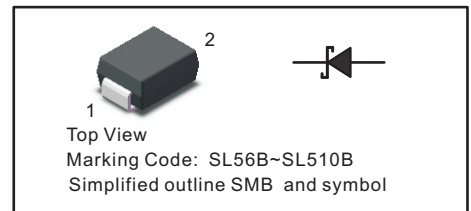

Features

- Metal silicon junction, majority carrier conduction
- For surface mounted applications
- Low power loss, high efficiency
- High forward surge current capability
- For use in low voltage, high frequency inverters, free wheeling, and polarity protection applications

MECHANICAL DATA

- Case: SMB
- Terminals: Solderable per MIL-STD-750, Method 2026
- Approx. Weight: 0.1g / 0.0034oz

Absolute Maximum Ratings and Electrical characteristics

Ratings at 25 °C ambient temperature unless otherwise specified. Single phase, half wave, 60Hz resistive or inductive load, for capacitive load, derate by 20 %

Parameter	Symbols	SSL56B	SSL510B	Units
Maximum Repetitive Peak Reverse Voltage	V_{RRM}	60	100	V
Maximum RMS voltage	V_{RMS}	42	70	V
Maximum DC Blocking Voltage	V_{DC}	60	100	V
Maximum Average Forward Rectified Current	$I_{F(AV)}$	5.0		A
Peak Forward Surge Current, 8.3ms Single Half Sine-wave Superimposed on Rated Load (JEDEC method)	I_{FSM}	150		A
Max Instantaneous Forward Voltage at 5 A	V_F	0.5	0.6	V
Maximum DC Reverse Current $T_a = 25^{\circ}C$ at Rated DC Reverse Voltage $T_a = 100^{\circ}C$	I_R	1.0 50		mA
Typical Junction Capacitance ⁽¹⁾	C_j	600		pF
Typical Thermal Resistance ⁽²⁾	$R_{\theta JA}$	45		$^{\circ}C/W$
Operating Junction Temperature Range	T_j	-55 ~ +150		$^{\circ}C$
Storage Temperature Range	T_{stg}	-55 ~ +150		$^{\circ}C$

(1) Measured at 1 MHz and applied reverse voltage of 4 V D.C

(2) P.C.B. mounted with 2.0" X 2.0" (5 X 5 cm) copper pad areas.



Fig.1 Forward Current Derating Curve

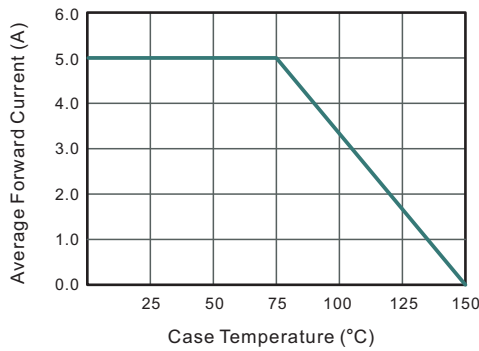

Fig.2 Typical Reverse Characteristics

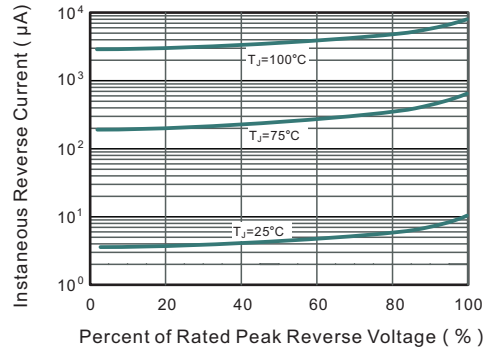

Fig.3 Typical Forward Characteristic

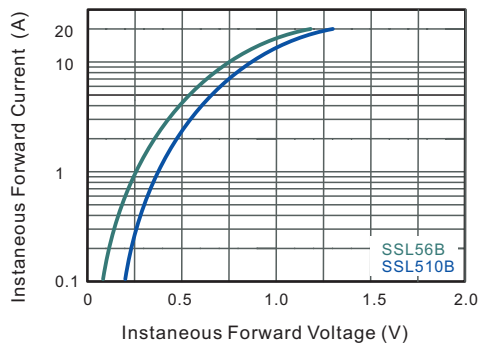

Fig.4 Typical Junction Capacitance

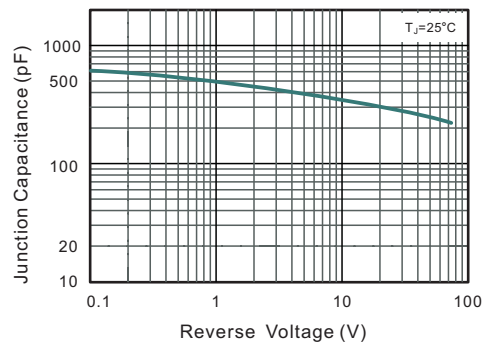

Fig.5 Maximum Non-Repetitive Peak Forward Surge Current

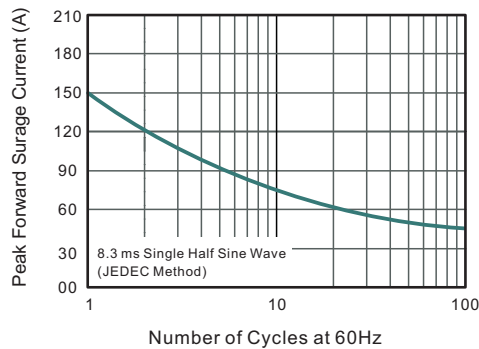
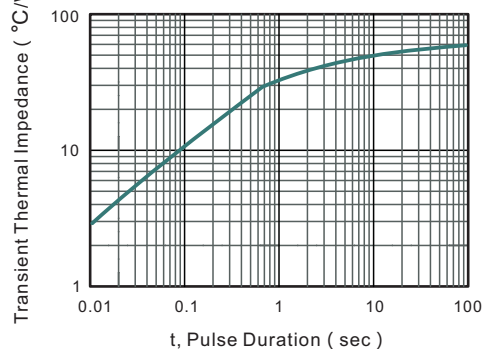

Fig.6- Typical Transient Thermal Impedance





PACKAGE OUTLINE

Plastic surface mounted package; 2 leads

SMB

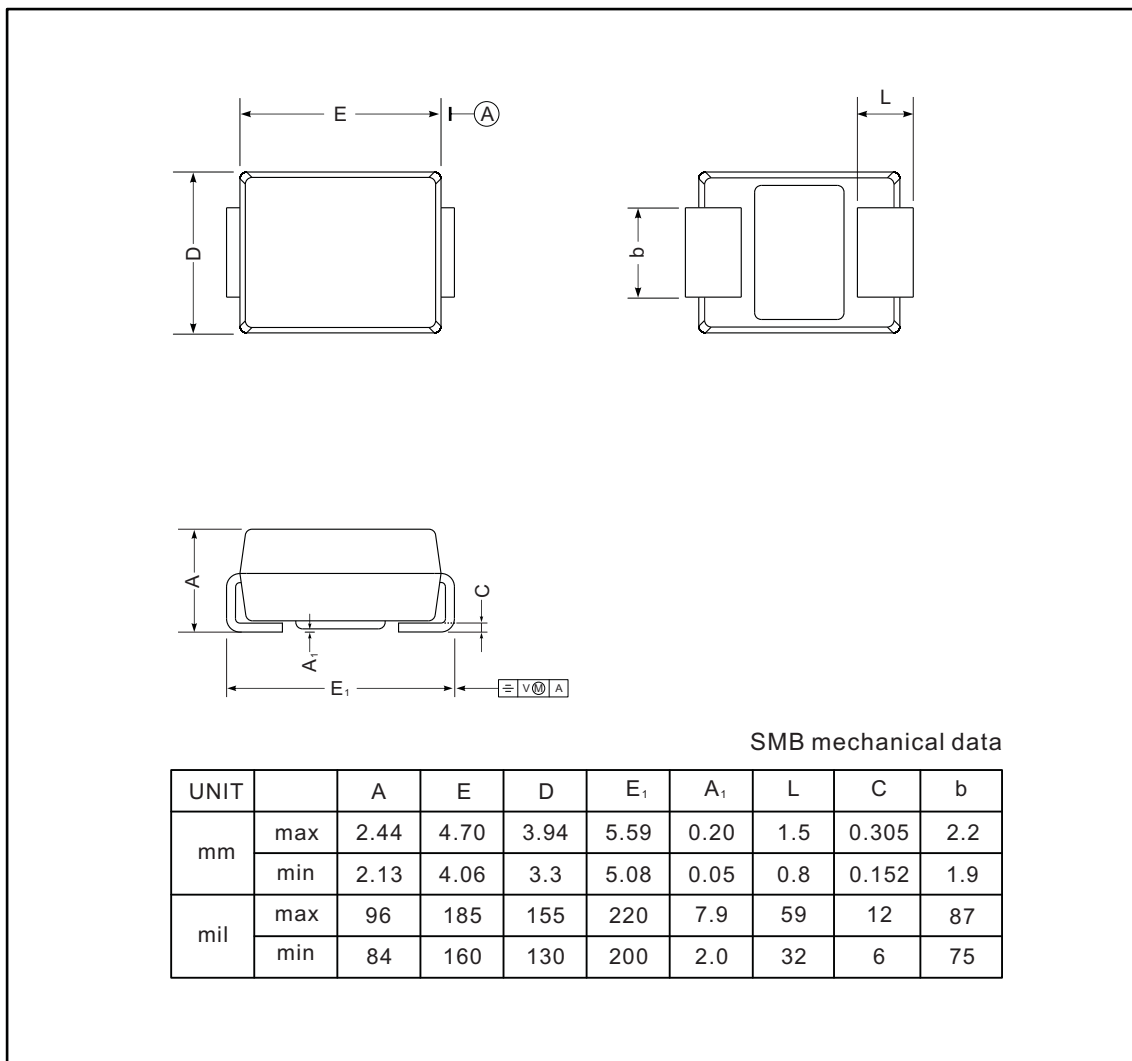

The recommended mounting pad size

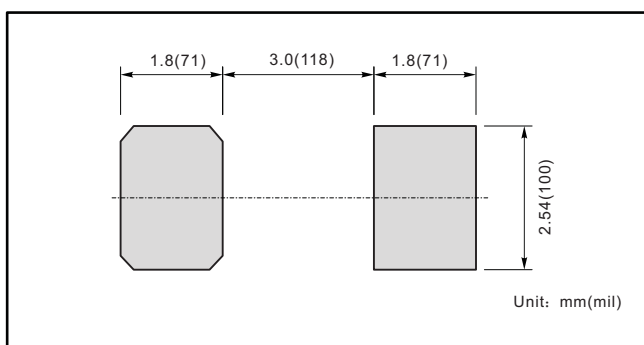

Marking

Type number	Marking code
SSL56B	SL56B
SSL510B	SL510B

单击下面可查看定价，库存，交付和生命周期等信息

[>>JINGDAO\(晶导\)](#)