



Surface Mount Schottky Barrier Rectifier
Reverse Voltage - 20 to 200V
Forward Current - 3.0A

FEATURES

- Metal silicon junction, majority carrier conduction
- For surface mounted applications
- Low power loss, high efficiency
- High forward surge current capability
- For use in low voltage, high frequency inverters, free wheeling, and polarity protection applications

MECHANICAL DATA

- Case: SMBF
- Terminals: Solderable per MIL-STD-750, Method 2026
- Approx. Weight: 57mg / 0.002oz

PINNING

| PIN | DESCRIPTION |
|-----|-------------|
| 1 | Cathode |
| 2 | Anode |

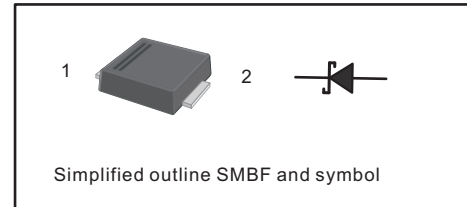

Absolute Maximum Ratings and Electrical characteristics

Ratings at 25 °C ambient temperature unless otherwise specified. Single phase, half wave, 60Hz resistive or inductive load, for capacitive load, derate by 20 %

| Parameter | Symbols | SS32BF | SS34BF | SS345BF | SS36BF | SS38BF | SS310BF | SS312BF | SS315BF | SS320BF | Units |
|---|-----------------|------------|--------|---------|----------|--------|---------|---------|---------|---------|-------|
| Maximum Repetitive Peak Reverse Voltage | V_{RRM} | 20 | 40 | 45 | 60 | 80 | 100 | 120 | 150 | 200 | V |
| Maximum RMS voltage | V_{RMS} | 14 | 28 | 32 | 42 | 56 | 70 | 84 | 105 | 140 | V |
| Maximum DC Blocking Voltage | V_{DC} | 20 | 40 | 45 | 60 | 80 | 100 | 120 | 150 | 200 | V |
| Maximum Average Forward Rectified Current | $I_{F(AV)}$ | 3.0 | | | | | | | | | A |
| Peak Forward Surge Current, 8.3ms Single Half Sine-wave Superimposed on Rated Load (JEDEC method) | I_{FSM} | 80 | | | | | | | | | A |
| Max Instantaneous Forward Voltage at 3 A | V_F | 0.55 | | | 0.70 | | 0.85 | | 0.95 | | V |
| Maximum DC Reverse Current $T_a = 25^\circ\text{C}$ at Rated DC Reverse Voltage $T_a = 100^\circ\text{C}$ | I_R | 0.5 5 | | | 0.3 3 | | | | | | mA |
| Typical Junction Capacitance ⁽¹⁾ | C_j | 450 | | | 400 | | | | | | pF |
| Typical Thermal Resistance ⁽²⁾ | $R_{\theta JA}$ | 65 | | | | | | | | | °C/W |
| Operating Junction Temperature Range | T_j | -55 ~ +150 | | | | | | | | | °C |
| Storage Temperature Range | T_{stg} | -55 ~ +150 | | | | | | | | | °C |

(1) Measured at 1 MHz and applied reverse voltage of 4 V D.C

(2) P.C.B. mounted with 2.0" X 2.0" (5 X 5 cm) copper pad areas.



Fig.1 Forward Current Derating Curve

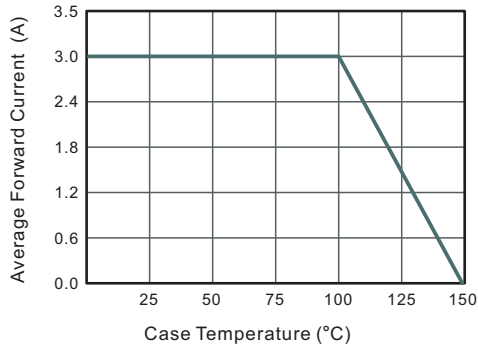

Fig.2 Typical Reverse Characteristics

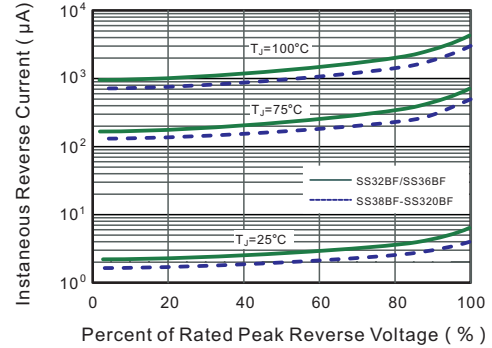

Fig.3 Typical Forward Characteristic

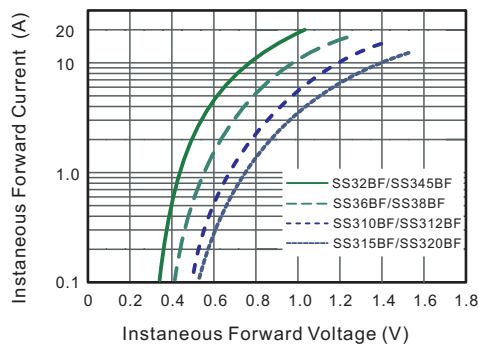

Fig.4 Typical Junction Capacitance

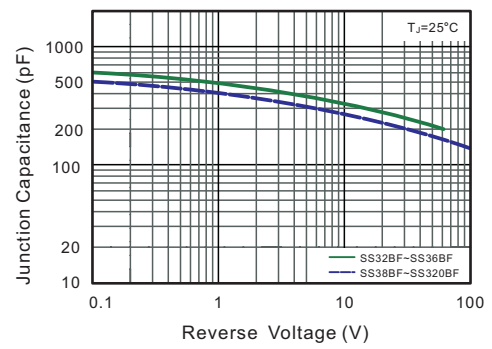

Fig.5 Maximum Non-Repetitive Peak Forward Surge Current

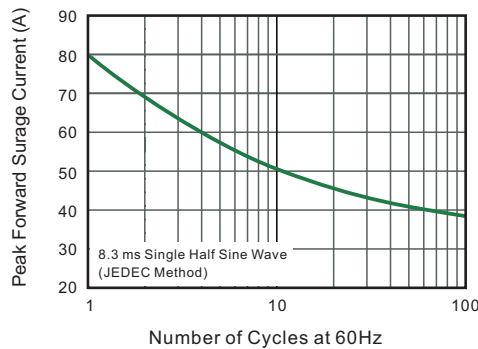
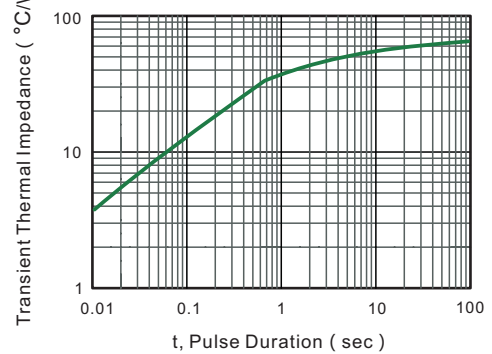

Fig.6- Typical Transient Thermal Impedance





PACKAGE OUTLINE

Plastic surface mounted package; 2 leads

SMBF

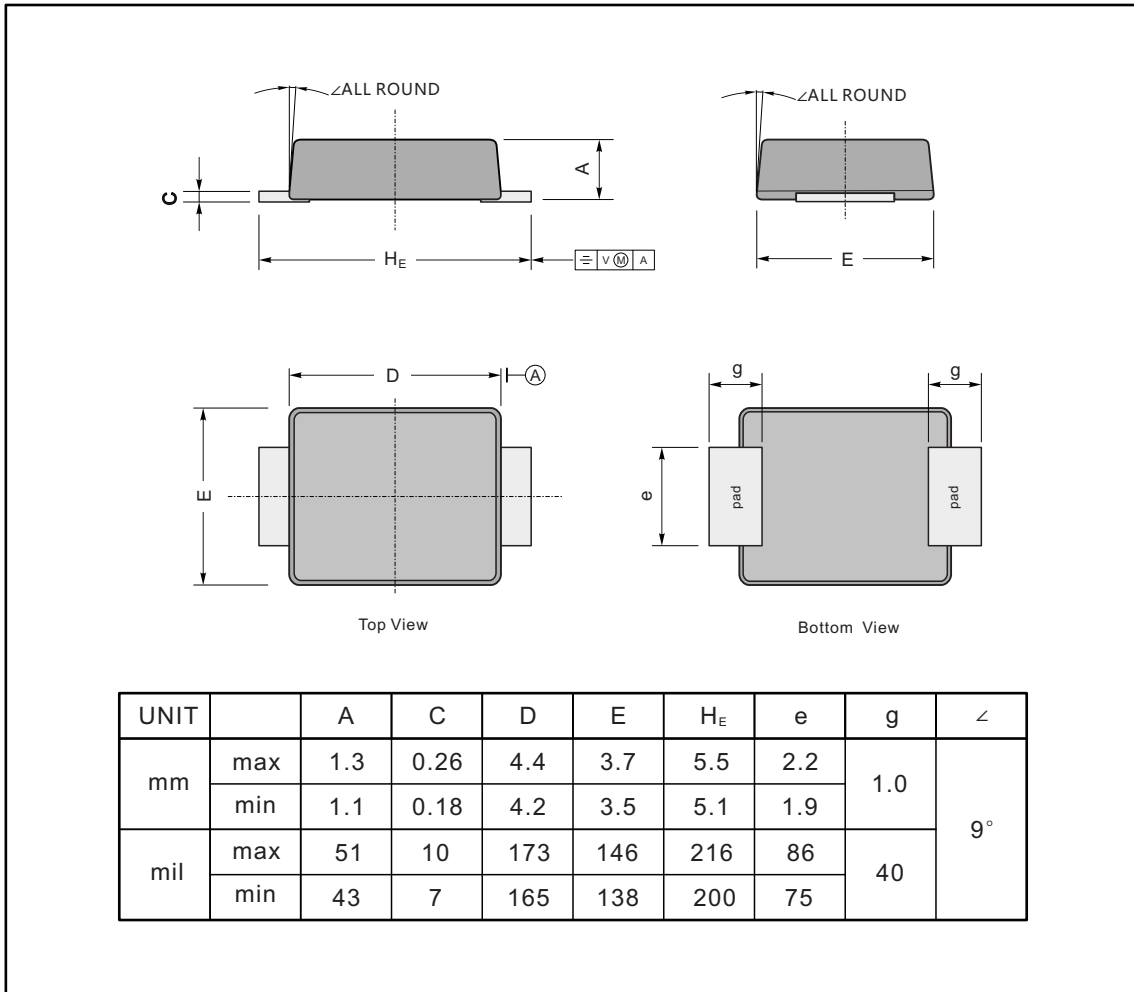

The recommended mounting pad size

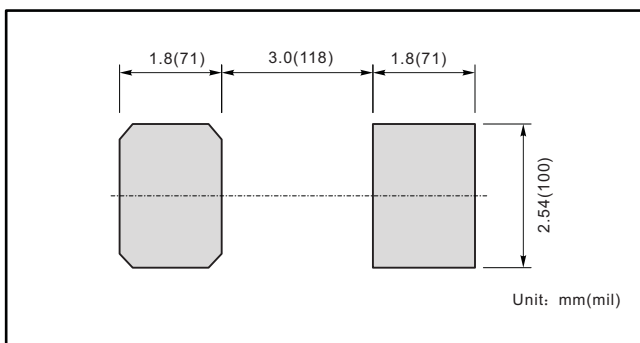

Marking

| Type number | Marking code |
|-------------|--------------|
| SS32BF | S32B |
| SS34BF | S34B |
| SS345BF | S345B |
| SS36BF | S36B |
| SS38BF | S38B |
| SS310BF | S310B |
| SS312BF | S312B |
| SS315BF | S315B |
| SS320BF | S320B |

单击下面可查看定价，库存，交付和生命周期等信息

[>>JINGDAO\(晶导\)](#)