



# 承 认 书

## SPECIFICATION FOR APPROVAL

客户名称: Customer \_\_\_\_\_

货 名: Description SMD 2520 XO CMOS 石英晶体振荡器

客户料号: Part No \_\_\_\_\_

物料编号: Code No O2250000153325

频 率: Frequency 50.000MHz

日 期: Date 2020-05-25

备 注: RoHS compliance with Directive (EU) 2015/863

| 制作(Prepare by) | 检查(Check by) | 批准 (Approve by) |
|----------------|--------------|-----------------|
| 江丹娜            | 甘瑛           | 张刚              |

|                             |  |
|-----------------------------|--|
| 客户批准<br>Approve by customer |  |
| 批准日期<br>Approval date       |  |

Add:广东省深圳市华发北路桑达工业区桑达雅苑 7P

7 P Sangda Yayuan Huafa North Road, Futian District, Shenzhen, Guangdong

Tel: 86-755-83048260

86-755-83048290

Fax: 86-755-83048280

## ■ ELECTRICAL SPECIFICATIONS

### Standard atmospheric conditions

Unless otherwise specified, the standard range of atmospheric conditions for making measurement and tests are as follow:

Ambient temperature : 25±5℃

Relative humidity : 40%~70%

If there is any doubt about the results, measurement shall be made within the following limits:

Ambient temperature : 25±3℃

Relative humidity : 40%~70%

### Measure equipment

Electrical characteristics measured by MD 37WX-05M or equivalent.

### Crystal cutting type

The crystal is using AT CUT (thickness shear mode).

## ■ Electrical characteristics

### Frequency

|    | Parameters                | Symbol | Electrical Spec. |      |        |         | Notes            |
|----|---------------------------|--------|------------------|------|--------|---------|------------------|
|    |                           |        | Min.             | Typ. | Max.   | Units   |                  |
| 1  | Nominal Frequency         | -      | 50.000           |      |        | MHz     | -                |
| 2  | Frequency Stability       | -      | ±25              |      |        | ppm     | -                |
| 3  | Operating Temperature     | Topr   | -40              | 25   | 85     | ℃       | -                |
| 4  | Storage Temperature       | Tstg   | -55              | ~    | 125    | ℃       | -                |
| 5  | Supply Voltage            | VDD    | 3.3 ±10%         |      |        | V       | -                |
| 6  | Input Current             | Icc    | -                | -    | 3      | mA      | -                |
| 7  | Enable Control            | -      | Yes              |      |        | -       | Pad 1            |
| 8  | Output Load : CMOS        | CL     | 15               |      |        | pF      | -                |
| 9  | Output Voltage High       | VoH    | 90%Vdd           | -    | -      | V       | -                |
| 10 | Output Voltage Low        | VoL    | -                | -    | 10%Vdd | V       | -                |
| 11 | Rise Time                 | Tr     | -                | -    | 10     | ns      | 10%→90%VDD Level |
| 12 | Fall Time                 | Tf     | -                | -    | 10     | ns      | 90%→10%VDD Level |
| 13 | Symmetry (Duty ratio)     | TH/T   | 45               | ~    | 55     | %       | -                |
| 14 | Start-up Time             | Tosc   | -                | -    | 10     | ms      | -                |
| 15 | Enable Voltage High       | Vhi    | 70%Vdd           | -    | -      | V       | -                |
| 16 | Disable Voltage Low       | Vlo    | -                | -    | 30%Vdd | V       | -                |
| 17 | Aging                     | -      | ±3               |      |        | ppm/yr. | 1st. Year at 25℃ |
| 18 | Output Disable Delay Time | T off  | -                | -    | 150    | μS      | -                |
| 19 | Output Enable Delay Time  | T on   | -                | -    | 150    | μS      | -                |

### ■ TEST DIAGRAM

Control input (output enable/disable)

Logic 1 or open on pad 1: Oscillator output

Logic 0 on pad 1 : Disable output to high impedance



### ■ WAVEFORM CONDITIONS

Waveform measurement system

should have a min. bandwidth of 5

times the frequency being tested.

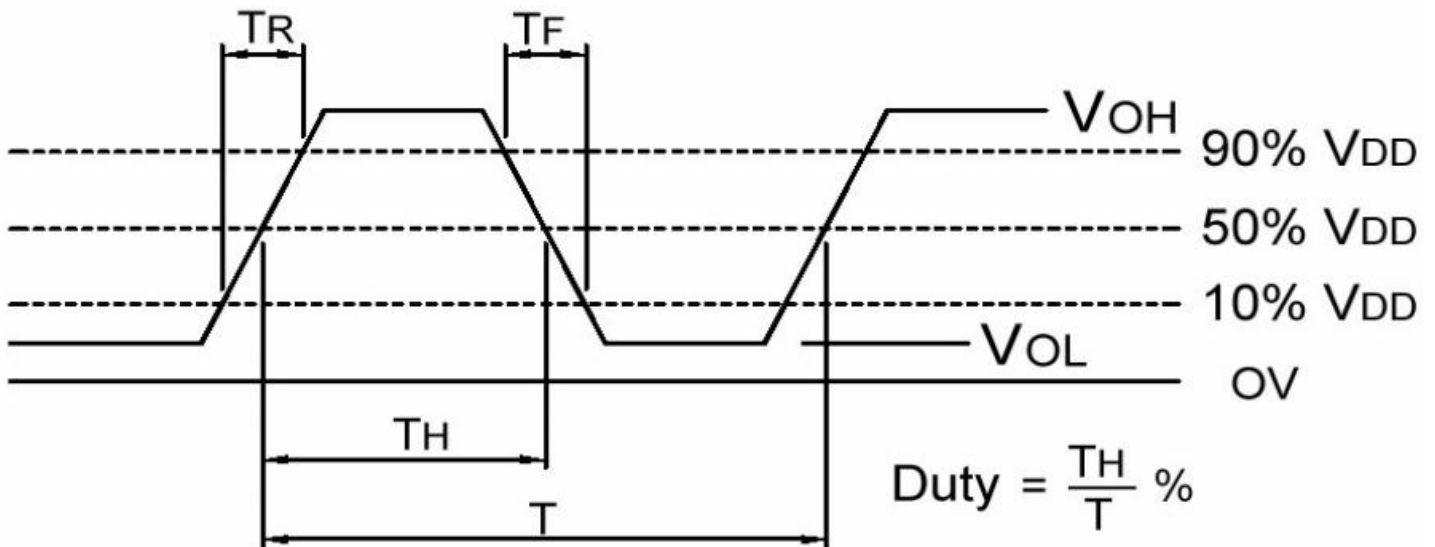

■ SUGGESTED REFLOW PROFILE

Total time : 200 sec. Max.

Solder melting point :220 °C

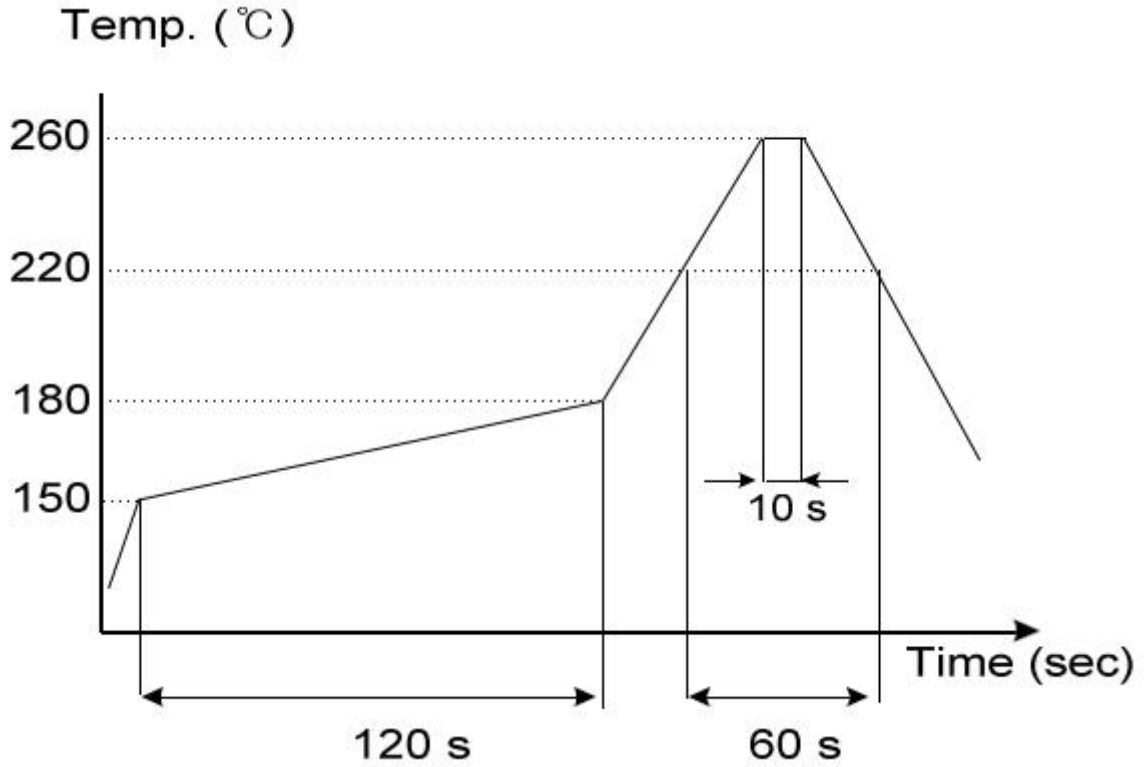

■ PRODUCT DIMENSIONS

(Unit:mm)

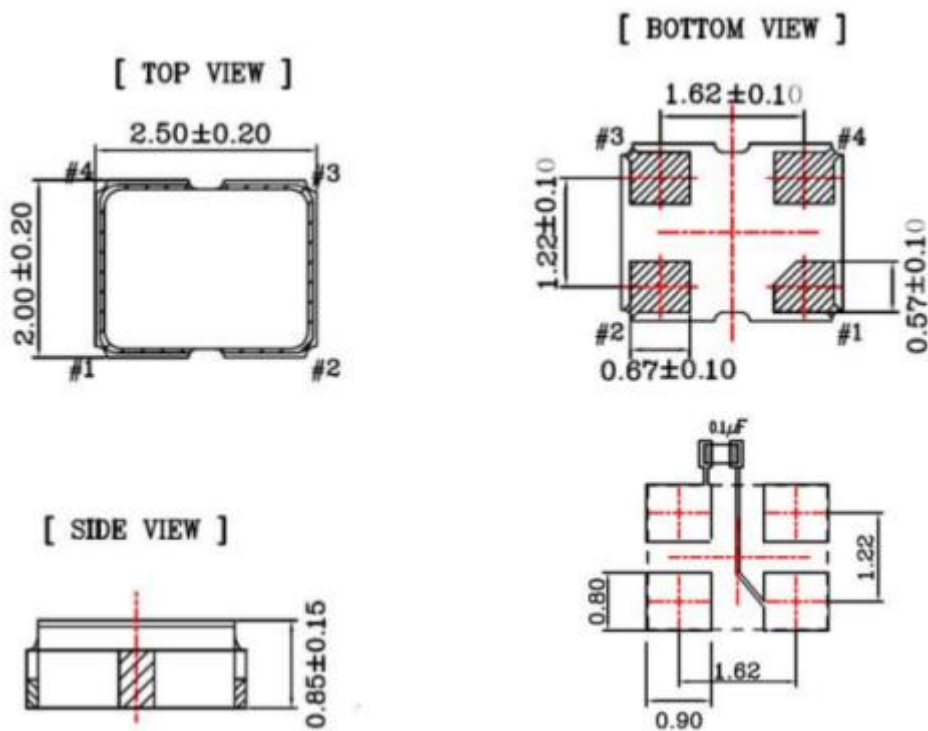

■ STRUCTURE ILLUSTRATION

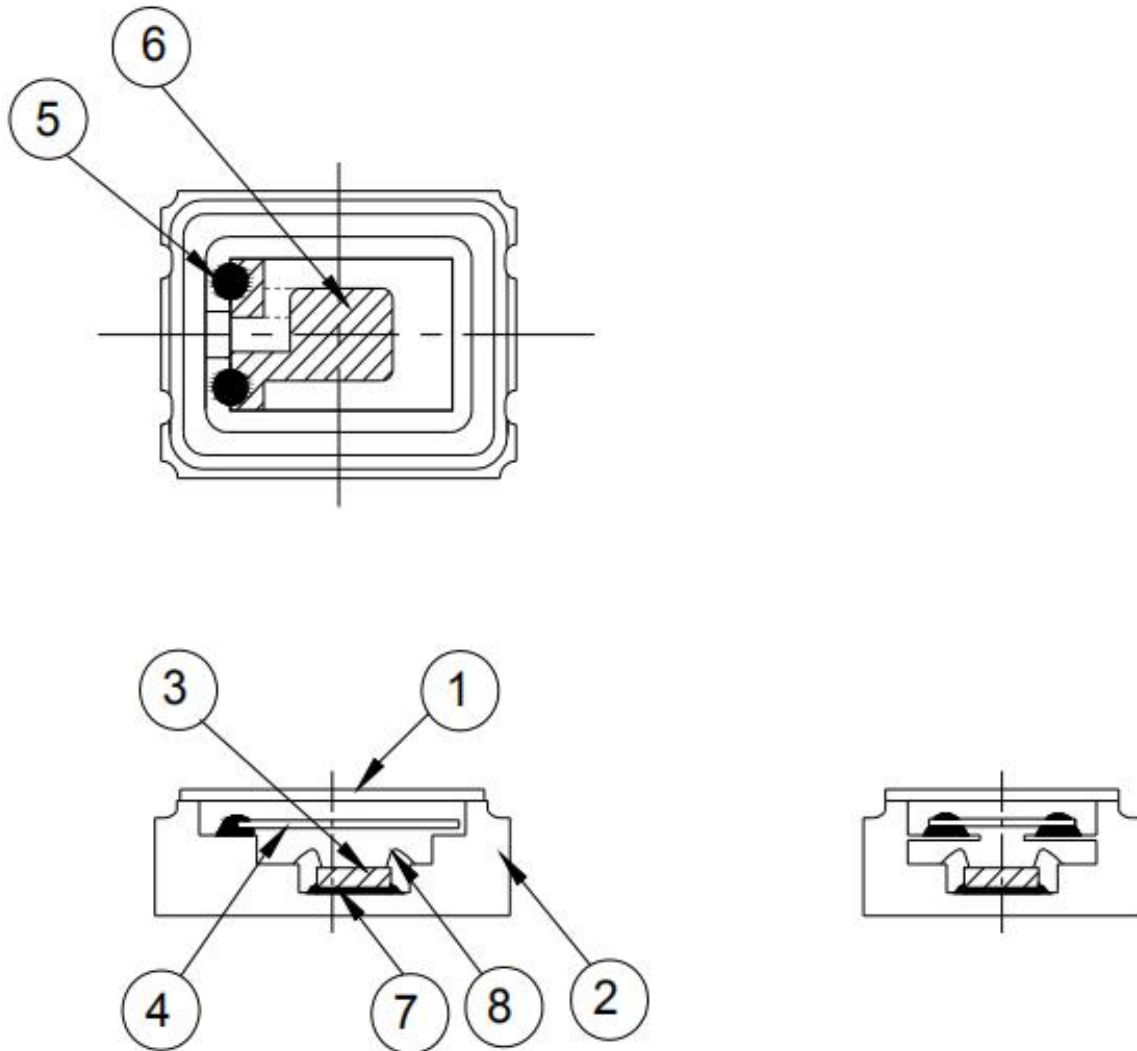

| NO | COMPONENTS          | MATERIA<br>LS   | FINISH/SPECIFICATIONS                             |
|----|---------------------|---|---|
| 1  | Lid                 | Kovar (Fe/Co/Ni)  | -   |
| 2  | Base (Package)      | Ceramic (Al <sub>2</sub> O <sub>3</sub> ) + Kovar (Fe/Co/Ni)+Pad (Au) | -   |
| 3  | IC chip             | -   | -   |
| 4  | Crystal blank       | SiO <sub>2</sub>  | -   |
| 5  | Conductive adhesive | Ag  | Silicon resin                                     |
| 6  | Electrode           | Noble Metal   | -   |
| 7  | Die attached        | Conductive (Ag)   | Epoxy resin                                       |
| 8  | Bonding wire        | Au  | Pad 1 options : NC is 5 wires ,<br>EN is 6 wires. |

### PACKAGE INFORMATION

#### ▶ TAPE (CARRIER) DIMENSIONS

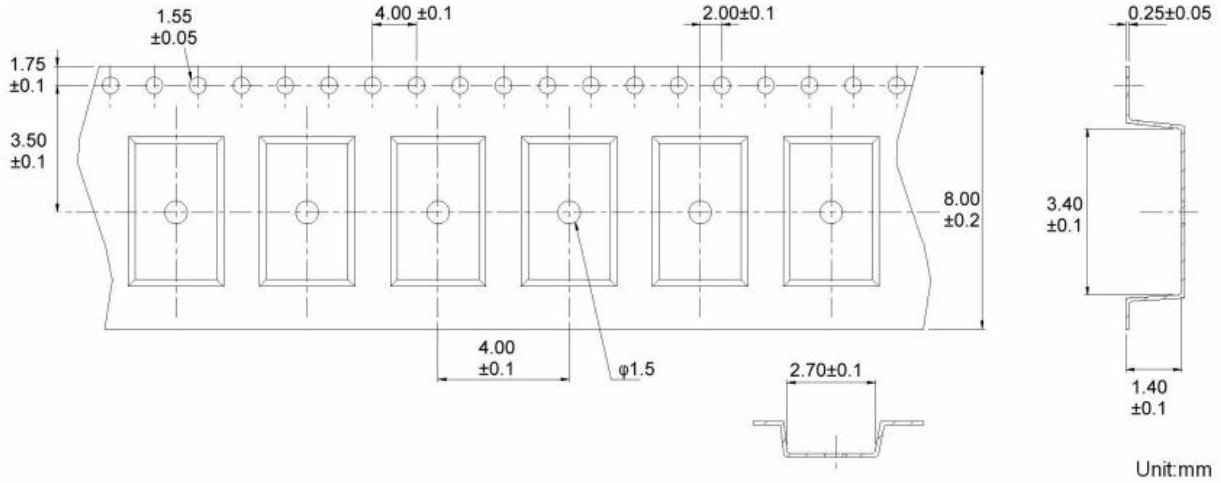

#### ▶ THE DIRECTION OF PACKING

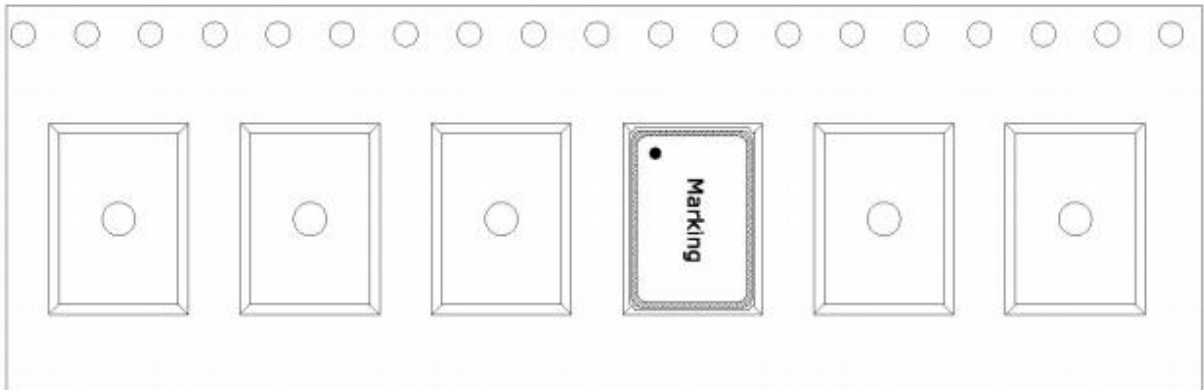

#### ▶ REEL DIMENSIONS

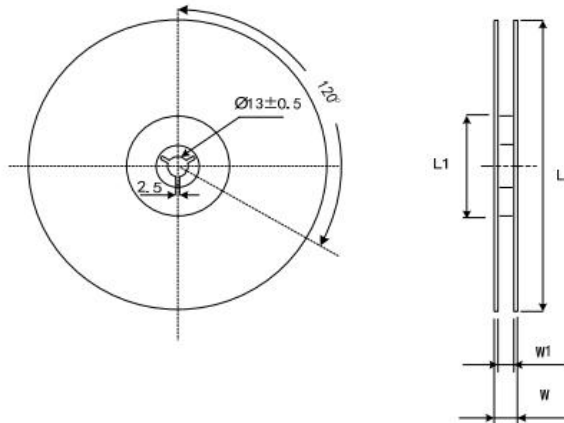

| DIMENSIONS | L     | L1    | W    | W1    | Standard Reel Quantity is 3,000 pcs per reel<br>(UNIT:mm) |
|------------|-------|-------|------|-------|---|
|            | 178   | 60.2  | 11.5 | 8     |   |
|            | ±1.00 | ±0.50 | ±0.2 | +1/-0 |   |

■ RELIABILITY SPECIFICATIONS

1. Mechanical Endurance

| No. | Test Item        | Test Methods  | REF. DOC    |
|-----|------------------|---|-------------|
| 1   | Drop Test        | 75 cm height, 3 times on concrete floor .   | JIS C6701   |
| 1   | Mechanical Shock | Device are shocked to half sine wave ( 1000 G ) three mutually perpendicular axes each 3 times. 0.5m sec. duration time                               | MIL-STD-202 |
| 1   | Vibration        | Frequency range 10 ~ 2000 Hz<br>Amplitude 1.52 mm/20G<br>Sweep time 20 minutes<br>perpendicular axes each test time 4 Hrs<br>(Total test time 12 Hrs) | MIL-STD-883 |
| 1   | Gross Leak       | Standard Sample For Automatic Gross Leak Detector, Test Pressure: 2kg / cm <sup>2</sup>   | MIL-STD-883 |
| 2   | Fine Leak        | Helium Bomging 4.5 kgf / cm <sup>2</sup> for 2 Hrs  | MIL-STD-883 |
| 2   | Solderability    | Temperature 245 °C ± 5°C<br>Immersing depth 0.5 mm minimum<br>Immersion time 5 ± 1 seconds<br>Flux Rosin resin methyl alcohol solvent ( 1 : 4 )       | MIL-STD-883 |

2. Environmental Endurance

| No. | Test Item                    | Test Methods   | REF. DOC    |
|-----|------------------------------|--|-------------|
| 2   | Resistance To Soldering Heat | Pre-heat temperature 125 °C<br>Pre-heat time 60 ~ 120 sec.<br>Test temperature 260 ± 5 °C<br>Test time 10 ± 1 sec.                         | MIL-STD-202 |
| 2   | High Temp. Storage           | + 125 °C ± 3 °C for 1000 ± 12 Hrs  | MIL-STD-883 |
| 2   | Low Temp. Storage            | - 40 °C ± 3 °C for 1000 ± 12 Hrs   |             |
| 2   | Thermal Shock                | Total 100 cycles of the following temperature cycle<br> | MIL-STD-883 |
| 3   | High Temp & Humidity         | 85°C ± 3°C, RH 85% , 1000 Hrs  | EIA-JESD22  |
| 3   | Pressure Cooker Storage      | 121 ± 3°C , RH100% , 2 bar , 240 Hrs   | EIA-JESD22  |

单击下面可查看定价，库存，交付和生命周期等信息

[>>JGHC\(晶光华\)](#)