



# 承 认 书

SPECIFICATION FOR APPROVAL

客户名称: Customer \_\_\_\_\_

货 名: Description SMD 3225 XO CMOS 石英晶体振荡器

客户料号: Part No \_\_\_\_\_

物料编号: Code No O3227000153325

频 率: Frequency 27.000MHz

日 期: Date 2020-05-25

备 注: RoHS compliance with Directive (EU) 2015/863

制作(Prepare by)	检查(Check by)	批准 (Approve by)
江丹娜	甘瑛	张刚

客户批准 Approve by customer	
批准日期 Approval date	

Add:广东省深圳市华发北路桑达工业区桑达雅苑 7P

7 P Sangda Yayuan Huafa North Road, Futian District, Shenzhen, Guangdong

Tel: 86-755-83048260      86-755-83048290

Fax: 86-755-83048280

## ■ ELECTRICAL SPECIFICATIONS

### Standard atmospheric conditions

Unless otherwise specified, the standard range of atmospheric conditions for making measurement and tests are as follow:

Ambient temperature : 25±5℃

Relative humidity : 40%~70%

If there is any doubt about the results, measurement shall be made within the following limits:

Ambient temperature : 25±3℃

Relative humidity : 40%~70%

### Measure equipment

Electrical characteristics measured by MD 37WX-05M or equivalent.

### Crystal cutting type

The crystal is using AT CUT (thickness shear mode).

## ■ Electrical characteristics

### Frequency

	Parameters	Symbol	Electrical Spec.				Notes
			Min.	Typ.	Max.	Units	
1	Nominal Frequency	-	27.000			MHz	-
2	Frequency Stability	-	±25			ppm	-
3	Operating Temperature	Topr	-40	25	85	℃	-
4	Storage Temperature	Tstg	-55	~	125	℃	-
5	Supply Voltage	VDD	3.3 ±10%			V	-
6	Input Current	Icc	-	-	3	mA	-
7	Enable Control	-	Yes			-	Pad 1
8	Output Load : CMOS	CL	15			pF	-
9	Output Voltage High	VoH	90%Vdd	-	-	V	-
10	Output Voltage Low	VoL	-	-	10%Vdd	V	-
11	Rise Time	Tr	-	-	10	ns	10%→90%VDD Level
12	Fall Time	Tf	-	-	10	ns	90%→10%VDD Level
13	Symmetry (Duty ratio)	TH/T	45	~	55	%	-
14	Start-up Time	Tosc	-	-	10	ms	-
15	Enable Voltage High	Vhi	70%Vdd	-	-	V	-
16	Disable Voltage Low	Vlo	-	-	30%Vdd	V	-
17	Aging	-	±3			ppm/yr.	1st. Year at 25℃
18	Output Disable Delay Time	T off	-	-	150	μS	-
19	Output Enable Delay Time	T on	-	-	150	μS	-

### TEST DIAGRAM

Control input (output enable/disable)

Logic 1 or open on pad 1: Oscillator output

Logic 0 on pad 1 : Disable output to high impedance



### WAVEFORM CONDITIONS

Waveform measurement system

should have a min. bandwidth of 5

times the frequency being tested.



■ SUGGESTED REFLOW PROFILE

Total time : 200 sec. Max.

Solder melting point :220 °C

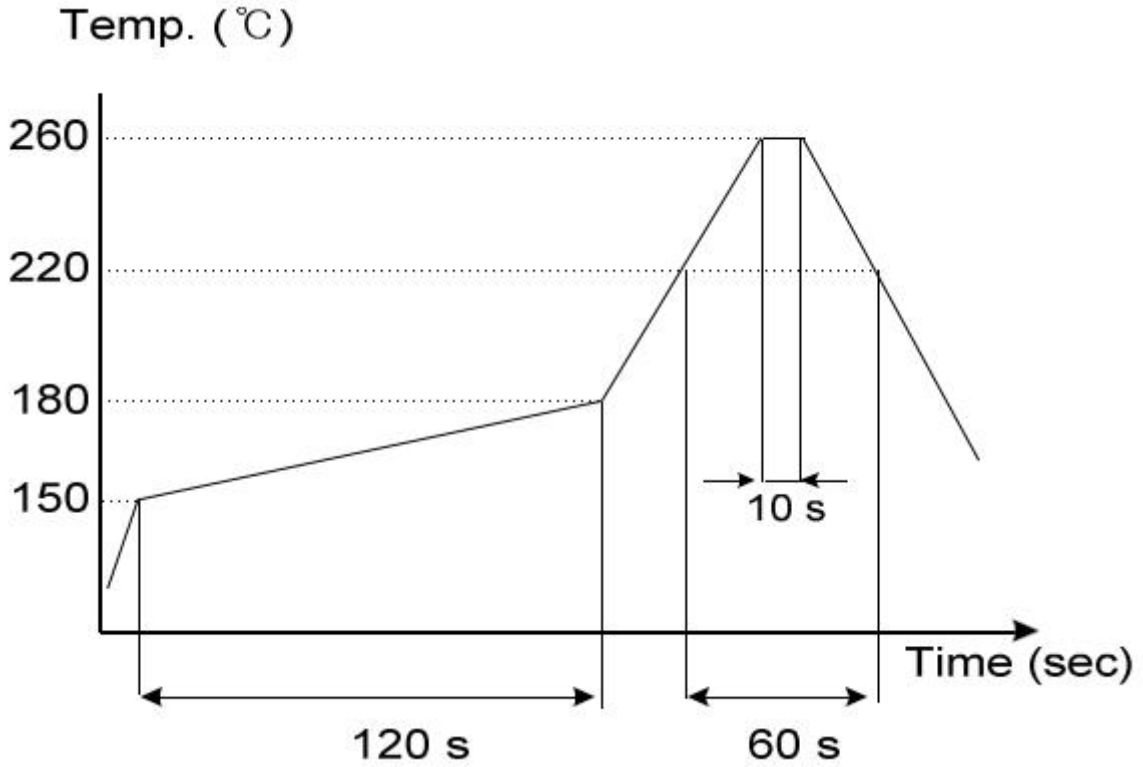

■ PRODUCT DIMENSIONS

(Unit:mm)

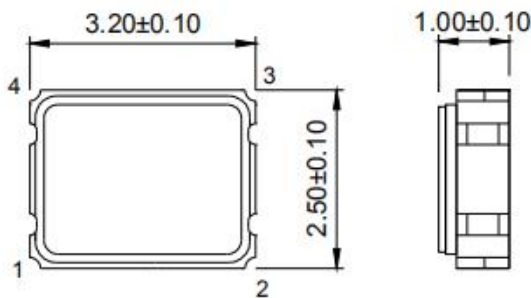

PAD FUNCTION:

- 1: ENABLE CONTROL
- 2: GND
- 3: OUT
- 4: VDD

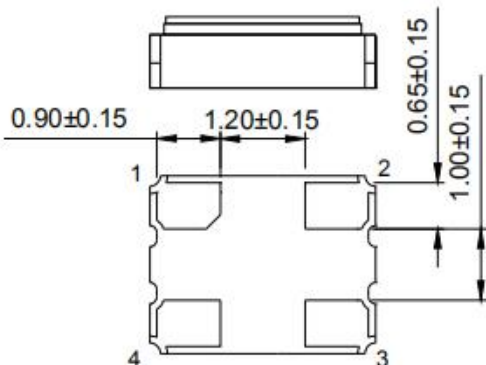

Suggested Layout

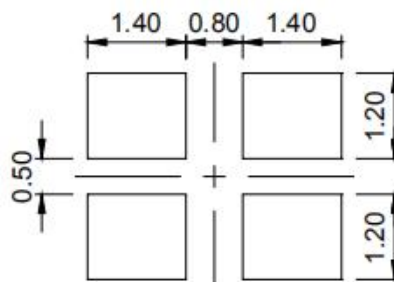

■ STRUCTURE ILLUSTRATION

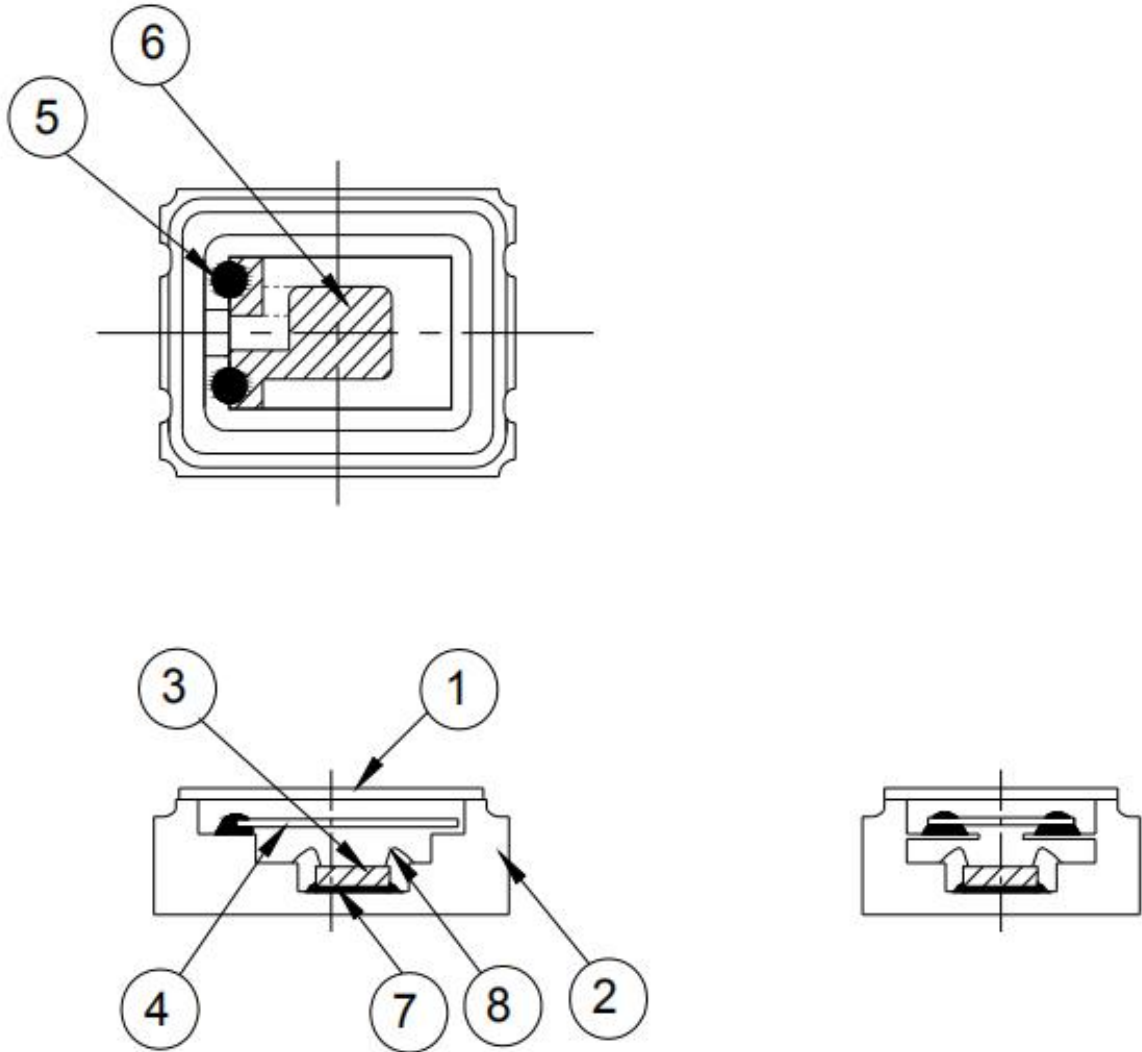

NO	COMPONENTS	MATERIA LS	FINISH/SPECIFICATIONS
1	Lid	Kovar (Fe/Co/Ni)	-
2	Base (Package)	Ceramic (Al <sub>2</sub> O <sub>3</sub> ) + Kovar (Fe/Co/Ni)+Pad (Au)	-
3	IC chip	-	-
4	Crystal blank	SiO <sub>2</sub>	-
5	Conductive adhesive	Ag	Silicon resin
6	Electrode	Noble Metal	-
7	Die attached	Conductive (Ag)	Epoxy resin
8	Bonding wire	Au	Pad 1 options : NC is 5 wires , EN is 6 wires.

■ PACKAGE INFORMATION

▶ TAPE (CARRIER) DIMENSIONS

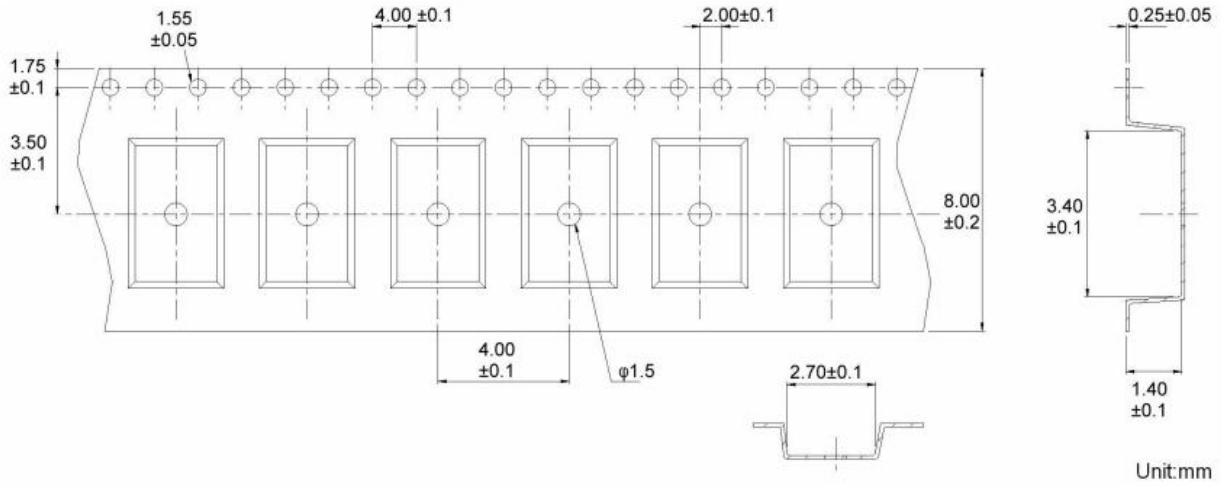

▶ THE DIRECTION OF PACKING

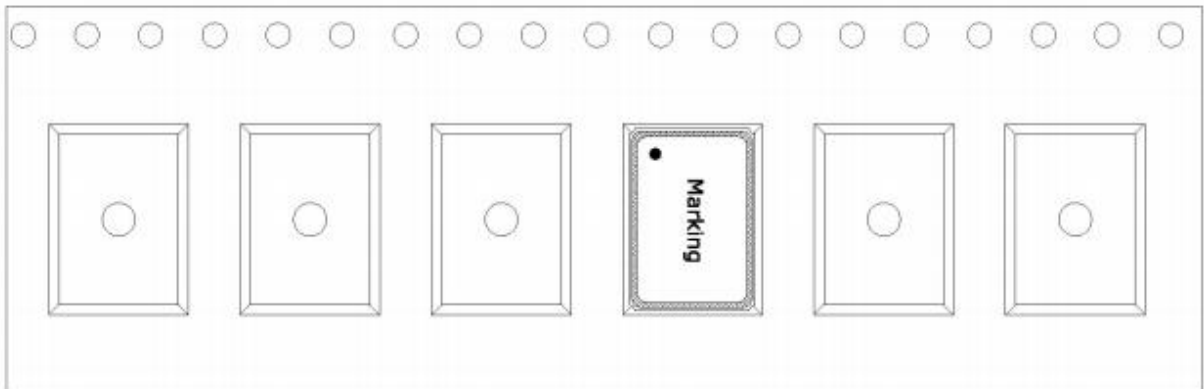

▶ REEL DIMENSIONS

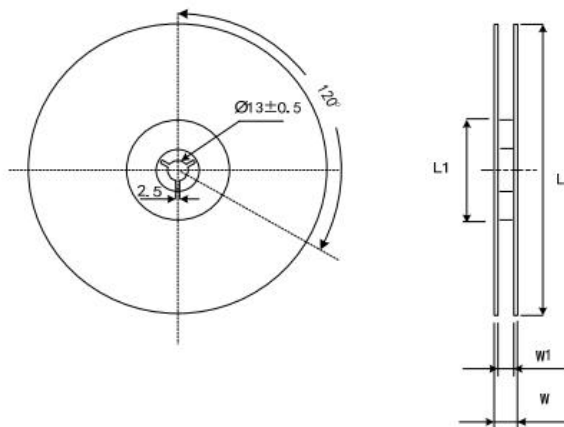

DIMENSIONS	L	L1	W	W1	Standard Reel Quantity is 3,000 pcs per reel (UNIT:mm)
	178 ±1.00	60.2 ±0.50	11.5 ±0.2	8 +1/-0	

■ RELIABILITY SPECIFICATIONS

1. Mechanical Endurance

No.	Test Item	Test Methods	REF. DOC
1	Drop Test	75 cm height, 3 times on concrete floor .	JIS C6701
1	Mechanical Shock	Device are shocked to half sine wave ( 1000 G ) three mutually perpendicular axes each 3 times. 0.5m sec. duration time	MIL-STD-202
1	Vibration	Frequency range 10 ~ 2000 Hz Amplitude 1.52 mm/20G Sweep time 20 minutes perpendicular axes each test time 4 Hrs (Total test time 12 Hrs)	MIL-STD-883
1	Gross Leak	Standard Sample For Automatic Gross Leak Detector, Test Pressure: 2kg / cm <sup>2</sup>	MIL-STD-883
2	Fine Leak	Helium Bomging 4.5 kgf / cm <sup>2</sup> for 2 Hrs	MIL-STD-883
2	Solderability	Temperature 245 °C ± 5°C Immersing depth 0.5 mm minimum Immersion time 5 ± 1 seconds Flux Rosin resin methyl alcohol solvent ( 1 : 4 )	MIL-STD-883

2. Environmental Endurance

No.	Test Item	Test Methods	REF. DOC
2	Resistance To Soldering Heat	Pre-heat temperature 125 °C Pre-heat time 60 ~ 120 sec. Test temperature 260 ± 5 °C Test time 10 ± 1 sec.	MIL-STD-202
2	High Temp. Storage	+ 125 °C ± 3 °C for 1000 ± 12 Hrs	MIL-STD-883
2	Low Temp. Storage	- 40 °C ± 3 °C for 1000 ± 12 Hrs	
2	Thermal Shock	Total 100 cycles of the following temperature cycle 	MIL-STD-883
3	High Temp & Humidity	85°C ± 3°C, RH 85% , 1000 Hrs	EIA-JESD22
3	Pressure Cooker Storage	121 ± 3°C , RH100% , 2 bar , 240 Hrs	EIA-JESD22

单击下面可查看定价，库存，交付和生命周期等信息

[>>JGHC\(晶光华\)](#)