

承 认 书

SPECIFICATION FOR APPROVAL

客户名称: Customer _____

货 名: Description SMD2520 石英晶体谐振器

客户料号: Part No _____

物料编号: Code No S2240000091050JY

频 率: Frequency 40.000MHz

日 期: Date 2020-06-11

备 注: RoHS compliance with Directive (EU) 2015/863

制作(Prepare by)	检查(Check by)	批准 (Approve by)
江丹娜	甘瑛	张刚

客户批准 Approve by customer	
批准日期 Approval date	

Add:广东省深圳市华发北路桑达工业区桑达雅苑 7P

7 P Sangda Yayuan Huafa North Road, Futian District, Shenzhen, Guangdong

Tel: 86-755-83048260 86-755-83048290

Fax: 86-755-83048280

1、 Specifications

1	规格型号 Holder Type	SMD2520
2	标称频率 Nominal Frequency	40.000 MHz
3	振动模式 Mode of Oscillation	Fundamental
4	调整频差 Frequency Tolerance at 25℃	±10ppm
5	温度频差 Temperature Frequency Stability	±30ppm
6	工作温度 Operating Temperature Range	-40~85℃
7	贮存温度 Storage Temperature Range	-40~90℃
8	负载电容 Load Capacitance	9 pF
9	静电容 Shunt capacitance	≤7 pF
10	等效电阻 Equivalent Series Resistance	50 Ω Max
11	激励功率 Drive Level	10uW
12	绝缘阻抗 Insulation Resistance	500MΩ/100V±15V _{DC}
13	年老化率 Aging	±3ppm/First year
14	测试仪器 Test machine	250B

2. Frequency stability over temperature range (AT cut)

Temperature Range	Frequency Stability							
	±3PPM	±5PPM	±7.5PPM	±10PPM	±20PPM	±30PPM	±50PPM	±70PPM
0℃~+50℃	☆	☆	☆	☆	☆	☆	☆	☆
-10℃~+60℃			☆	☆	☆	☆	☆	☆
-20℃~+70℃				☆	☆	☆	☆	☆
-30℃~+70℃					☆	☆	☆	☆
-40℃~+85℃						☆	☆	☆
-40℃~+125℃						☆	☆	☆

3. Dimensions (unit:mm)

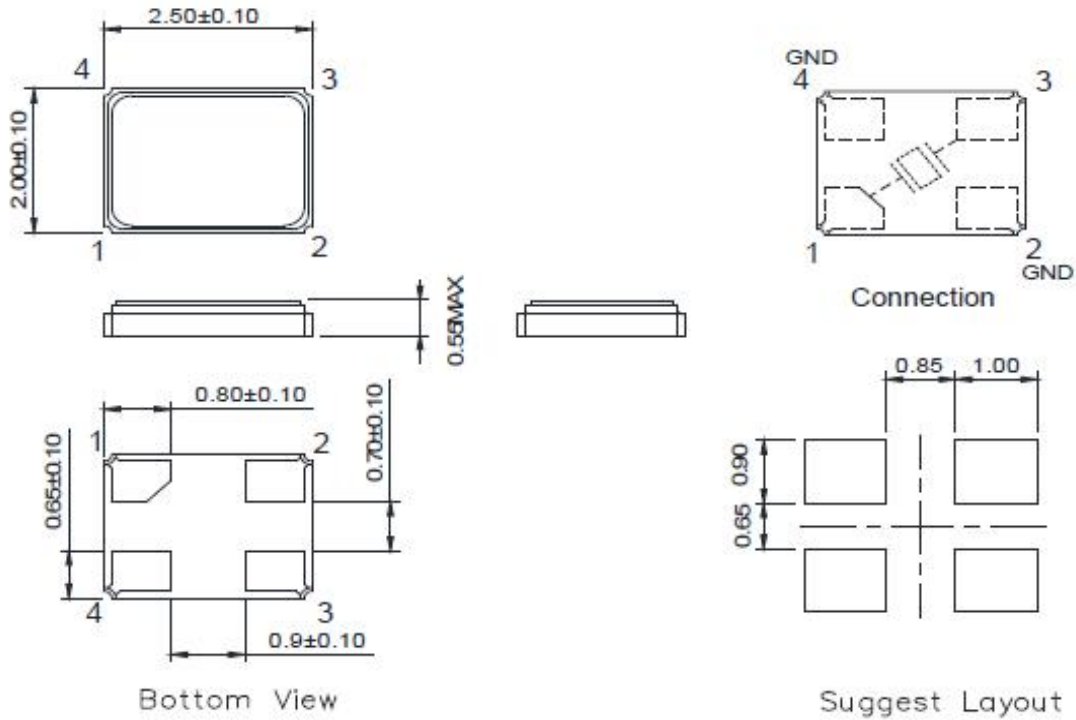

4. Recommended Reflow profile

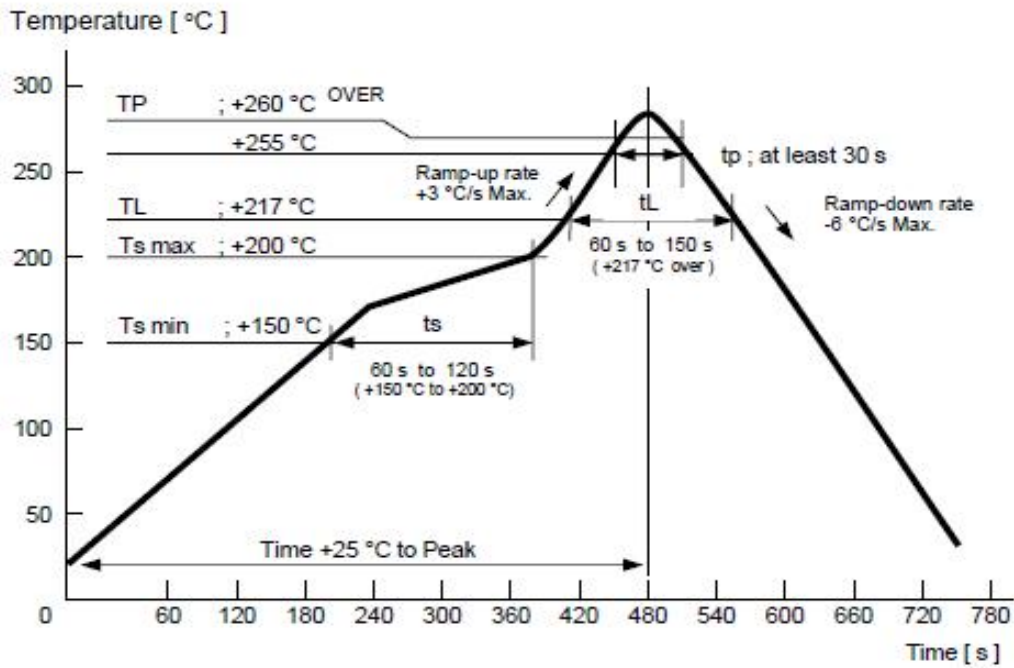

5、Reliability specifications

NO	Item	Condition	Standard
1.	Drop Test	Free drop from 50cm height on a hard wooden board for 3 times. (Board is thickness more than 30 mm.)	Frequency change: ≤5ppm Rr as specification
2.	Mechanical Shock	Half sine wave, 1000G, 0.5mS, three times for all 3 directions	Frequency change: ≤5ppm Rr as specification
3.	Vibration	Frequency range:10~55hz Amplitude:1.52mm Sweep time:1mintutes perpendicular axes each test time:2Hrs	Frequency change: ≤5ppm Rr as specification
4.	Solderability	Temperature:245℃±5℃ Immersing depth:0.5mm minimum Immersion time:5±1sec. Flux:Rosin resin methyl alcohol solvent(1:4)	90% exhibit tin ok
5.	Resistance to soldering heat	Test temperature:260℃±5℃ Test time :10±1sec.	Frequency change: ≤10ppm Rr as specification
6.	High Temp & Humidity	85±3℃ & RH85%, 500±12 hours	Frequency change: ≤10ppm Rr as specification
7.	Low temperature storage	-40±3℃, 500±12 hours	Frequency change: ≤10ppm Rr as specification
8.	High temperature storage	+85±3℃, 500±12 hours	Frequency change: ≤10ppm Rr as specification
9.	Temperature cycling	-40±3℃/10min~+85±3℃/10min, 100cycles	Frequency change: ≤10ppm Rr as specification

6、Packaging standard

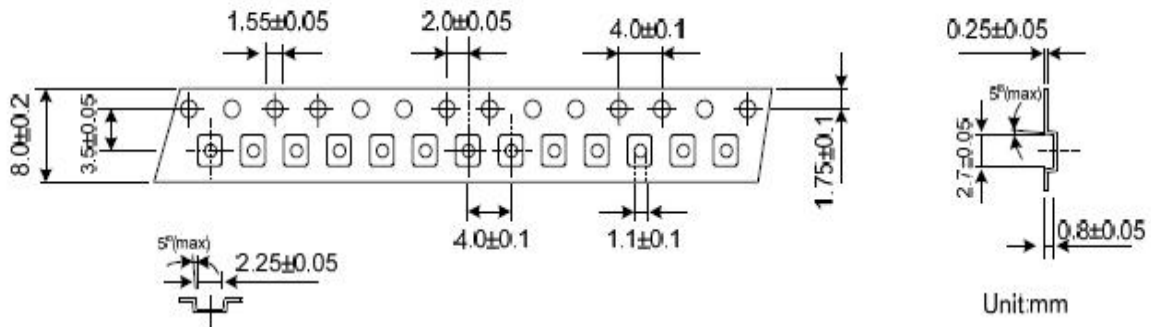

REMARK :

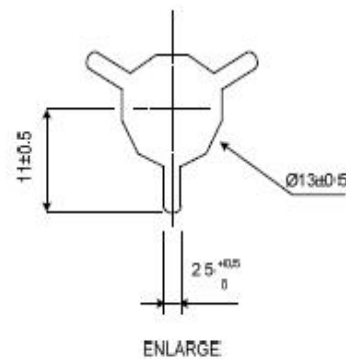
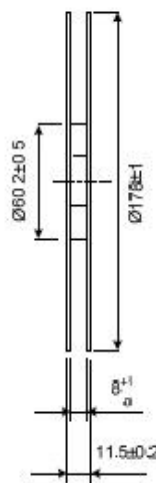
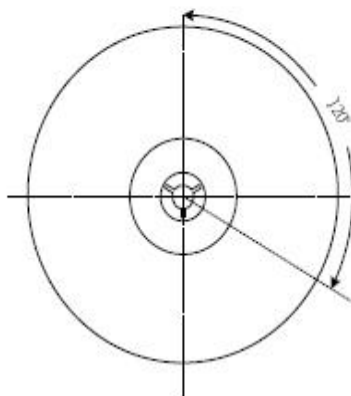
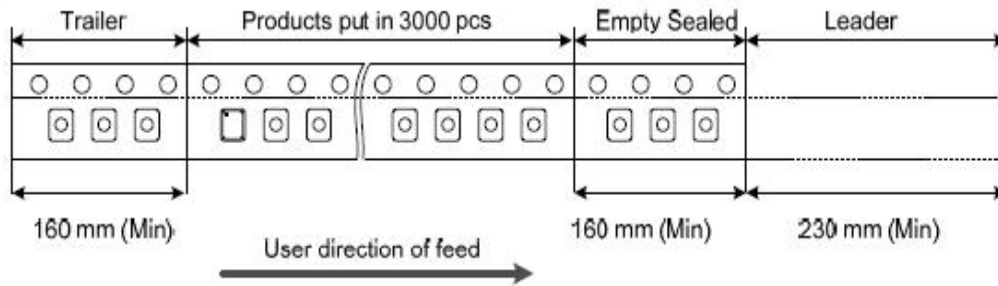

7. Inner carton

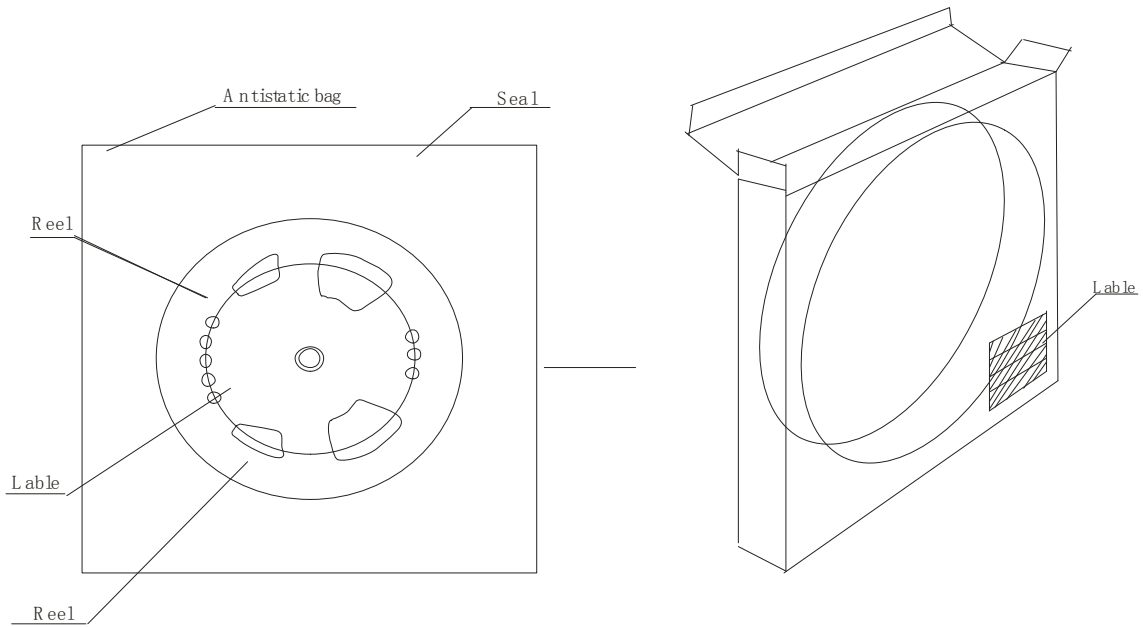

OUTET CARTON

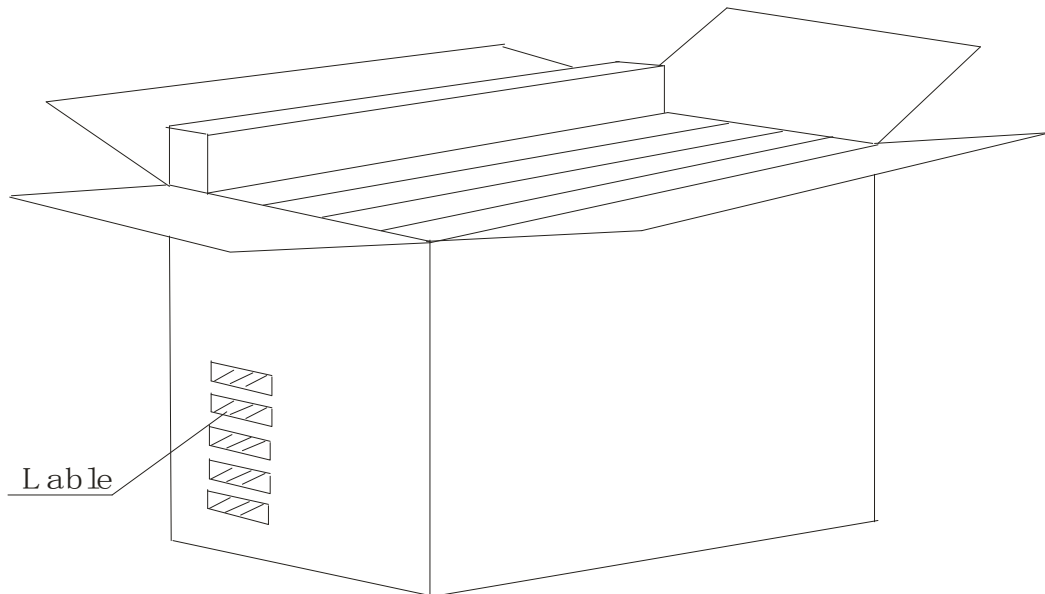

7-1. MARKING

- (1) Marking Labels are affixed to reel, inner carton and outer carton.
- (2) Each label contains the following information.
 - (a) Manufacture's name or symbol
 - (b) Parts name or type
 - (c) Frequency
 - (d) Quantity
 - (e) Reel number
 - (f) Manufacturer's code (EIAJ code)

7-2. QUANTITY

3000pcs/reel (max.5reels in outer carton)

7-3. STORAGE ENVIRONMENT

- ✧ Storage the reel at normal temperature and humidity
- ✧ Open the packing just before using
- ✧ Do not expose the sun
- ✧ Do not storage with some erosive chemicals
- ✧ Nothing is allowed to put on the reel or carton to prevent mechanical damage

7-4. HANDLING

- ✧ Handle with care to prevent the damage of tape, reel and products.

单击下面可查看定价，库存，交付和生命周期等信息

[>>JGHC\(晶光华\)](#)