

## Surface Mount Superfast Recovery Rectifier

Reverse Voltage – 50 to 600 V

Forward Current – 1 A

### FEATURES

- For surface mounted applications
- Low profile package
- Glass Passivated Chip Junction
- Superfast reverse recovery time
- Lead free in comply with EU RoHS 2011/65/EU directives

### MECHANICAL DATA

- Case: SMA
- Terminals: Solderable per MIL-STD-750, Method 2026
- Approx. Weight: 0.055g / 0.002oz

### PINNING

| PIN | DESCRIPTION |
|-----|-------------|
| 1   | Cathode     |
| 2   | Anode       |

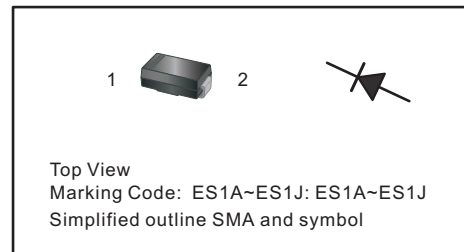

### Absolute Maximum Ratings and Characteristics

Ratings at 25 °C ambient temperature unless otherwise specified. Single phase, half wave, 60 Hz, resistive or inductive load. For capacitive load, derate current by 20%.

| Parameter  | Symbols         | ES1A       | ES1B | ES1C | ES1D | ES1E | ES1G | ES1J | Units              |
|--|-----------------|------------|------|------|------|------|------|------|--------------------|
| Maximum Repetitive Peak Reverse Voltage  | $V_{RRM}$       | 50         | 100  | 150  | 200  | 300  | 400  | 600  | V                  |
| Maximum RMS voltage  | $V_{RMS}$       | 35         | 70   | 105  | 140  | 210  | 280  | 420  | V                  |
| Maximum DC Blocking Voltage  | $V_{DC}$        | 50         | 100  | 150  | 200  | 300  | 400  | 600  | V                  |
| Maximum Average Forward Rectified Current at $T_L = 100\text{ }^\circ\text{C}$   | $I_{F(AV)}$     | 1          |      |      |      |      |      |      | A                  |
| Peak Forward Surge Current 8.3 ms Single Half Sine Wave Superimposed on Rated Load (JEDEC Method)                                | $I_{FSM}$       | 30         |      |      |      |      |      |      | A                  |
| Maximum Forward Voltage at 1 A   | $V_F$           | 1          |      |      |      | 1.25 |      | 1.70 | V                  |
| Maximum DC Reverse Current at Rated DC Blocking Voltage<br>$T_a = 25\text{ }^\circ\text{C}$<br>$T_a = 125\text{ }^\circ\text{C}$ | $I_R$           | 5<br>100   |      |      |      |      |      |      | $\mu\text{A}$      |
| Typical Junction Capacitance at $V_R = 4\text{V}$ , $f = 1\text{MHz}$  | $C_j$           | 15         |      |      |      |      |      |      | pF                 |
| Maximum Reverse Recovery Time <sup>(1)</sup>   | $t_{rr}$        | 35         |      |      |      |      |      |      | ns                 |
| Typical Thermal Resistance <sup>(2)</sup>  | $R_{\theta JA}$ | 110        |      |      |      |      |      |      | $^\circ\text{C/W}$ |
| Operating and Storage Temperature Range  | $T_j, T_{stg}$  | -55 ~ +150 |      |      |      |      |      |      | $^\circ\text{C}$   |

(1) Measured with  $I_F = 0.5\text{ A}$ ,  $I_R = 1\text{ A}$ ,  $I_{rr} = 0.25\text{ A}$ .

(2) P.C.B. mounted with 1.0 X 1.0" (2.54 X 2.54 cm) copper pad areas.



Fig.1 Reverse Recovery Time Characteristic And Test Circuit Diagram

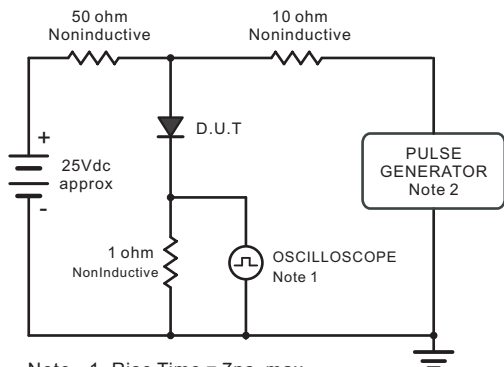

Note: 1. Rise Time = 7ns, max.  
Input Impedance = 1megohm, 22pF.  
2. Rise Time = 10ns, max.  
Source Impedance = 50 ohms.

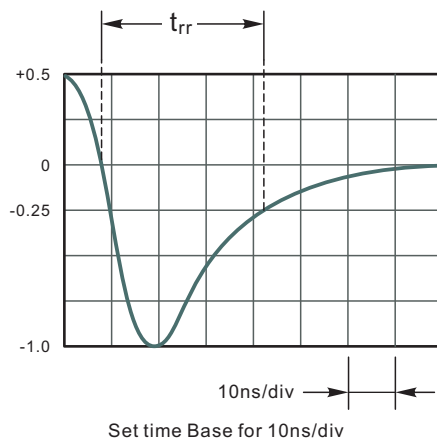

Fig.2 Maximum Average Forward Current Rating

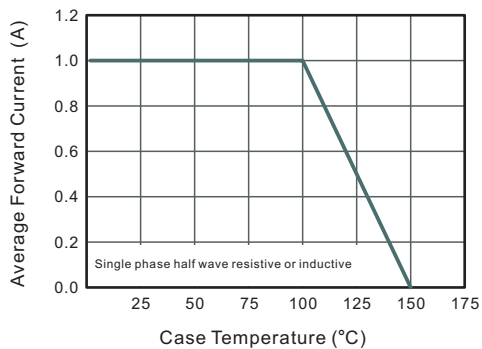

Fig.3 Typical Reverse Characteristics

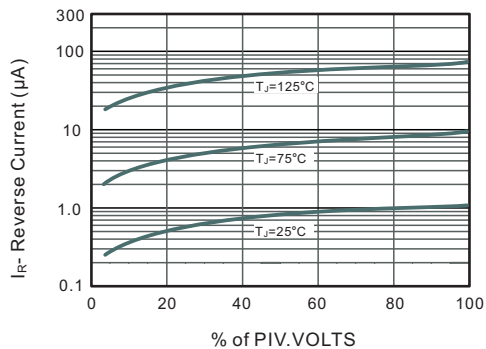

Fig.4 Typical Forward Characteristics

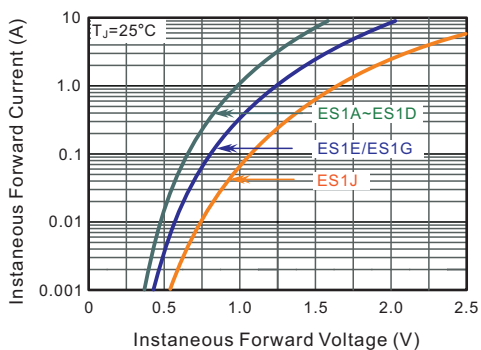

Fig.5 Typical Junction Capacitance

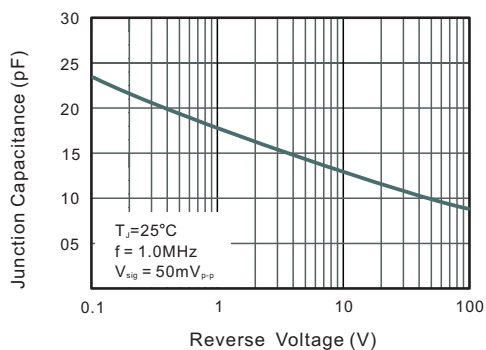
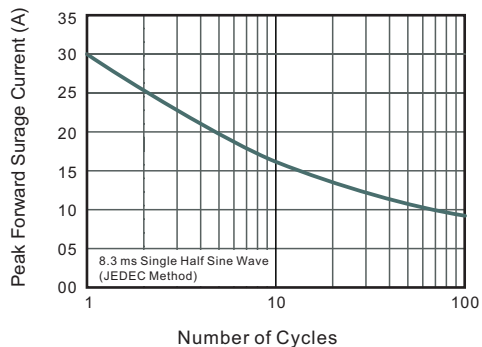

Fig.6 Maximum Non-Repetitive Peak Forward Surge Current





**PACKAGE OUTLINE**

Plastic surface mounted package; 2 leads

SMA

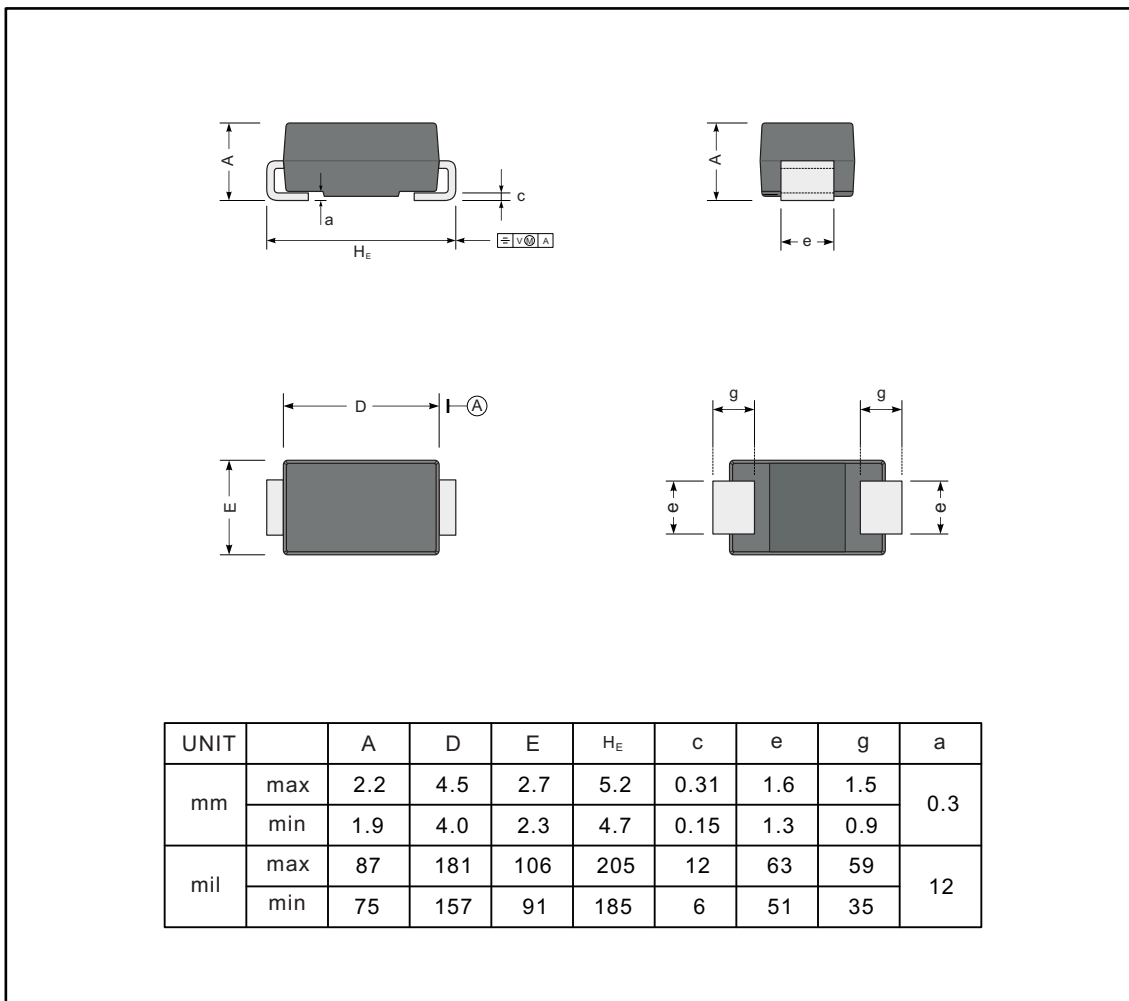

**The recommended mounting pad size**

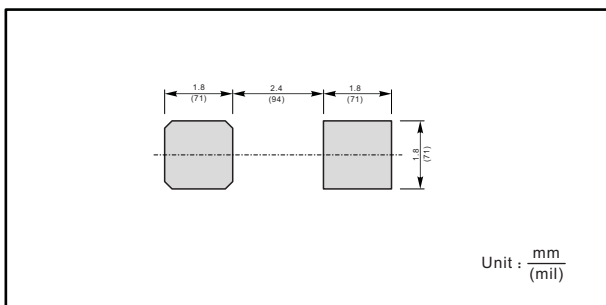

**Marking**

| Type number | Marking code |
|-------------|--------------|
| ES1A        | ES1A         |
| ES1B        | ES1B         |
| ES1C        | ES1C         |
| ES1D        | ES1D         |
| ES1E        | ES1E         |
| ES1G        | ES1G         |
| ES1J        | ES1J         |

单击下面可查看定价，库存，交付和生命周期等信息

[>>JINGDAO\(晶导微\)](#)