



### FEATURES

- For surface mounted applications
- Glass Passivated Chip Junction
- Fast reverse recovery time
- Ideal for automated placement
- Lead free in comply with EU RoHS 2011/65/EU directives

### MECHANICAL DATA

- Case: SOD-323
- Terminals: Solderable per MIL-STD-750, Method 2026
- Approx. Weight: 5.48mg / 0.00019oz

### PINNING

PIN	DESCRIPTION
1	Cathode
2	Anode

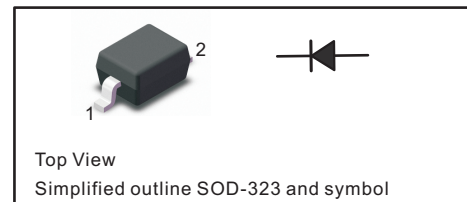

### Absolute Maximum Ratings at 25 °C

Parameter	Symbols	BAV19WS	BAV20WS	BAV21WS	Units
Maximum Repetitive Peak Reverse Voltage	$V_{RRM}$	120	200	250	V
Maximum RMS voltage	$V_{RMS}$	100	150	200	V
Continuous Forward Current	$I_F$	250			mA
Repetitive Peak Forward Current	$I_{FRM}$	625			mA
Non-repetitive Peak Forward Surge Current at 1s at 1ms at 1us	$I_{FSM}$	1 3 9			A
Total Power Dissipation	$P_{tot}$	500			mW
Operating and Storage Temperature Range	$T_j, T_{stg}$	-55 ~ +150			°C

### Characteristics at $T_a = 25\text{ °C}$

Parameter	Symbols	BAV19WS	BAV20WS	BAV21WS	Units
Reverse Breakdown Voltage at $I_R = 100\mu A$	$V_{(BR)R}$	120	200	250	V
Maximum Forward Voltage at 100 mA at 200 mA	$V_F$	1.00 1.25			V
Maximum DC Reverse Current at Rated DC Blocking Voltage $T_a = 25\text{ °C}$ $T_a = 150\text{ °C}$	$I_R$	0.1 100			$\mu A$
Typical Junction Capacitance at $V_R = 4V, f = 1MHz$	$C_j$	5			pF
Maximum Reverse Recovery Time <sup>(1)</sup>	$t_{rr}$	50			ns

( 1 ) Measured with  $I_F = 0.5 A, I_R = 1 A, I_{rr} = 0.25 A$



Fig.1 Power Derating Curve

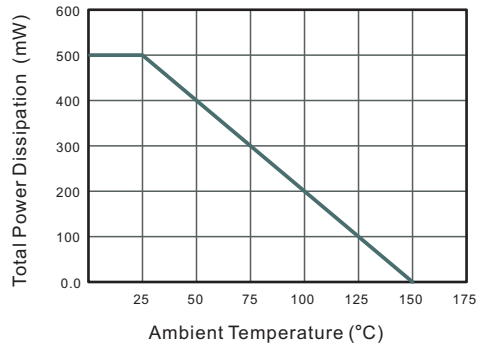

Fig.2 Typical Reverse Characteristics

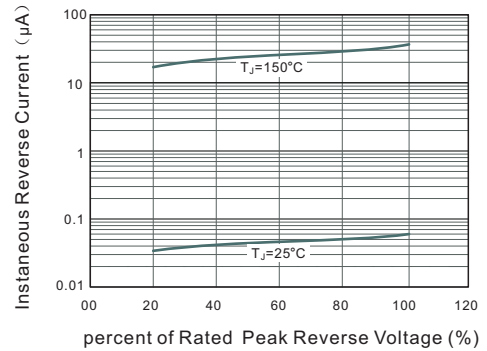

Fig.3 Typical Instantaneous Forward Characteristics

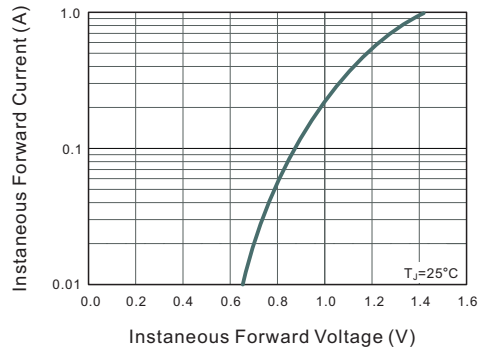
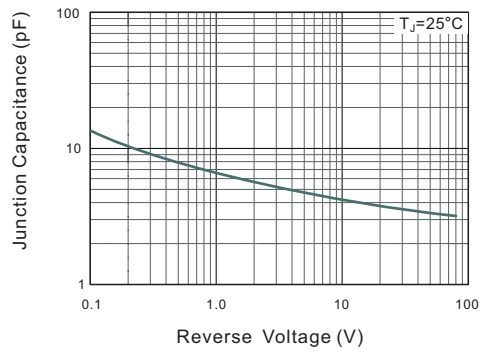

Fig.4 Typical Junction Capacitance





### PACKAGE OUTLINE

Plastic surface mounted package; 2 leads

SOD-323

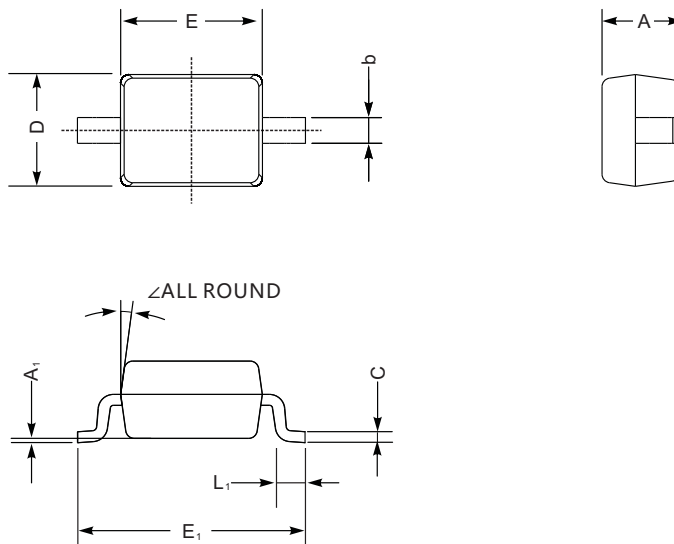

SOD-323 mechanical data

UNIT		A	C	D	E	E <sub>1</sub>	b	L <sub>1</sub>	A <sub>1</sub>	∠
mm	max	1.1	0.15	1.4	1.8	2.75	0.4	0.45	0.2	9°
	min	0.8	0.08	1.2	1.4	2.55	0.25	0.2	—	
mil	max	43	5.9	55	70	108	16	16	8	
	min	32	3.1	47	63	100	9.8	7.9	—	

### The recommended mounting pad size

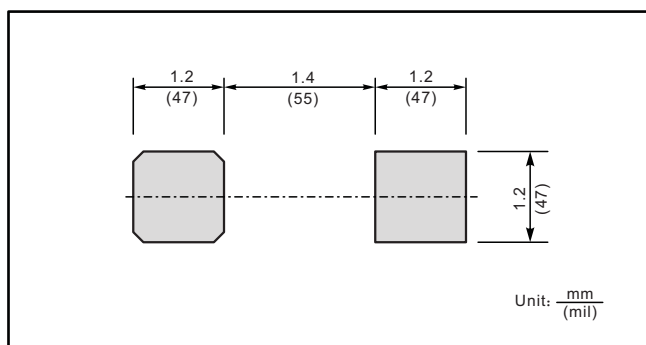

### Marking

Type number	Marking code
BAV19WS	A8
BAV20WS	T2
BAV21WS	T3

单击下面可查看定价，库存，交付和生命周期等信息

[>>JINGDAO\(晶导微\)](#)