



**Surface Mount Schottky Barrier Rectifier**

**Reverse Voltage - 20 to 200 V**

**Forward Current - 3 A**

**FEATURES**

- Metal silicon junction, majority carrier conduction
- For surface mounted applications
- Low power loss, high efficiency
- High forward surge current capability
- For use in low voltage, high frequency inverters, free wheeling, and polarity protection applications

**MECHANICAL DATA**

- Case: SMB
- Terminals: Solderable per MIL-STD-750, Method 2026
- Approx. Weight: 95mg ( 0.0034oz )

**PINNING**

PIN	DESCRIPTION
1	Cathode
2	Anode

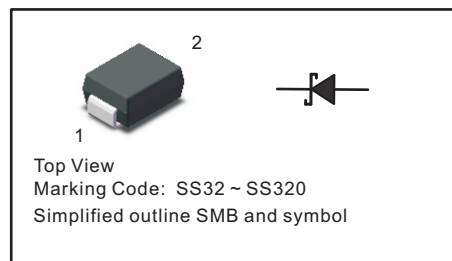

**Maximum Ratings and Electrical characteristics**

Ratings at 25 °C ambient temperature unless otherwise specified.

Single phase half-wave 60 Hz, resistive or inductive load, for capacitive load current derate by 20 %.

Parameter	Symbols	SS32B	SS34B	SS36B	SS38B	SS310B	SS312B	SS315B	SS320B	Units
Maximum Repetitive Peak Reverse Voltage	$V_{RRM}$	20	40	60	80	100	120	150	200	V
Maximum RMS voltage	$V_{RMS}$	14	28	42	56	70	84	105	140	V
Maximum DC Blocking Voltage	$V_{DC}$	20	40	60	80	100	120	150	200	V
Maximum Average Forward Rectified Current	$I_{F(AV)}$	3.0								A
Peak Forward Surge Current, 8.3ms Single Half Sine-wave Superimposed on Rated Load (JEDEC method)	$I_{FSM}$	80								A
Max Instantaneous Forward Voltage at 3 A	$V_F$	0.55	0.70		0.85		0.95		V	
Maximum DC Reverse Current $T_a = 25^\circ\text{C}$ at Rated DC Reverse Voltage $T_a = 100^\circ\text{C}$	$I_R$	0.5 5			0.3 3				mA	
Typical Junction Capacitance <sup>(1)</sup>	$C_j$	450			400				pF	
Typical Thermal Resistance <sup>(2)</sup>	$R_{\theta JA}$	60								°C/W
Operating Junction Temperature Range	$T_j$	-55 ~ +150								°C
Storage Temperature Range	$T_{stg}$	-55 ~ +150								°C

( 1 ) Measured at 1 MHz and applied reverse voltage of 4 V D.C

( 2 ) P.C.B. mounted with 2.0" X 2.0" (5 X 5 cm) copper pad areas.



Fig.1 Forward Current Derating Curve

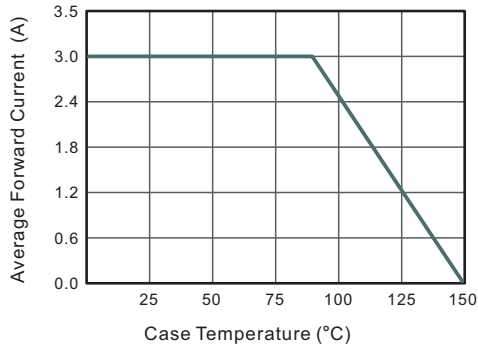

Fig.2 Typical Reverse Characteristics

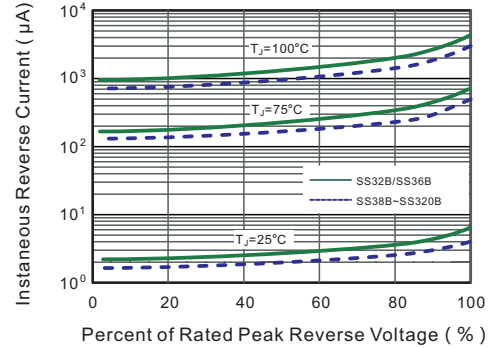

Fig.3 Typical Forward Characteristic

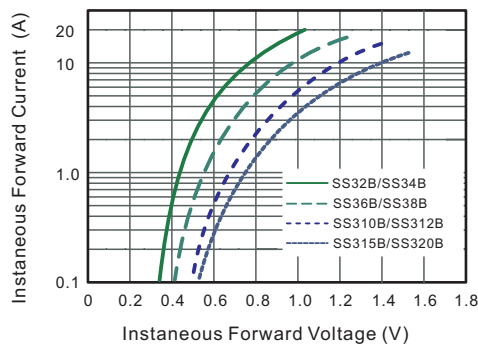

Fig.4 Typical Junction Capacitance

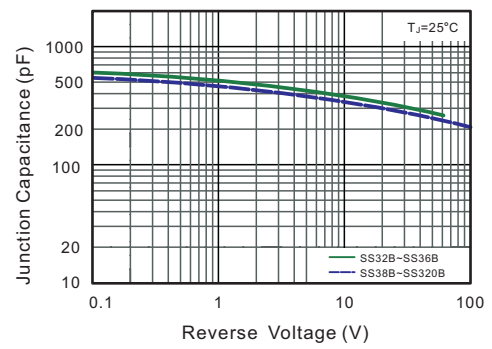

Fig.5 Maximum Non-Repetitive Peak Forward Surge Current

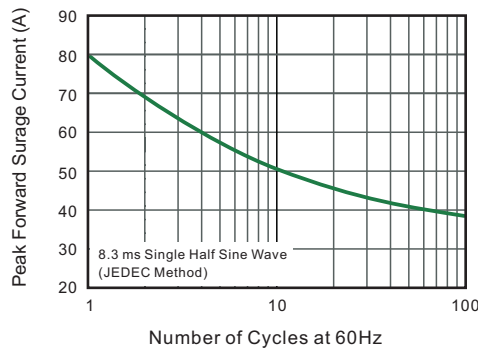
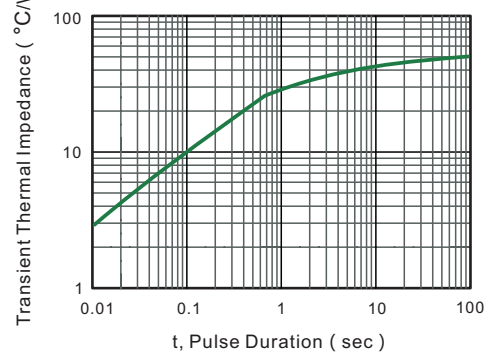

Fig.6- Typical Transient Thermal Impedance





**PACKAGE OUTLINE**

Plastic surface mounted package; 2 leads

SMB

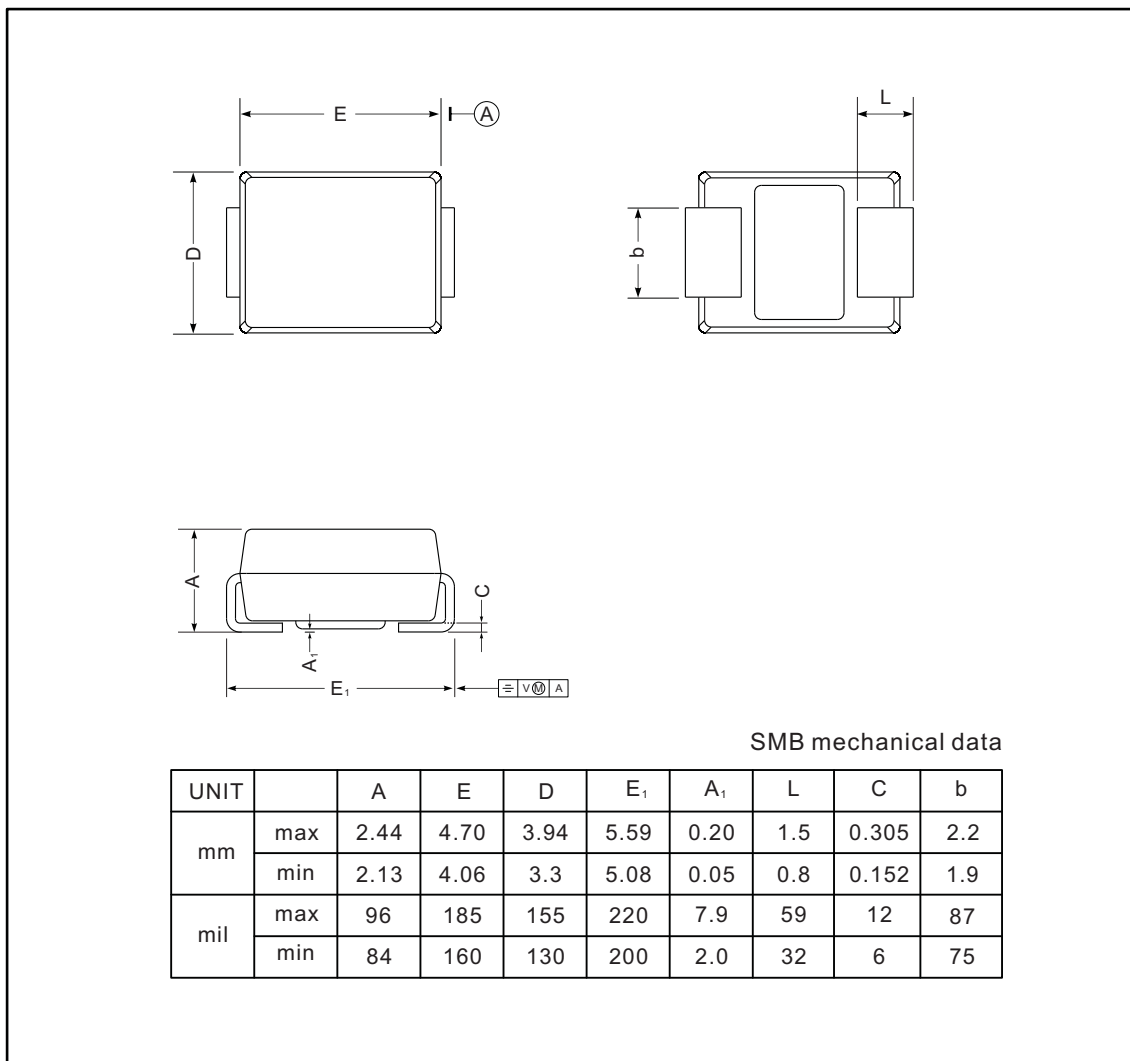

**The recommended mounting pad size**

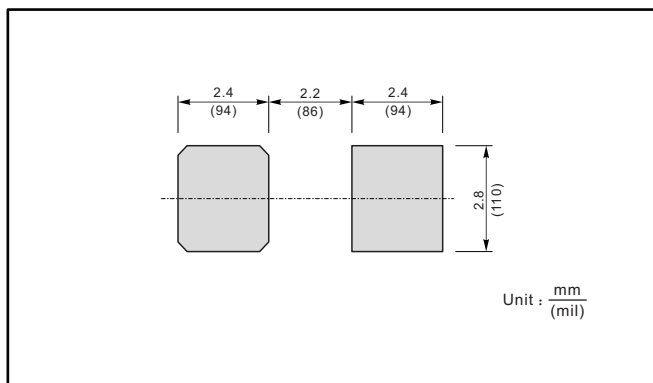

**Marking**

Type number	Marking code
SS32B	SS32
SS34B	SS34
SS36B	SS36
SS38B	SS38
SS310B	SS310
SS312B	SS312
SS315B	SS315
SS320B	SS320

单击下面可查看定价，库存，交付和生命周期等信息

[>>JINGDAO\(晶导微\)](#)