

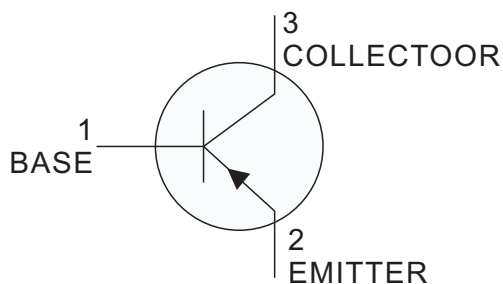

General Purpose Transistor

PNP Silicon

SOT-23

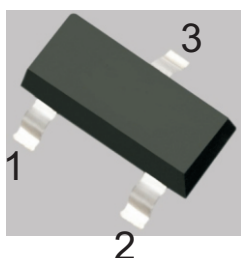

DEVICE MARKING
S9015 = M6

MAXIMUM RATINGS

Rating	Symbol	Value	Unit
Collector–Emitter Voltage	V_{CEO}	-45	Vdc
Collector–Base Voltage	V_{CBO}	-50	Vdc
Emitter–Base Voltage	V_{EBO}	-5.0	Vdc
Collector Current — Continuous	I_C	-100	mAdc

THERMAL CHARACTERISTICS

Characteristic	Symbol	Max	Unit
Total Device Dissipation FR– 5 Board, (1) $T_A = 25^\circ\text{C}$	P_D	200	mW
Junction and Storage Temperature	T_J, T_{stg}	- 55 to +150	$^\circ\text{C}$

ELECTRICAL CHARACTERISTICS ($T_A = 25^\circ\text{C}$ unless otherwise noted.)
OFF CHARACTERISTICS

Characteristic	Symbol	Min	Max	Unit
Collector–Emitter Breakdown Voltage(3) ($I_C = -0.1 \text{ mAdc}$, $I_B = 0$)	$V_{(BR)CEO}$	-45	–	Vdc
Collector–Base Breakdown Voltage ($I_C = -100 \mu\text{Adc}$, $I_E = 0$)	$V_{(BR)CBO}$	-50	–	Vdc
Emitter–Base Breakdown Voltage ($I_E = -100 \mu\text{Adc}$, $I_C = 0$)	$V_{(BR)EBO}$	-5.0	–	Vdc
Collector cut-off current ($V_{CB} = -50 \text{ Vdc}$, $I_E = 0$)	I_{CBO}	–	-0.1	μAdc
Emitter cut-off current ($V_{EB} = -5 \text{ Vdc}$, $I_C = 0$)	I_{EBO}	–	-0.1	μAdc

- FR–5 = 1.0 x 0.75 x 0.062 in.
- Alumina = 0.4 x 0.3 x 0.024 in. 99.5% alumina.
- Pulse Test: Pulse Width <300 μs , Duty Cycle <2.0%.



**ELECTRICAL CHARACTERISTICS (T A = 25°C unless otherwise noted) (Continued)
ON CHARACTERISTICS (3)**

Characteristic	Symbol	Min	Max	Unit
DC Current Gain	h _{FE}			—
(I _c = -1.0 mA _{dc} , V _{CE} = -5 V _{dc})		200	1000	
Collector–Emitter Saturation Voltage	V _{CE(sat)}			V _{dc}
(I _c = -100 mA _{dc} , I _B = -10 mA _{dc})(3)		—	-0.3	
Base–Emitter Saturation Voltage(3)	V _{BE(sat)}			V _{dc}
(I _c = -100 mA _{dc} , I _B = -10mA _{dc})		—	-1.0	

SMALL–SIGNAL CHARACTERISTICS

Current–Gain — Bandwidth Product (I _c = -10mA _{dc} , V _{CE} = -5.0V _{dc} , f = 30MHz)	f _t	150	—	MHz
--	----------------	-----	---	-----

CLASSIFICATION OF h_{FE}

Rank	L	H
Range	200-450	400-1000



TYPICAL CHARACTERISTICS

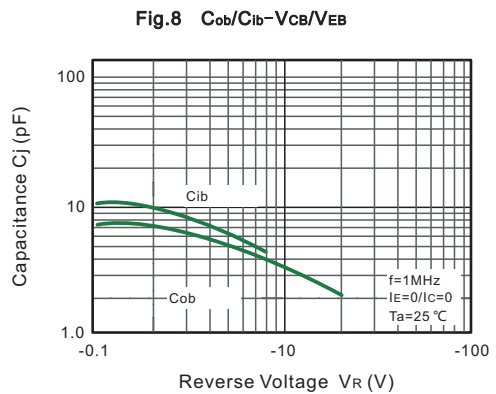
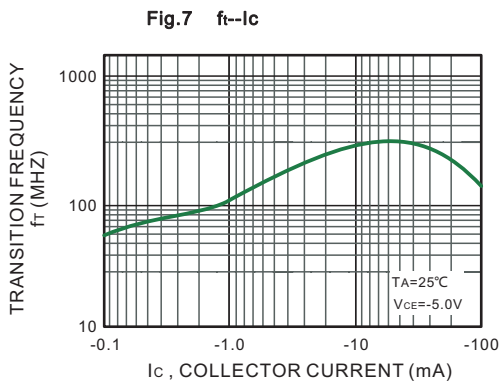
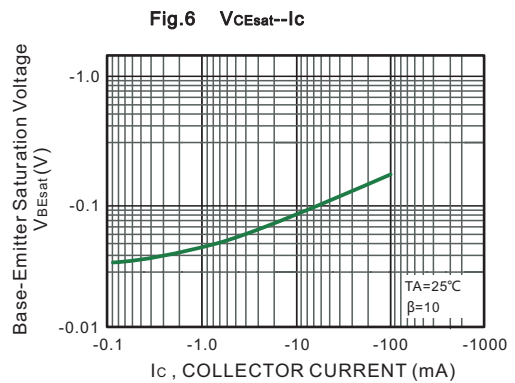
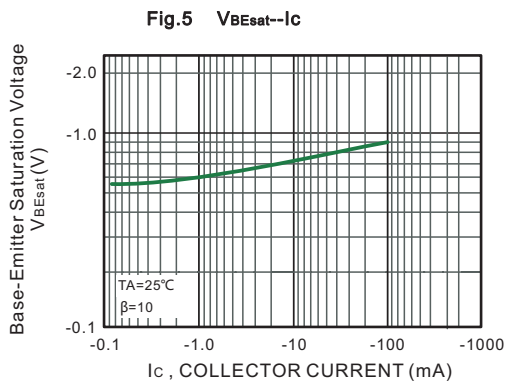
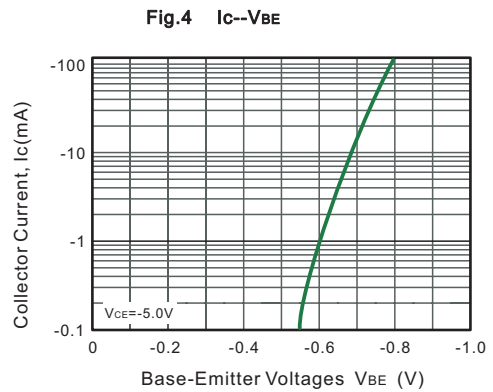
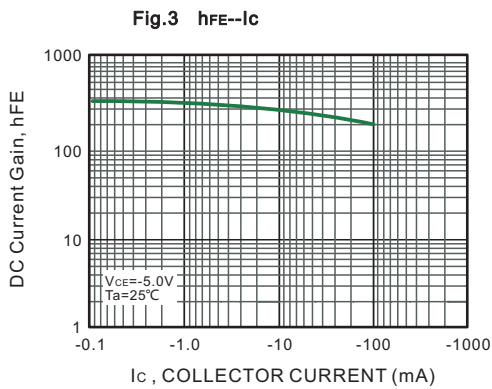
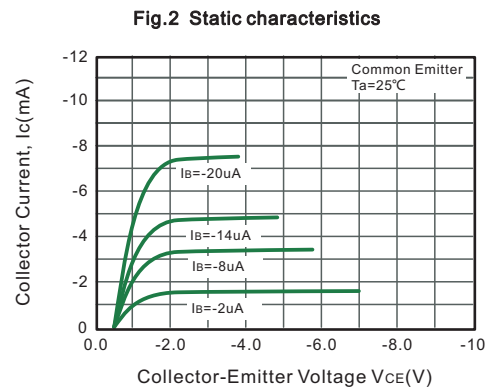
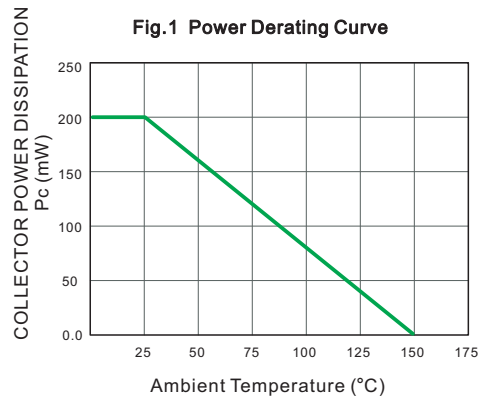



SOT-23 Package Outline Dimensions

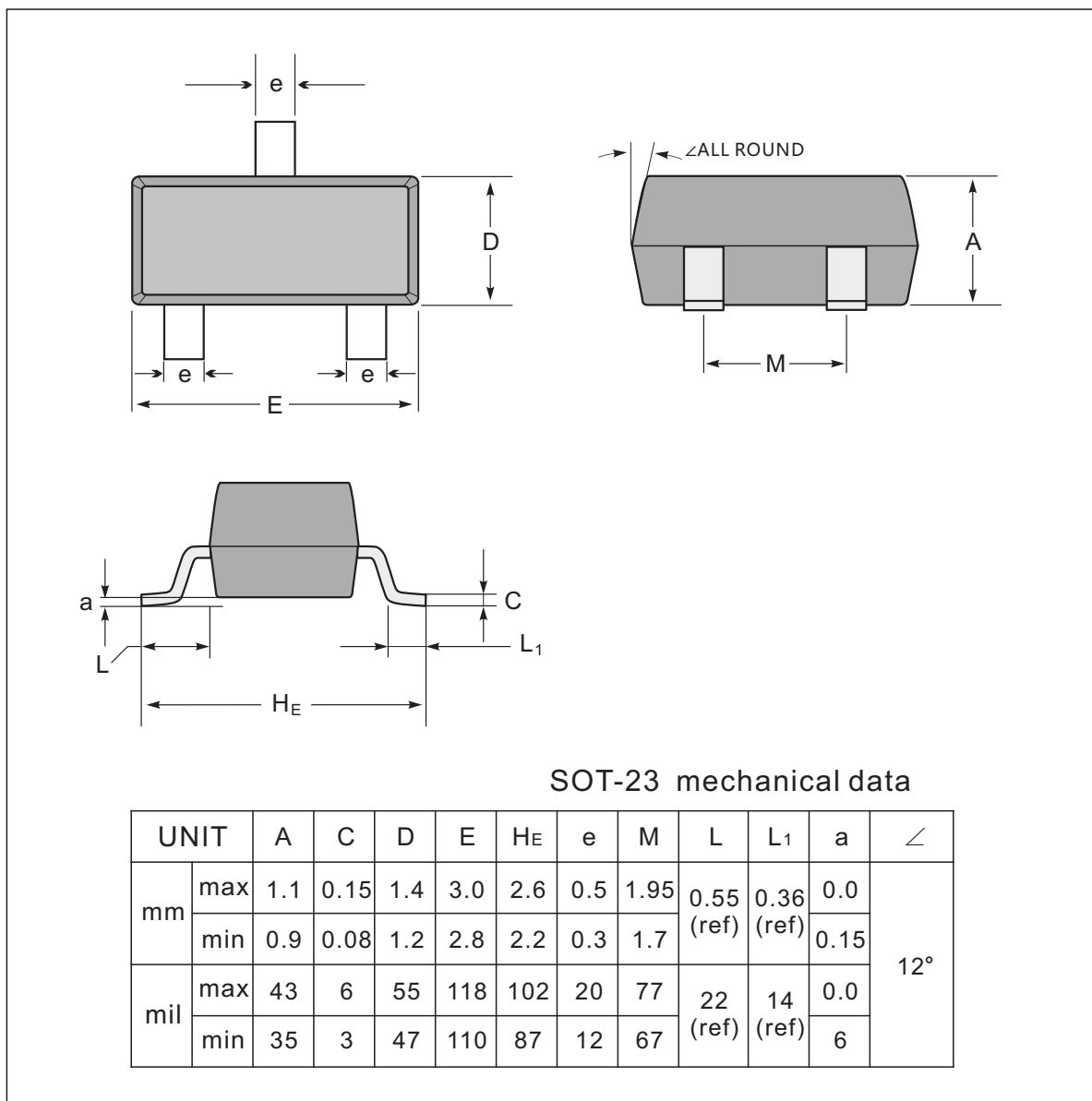

The recommended mounting pad size

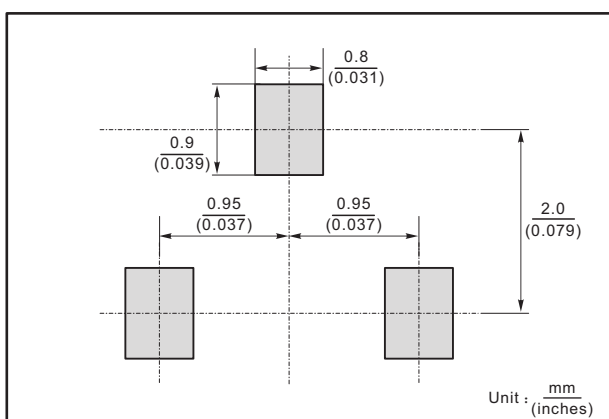

Marking

Type number	Marking code
S9015	M6



SOT-23 Packing

1. The method of packaging and dimension are shown as below figure. (Dimension in mm)

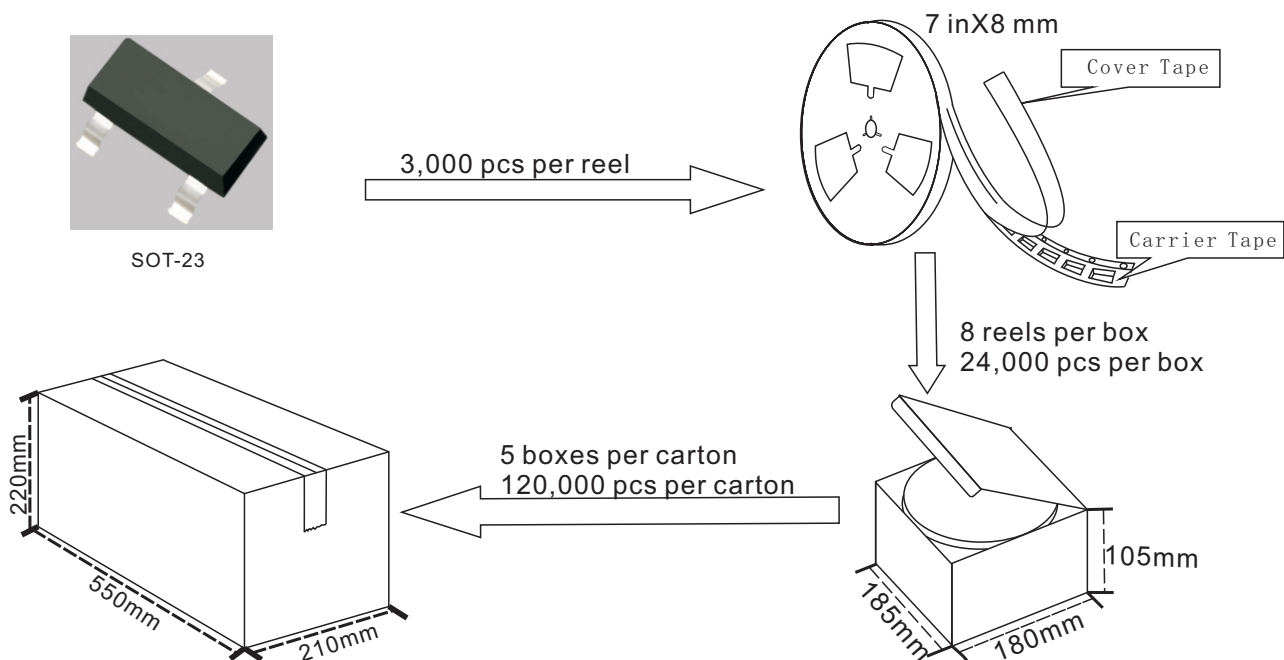

SOT-23 Embossed Carrier Tape

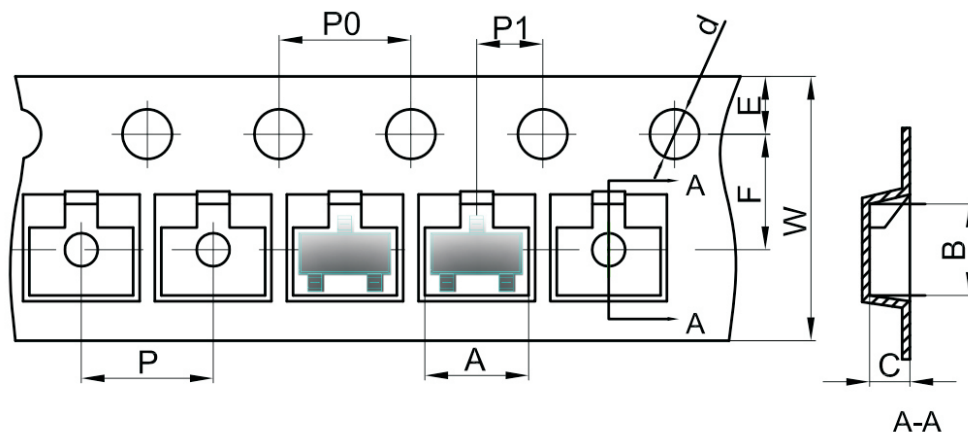

Dimensions are in millimeter

Pkg type	A	B	C	d	E	F	P0	P	P1	W
SOT-23	3.15	2.77	1.22	Ø1.50	1.75	3.50	4.00	4.00	2.00	8.00

SOT-23 Tape Leader and Trailer

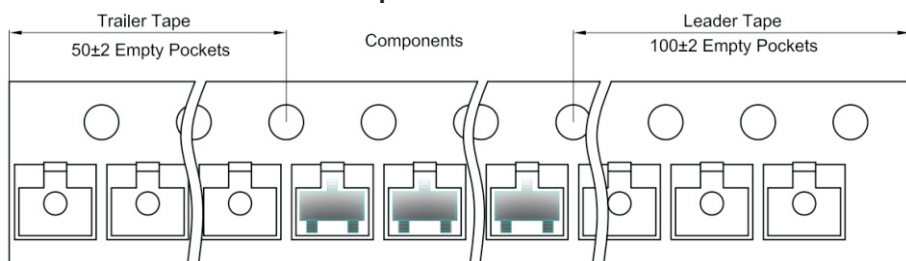

单击下面可查看定价，库存，交付和生命周期等信息

[>>JINGDAO\(晶导微\)](#)