



FEATURES

- For surface mounted applications
- Glass Passivated Chip Junction
- Fast reverse recovery time
- Ideal for automated placement
- Lead free in comply with EU RoHS 2011/65/EU directives

MECHANICAL DATA

- Case: SOD-323W
- Terminals: Solderable per MIL-STD-750, Method 2026
- Approx. Weight: 5.48mg / 0.00019oz

PINNING

PIN	DESCRIPTION
1	Cathode
2	Anode

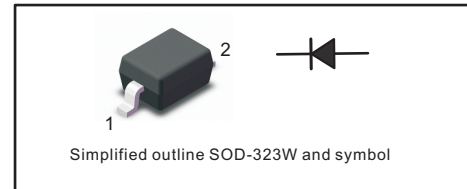

Absolute Maximum Ratings at 25 °C

Parameter	Symbols	T-1N4148WB	Units
Maximum Repetitive Peak Reverse Voltage	V_{RRM}	100	V
Maximum RMS voltage	V_{RMS}	75	V
Average Rectified Forward Current	$I_{F(AV)}$	150	mA
Non-repetitive Peak Forward Surge Current	I_{FSM}	0.5 1 4	A
at 1s at 1ms at 1us			
Total Power Dissipation	P_{tot}	400	mW
Operating and Storage Temperature Range	T_j, T_{stg}	-55 ~ +150	°C

Characteristics at $T_a = 25\text{ °C}$

Parameter	Symbols	T-1N4148WB	Units
Reverse Breakdown Voltage at $I_R = 1\mu A$	$V_{(BR)R}$	75	V
Maximum Forward Voltage	V_F	0.715 0.855 1.00 1.25	V
at 1 mA at 10 mA at 50 mA at 150 mA			
Peak Reverse Current	I_R	0.025 1 30 50	μA
at $V_R = 20V$ $T_j = 25\text{ °C}$ at $V_R = 75V$ $T_j = 25\text{ °C}$ at $V_R = 25V$ $T_j = 150\text{ °C}$ at $V_R = 75V$ $T_j = 150\text{ °C}$			
Typical Junction Capacitance $f = 1MHz, V_R = 0V$	C_j	2	pF
Maximum Reverse Recovery Time ⁽¹⁾	t_{rr}	4	ns

(1) Measured with $I_F = I_R = 10mA, I_{rr} = 0.1 \times I_R, R_L = 100\Omega$



Fig.1 Power Derating Curve

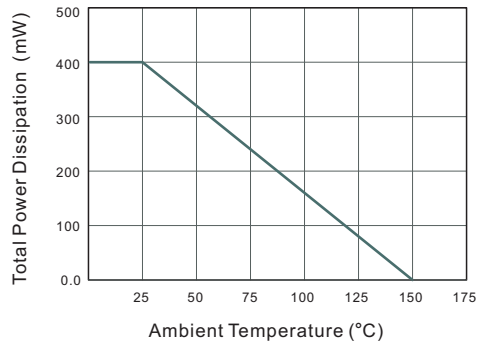

Fig.2 Typical Reverse Characteristics

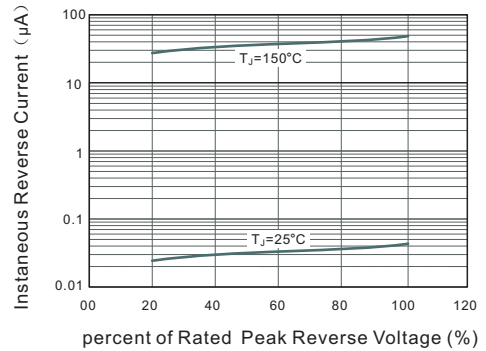

Fig.3 Typical Instaneous Forward Characteristics

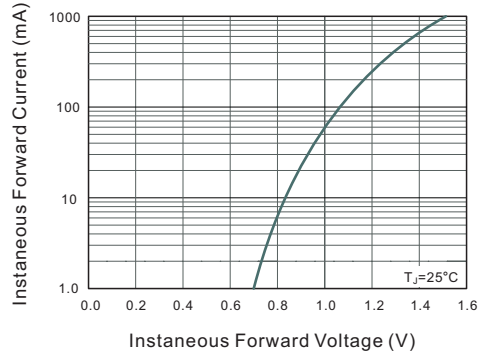
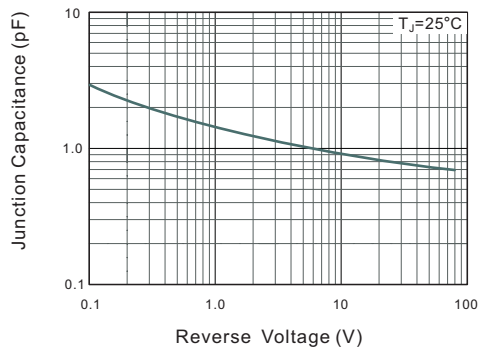

Fig.4 Typical Junction Capacitance





PACKAGE OUTLINE

Plastic surface mounted package; 2 leads

SOD-323W

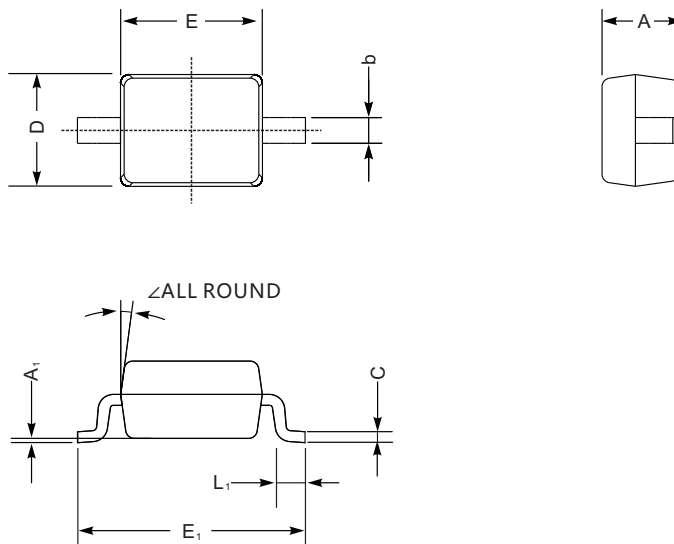

SOD-323W mechanical data

UNIT		A	C	D	E	E ₁	b	L ₁	A ₁	∠
mm	max	1.1	0.15	1.4	1.8	2.75	0.4	0.45	0.2	9°
	min	0.8	0.08	1.2	1.4	2.55	0.25	0.2	—	
mil	max	43	5.9	55	70	108	16	16	8	
	min	32	3.1	47	63	100	9.8	7.9	—	

The recommended mounting pad size

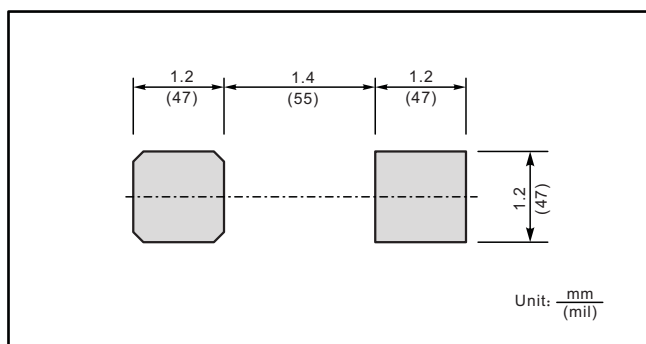

Marking

Type number	Marking code
T-1N4148WB	T4

单击下面可查看定价，库存，交付和生命周期等信息

[>>JINGDAO\(晶导微\)](#)