



Surface Mount Schottky Barrier Rectifier
Reverse Voltage - 20 to 200V
Forward Current - 2.0A

FEATURES

- Metal silicon junction, majority carrier conduction
- For surface mounted applications
- Low power loss, high efficiency
- High forward surge current capability
- For use in low voltage, high frequency inverters, free wheeling, and polarity protection applications

MECHANICAL DATA

- Case : SMB
- Terminals: Solderable per MIL-STD-750, Method 2026
- Approx. Weight : 0.055g / 0.002oz

PINNING

PIN	DESCRIPTION
1	Cathode
2	Anode

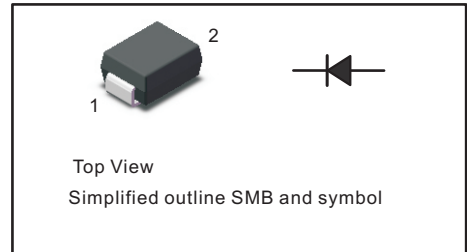

Absolute Maximum Ratings and Electrical characteristics

Ratings at 25 °C ambient temperature unless otherwise specified. Single phase, half wave, 60Hz resistive or inductive load, for capacitive load, derate by 20 %

Parameter	Symbols	SS22B	SS24B	SS26B	SS28B	SS210B	SS212B	SS215B	SS220B	Units
Maximum Repetitive Peak Reverse Voltage	V_{RRM}	20	40	60	80	100	120	150	200	V
Maximum RMS voltage	V_{RMS}	14	28	42	56	70	84	105	140	V
Maximum DC Blocking Voltage	V_{DC}	20	40	60	80	100	120	150	200	V
Maximum Average Forward Rectified Current	$I_{F(AV)}$	2.0								A
Peak Forward Surge Current, 8.3ms Single Half Sine-wave Superimposed on Rated Load (JEDEC method)	I_{FSM}	55				45				A
Max Instantaneous Forward Voltage at 2 A	V_F	0.55		0.70		0.85		0.95		V
Maximum DC Reverse Current $T_a = 25^{\circ}C$ at Rated DC Reverse Voltage $T_a = 100^{\circ}C$	I_R	0.5 5			0.3 3				mA	
Typical Junction Capacitance ⁽¹⁾	C_j	220			110				pF	
Typical Thermal Resistance ⁽²⁾	$R_{\theta JA}$	60								$^{\circ}C/W$
Operating Junction Temperature Range	T_j	-55 ~ +125								$^{\circ}C$
Storage Temperature Range	T_{stg}	-55 ~ +150								$^{\circ}C$

(1) Measured at 1 MHz and applied reverse voltage of 4 V D.C
(2) P.C.B. mounted with 2.0" X 2.0" (5 X 5 cm) copper pad areas.



Fig.1 Forward Current Derating Curve

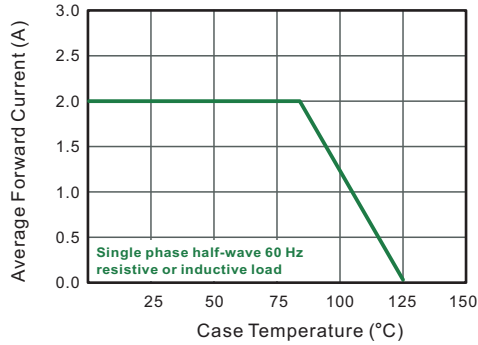

Fig.2 Typical Reverse Characteristics

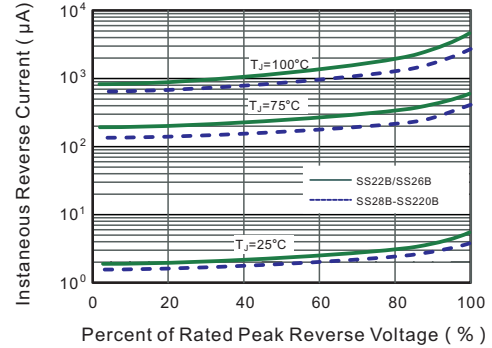

Fig.3 Typical Forward Characteristic

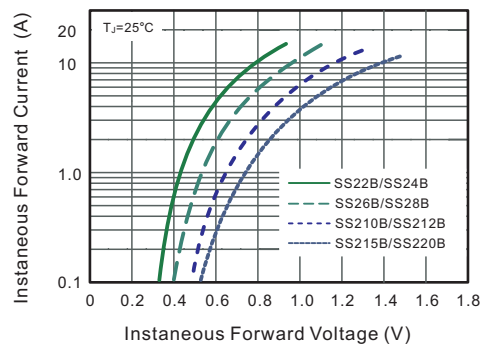

Fig.4 Typical Junction Capacitance

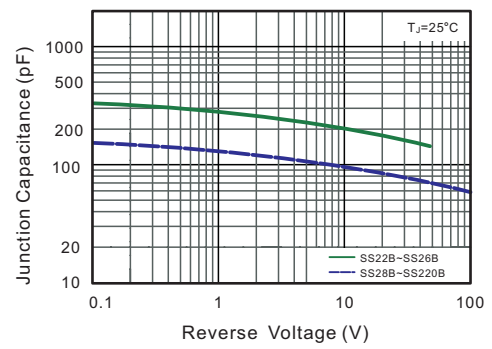

Fig.5 Maximum Non-Repetitive Peak Forward Surge Current

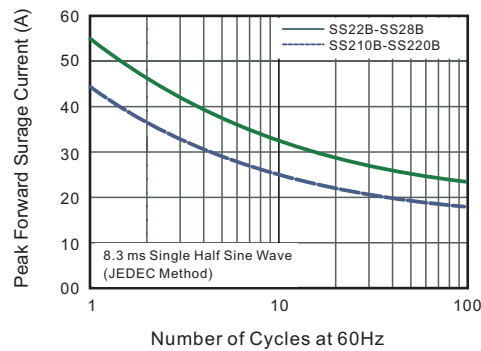
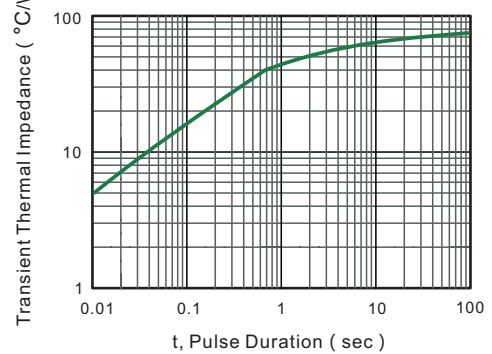

Fig.6- Typical Transient Thermal Impedance





PACKAGE OUTLINE

Plastic surface mounted package; 2 leads

SMB

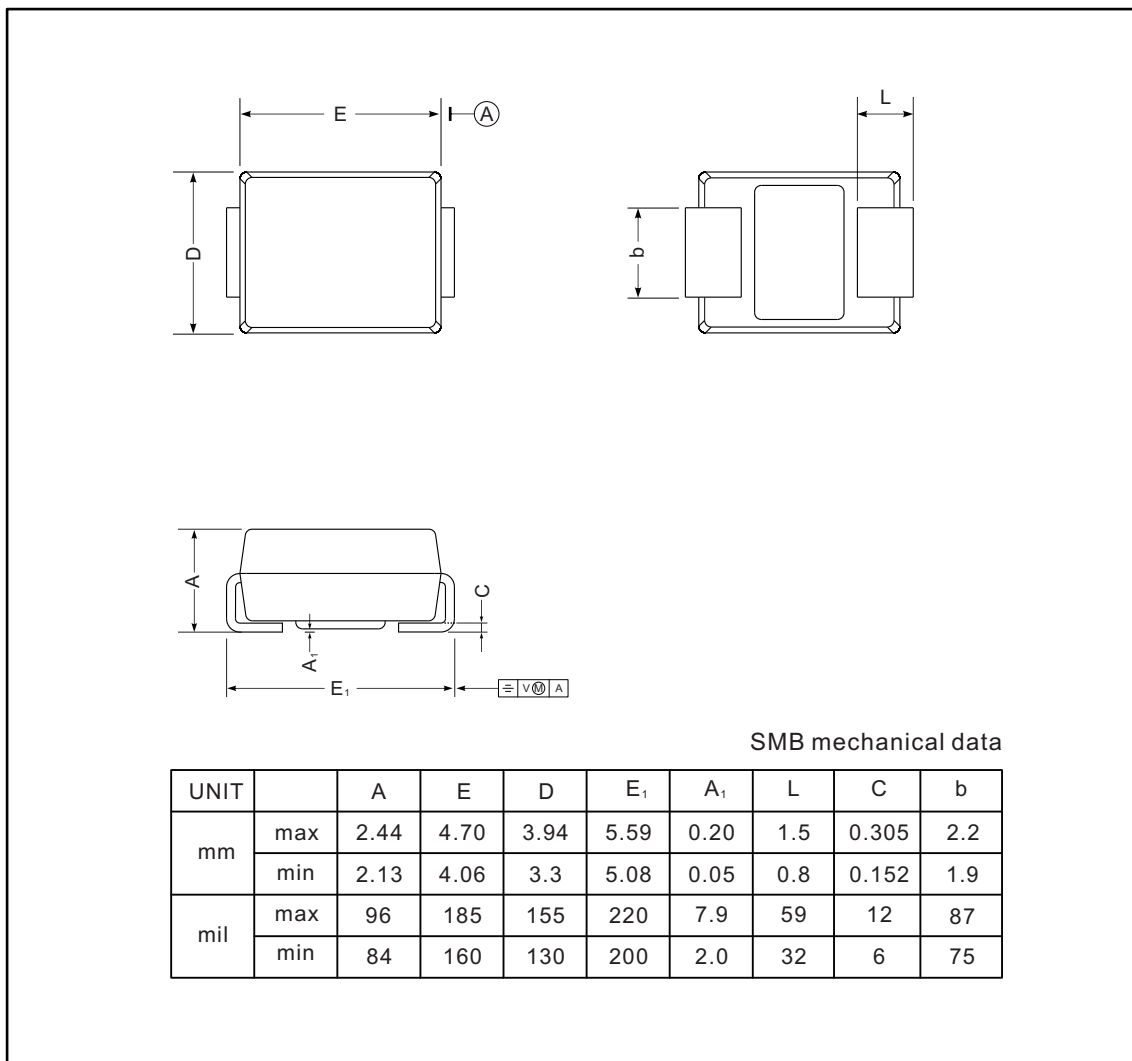

The recommended mounting pad size

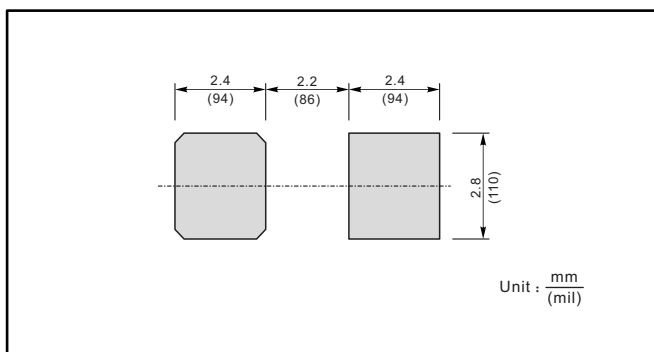

Marking

Type number	Marking code
SS22B	SS22
SS24B	SS24
SS26B	SS26
SS28B	SS28
SS210B	SS210
SS212B	SS212
SS215B	SS215
SS220B	SS220

单击下面可查看定价，库存，交付和生命周期等信息

[>>JINGDAO\(晶导微\)](#)