



650V SuperJunction Power MOSFET

Features

- Extremely Low Gate Charge
- Excellent Output Capacitance (C_{oss}) Profile
- Fast Switching Capability
- Ultra Fast Body Diode
- 100% UIS Tested, 100% R_g Tested
- Pb-free Lead Plating
- Halogen-free and RoHS-compliant

Product Summary

Parameter	Value	Unit
V_{DS}	650	V
$V_{GS(th)}_{Typ}$	4.0	V
I_D (@ $V_{GS} = 10V$) ⁽¹⁾	71	A
$R_{DS(ON)}_{Typ}$ (@ $V_{GS} = 10V$)	35	m Ω
$E_{oss@400V}$	16.0	μJ

Applications

- Telecom / Server Power Supplies
- Industrial Power Supplies
- UPS / Solar
- Lighting / Charger / Adapter

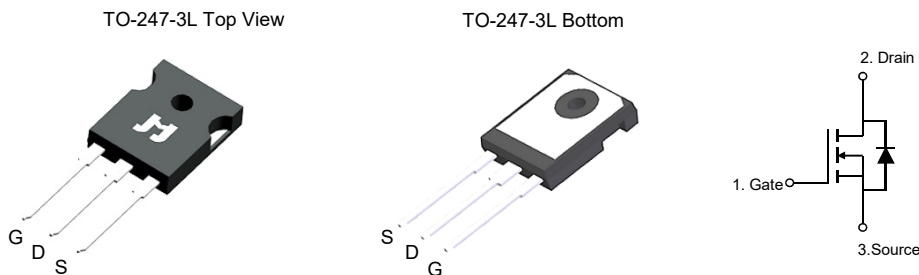

Ordering Information

Device	Package	# of Pins	Marking	MSL	T_J (°C)	Media	Quantity (pcs)
JMH65R040ASFD-U	TO-247-3L	3	H65R040AF	NA	-55 to 150	Tube	30

Absolute Maximum Ratings (@ $T_A = 25^\circ C$ unless otherwise specified)

Parameter	Symbol	Value	Unit
Drain-to-Source Voltage	V_{DS}	650	V
Gate-to-Source Voltage	V_{GS}	± 20	V
Continuous Drain Current ⁽¹⁾	I_D	$T_C = 25^\circ C$	71
		$T_C = 100^\circ C$	45
Pulsed Drain Current ⁽²⁾	I_{DM}	260	A
Avalanche Current ⁽³⁾	I_{AS}	15.0	A
Avalanche Energy ⁽³⁾	E_{AS}	1125	mJ
Power Dissipation ⁽⁴⁾	P_D	$T_C = 25^\circ C$	500
		$T_C = 100^\circ C$	200
Junction & Storage Temperature Range	T_J, T_{STG}	-55 to 150	$^\circ C$

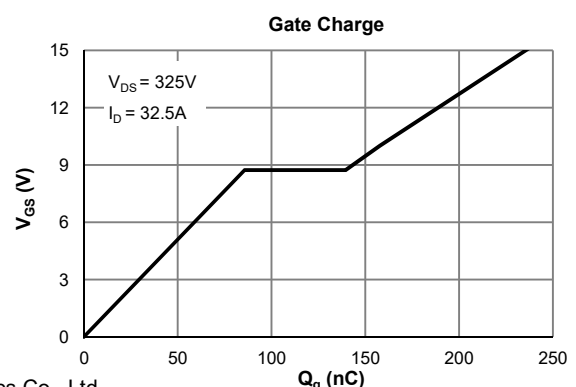
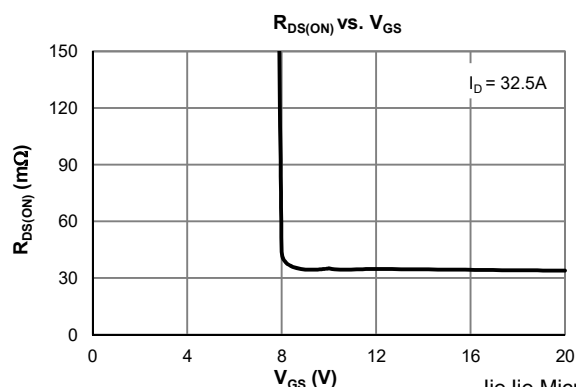

**Electrical Characteristics** (@ $T_J = 25^\circ\text{C}$ unless otherwise specified)

Parameter	Symbol	Conditions	Min.	Typ.	Max.	Unit
STATIC PARAMETERS						
Drain-Source Breakdown Voltage	$V_{(BR)DSS}$	$I_D = 250\mu\text{A}, V_{GS} = 0\text{V}$	650			V
Zero Gate Voltage Drain Current	I_{DSS}	$V_{DS} = 650\text{V}, V_{GS} = 0\text{V}$			5.0	μA
Gate-Body Leakage Current	I_{GSS}	$V_{DS} = 0\text{V}, V_{GS} = \pm 20\text{V}$			± 100	nA
Gate Threshold Voltage	$V_{GS(th)}$	$V_{DS} = V_{GS}, I_D = 250\mu\text{A}$	3.0	4.0	5.0	V
Static Drain-Source ON-Resistance	$R_{DS(on)}$	$V_{GS} = 10\text{V}, I_D = 32.5\text{A}$		35	40	m Ω
Diode Forward Voltage	V_{SD}	$I_S = 1\text{A}, V_{GS} = 0\text{V}$		0.75	1.0	V
Diode Continuous Current	I_S	$T_C = 25^\circ\text{C}$			71	A
DYNAMIC PARAMETERS ⁽⁵⁾						
Input Capacitance	C_{iss}	$V_{GS} = 0\text{V}, V_{DS} = 100\text{V}, f = 1\text{MHz}$		6843		pF
Output Capacitance	C_{oss}			172		pF
Reverse Transfer Capacitance	C_{rss}			401		pF
Effective output capacitance, energy related	$C_{o(er)}$	$V_{GS} = 0\text{V}, V_{DS} = 0 \text{ to } 400\text{V}$		200		pF
Effective output capacitance, time related	$C_{o(tr)}$			2036		pF
Gate Resistance	R_g	$V_{GS} = 0\text{V}, V_{DS} = 0\text{V}, f = 1\text{MHz}$		0.66		Ω
SWITCHING PARAMETERS ⁽⁵⁾						
Total Gate Charge (@ $V_{GS} = 10\text{V}$)	Q_g	$V_{GS} = 0 \text{ to } 10\text{V}$ $V_{DS} = 325\text{V}, I_D = 10\text{A}$		163		nC
Gate Source Charge	Q_{gs}			81		nC
Gate Drain Charge	Q_{gd}			54		nC
Turn-On DelayTime	$t_{D(on)}$	$V_{GS} = 10\text{V}, V_{DS} = 325\text{V}$ $R_L = 3.25\Omega, R_{GEN} = 6\Omega$		52.0		ns
Turn-On Rise Time	t_r			84		ns
Turn-Off DelayTime	$t_{D(off)}$			63		ns
Turn-Off Fall Time	t_f			10.6		ns
Body Diode Reverse Recovery Time	t_{rr}	$I_F = 32.5\text{A}, di/dt = 100\text{A}/\mu\text{s}$		195		ns
Body Diode Reverse Recovery Charge	Q_{rr}	$I_F = 32.5\text{A}, di/dt = 100\text{A}/\mu\text{s}$		1.7		μC
Peak Diode Recovery Voltage Slope	dv/dt	$I_F \leq 32.5\text{A}, di/dt = 200\text{A}/\mu\text{s}, V_{DS} = 400\text{V}$		50		V/ns
MOSFET dv/dt Ruggedness	dv/dt	$V_{DS} = 0 \dots 400\text{V}$		50		V/ns

Thermal Performance

Parameter	Symbol	Typ.	Max.	Unit
Thermal Resistance, Junction-to-Ambient	$R_{\theta JA}$	40	50	$^\circ\text{C}/\text{W}$
Thermal Resistance, Junction-to-Case	$R_{\theta JC}$	0.25	0.30	$^\circ\text{C}/\text{W}$

Notes:

1. Computed continuous current assumes the condition of T_{J_Max} while the actual continuous current depends on the thermal & electro-mechanical application board design.
2. This single-pulse measurement was taken under $T_{J_Max} = 150^\circ\text{C}$.
3. This single-pulse measurement was taken under the following condition [$L = 10\text{mH}, V_{GS} = 10\text{V}, V_{DD} = 50\text{V}$] while its value is limited by $T_{J_Max} = 150^\circ\text{C}$.
4. The power dissipation P_D is based on $T_{J_Max} = 150^\circ\text{C}$.
5. This value is guaranteed by design hence it is not included in the production test.

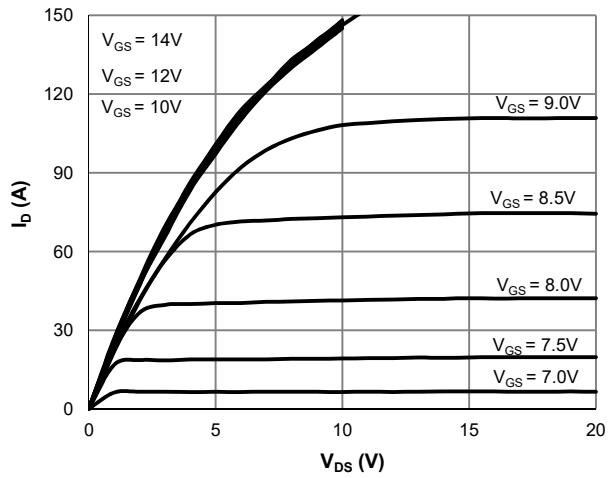
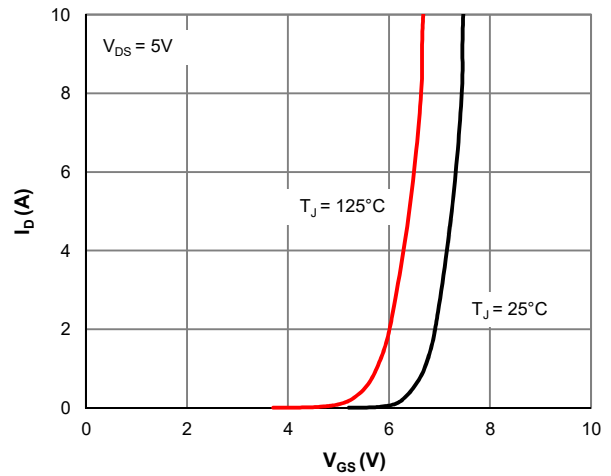
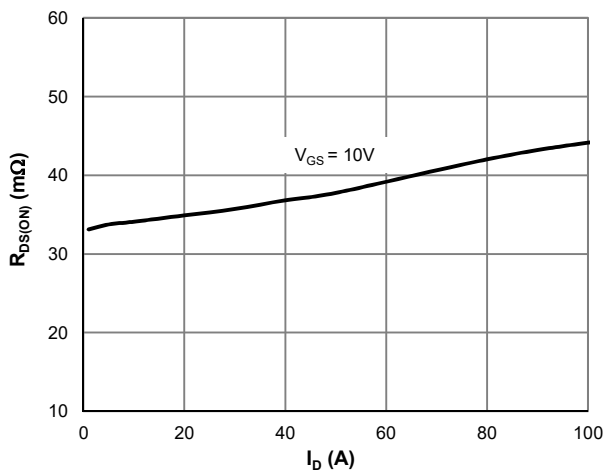
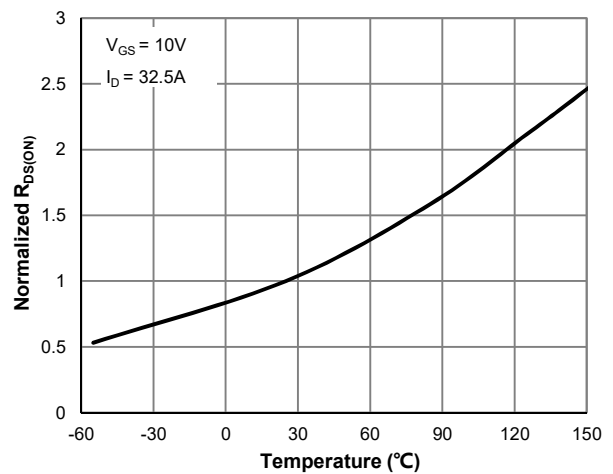
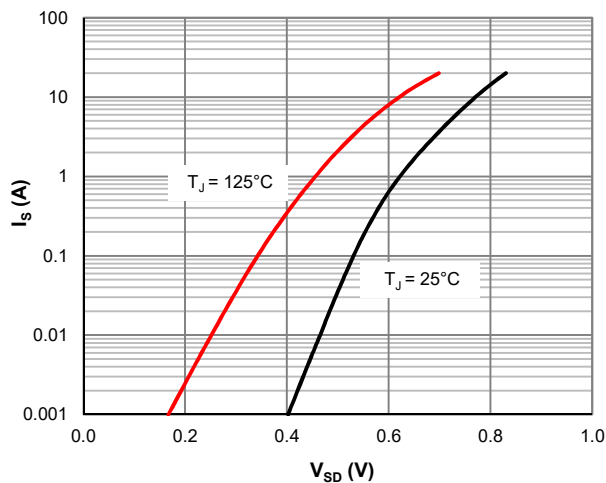
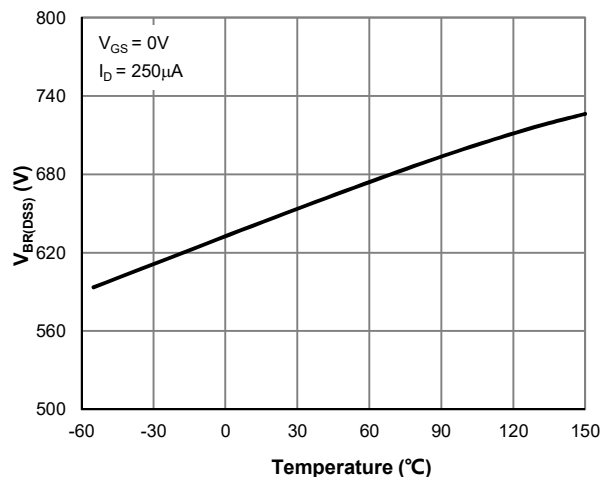
Typical Electrical & Thermal Characteristics

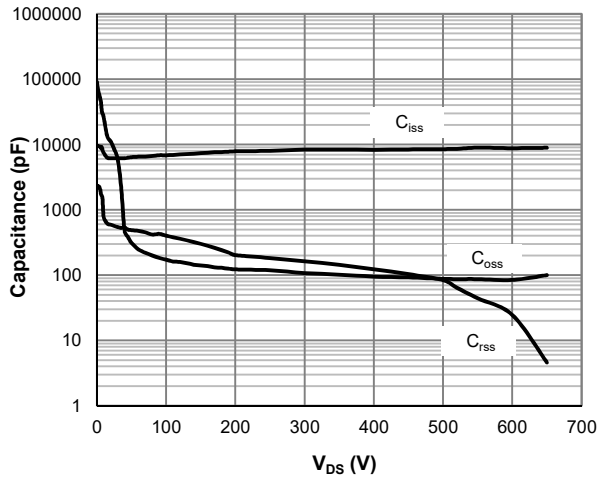
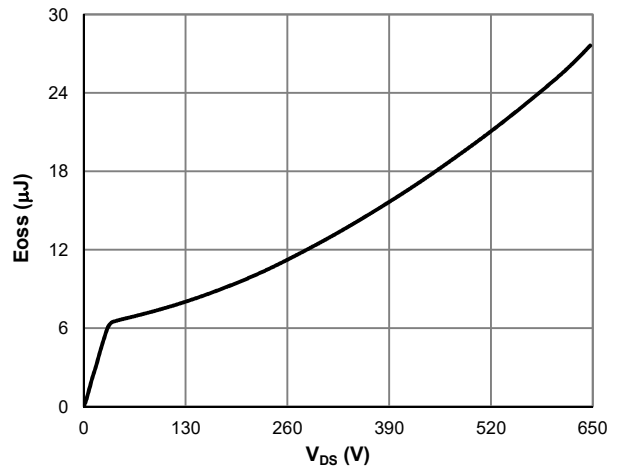
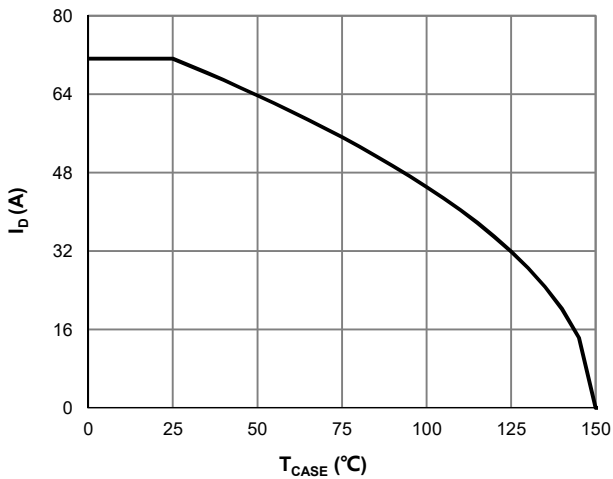
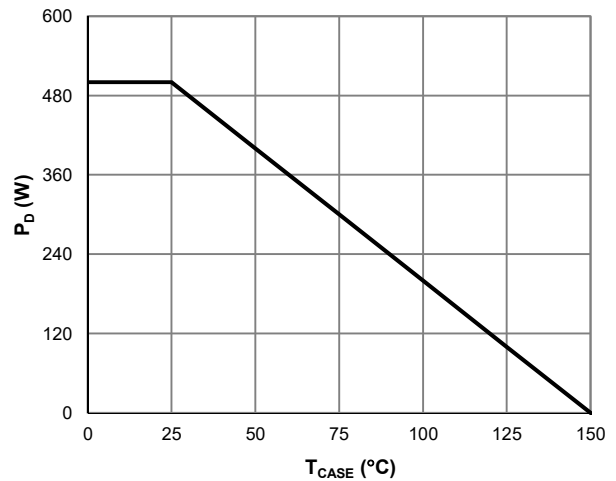
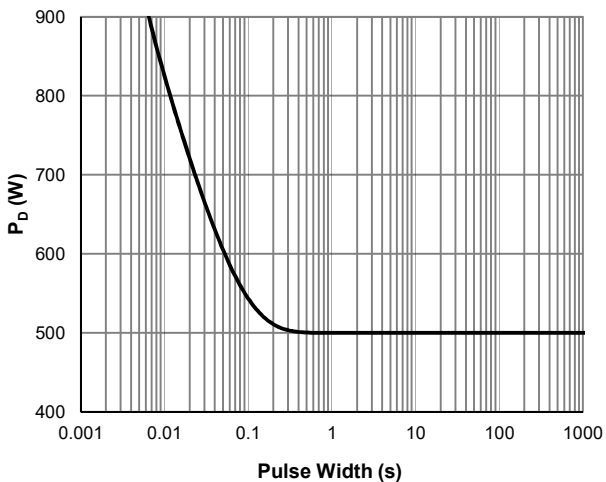
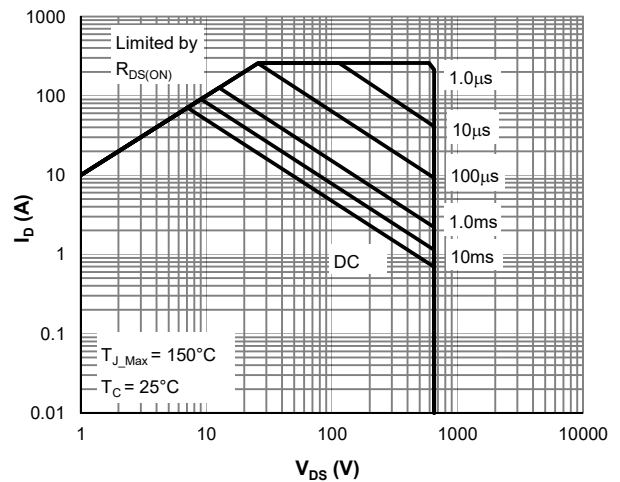
Figure 1: Saturation Characteristics

Figure 2: Transfer Characteristics

Figure 3: $R_{DS(ON)}$ vs. Drain Current

Figure 4: $R_{DS(ON)}$ vs. Junction Temperature

Figure 5: Body-Diode Characteristics

Figure 6: $V_{BR(DSS)}$ vs. Junction Temperature

Typical Electrical & Thermal Characteristics

Figure 7: Capacitance Characteristics

Figure 8: Coss Stored Energy

Figure 9: Current De-rating

Figure 10: Power De-rating

Figure 11: Single Pulse Power Rating, Junction-to-Case

Figure 12: Maximum Safe Operating Area



Typical Electrical & Thermal Characteristics

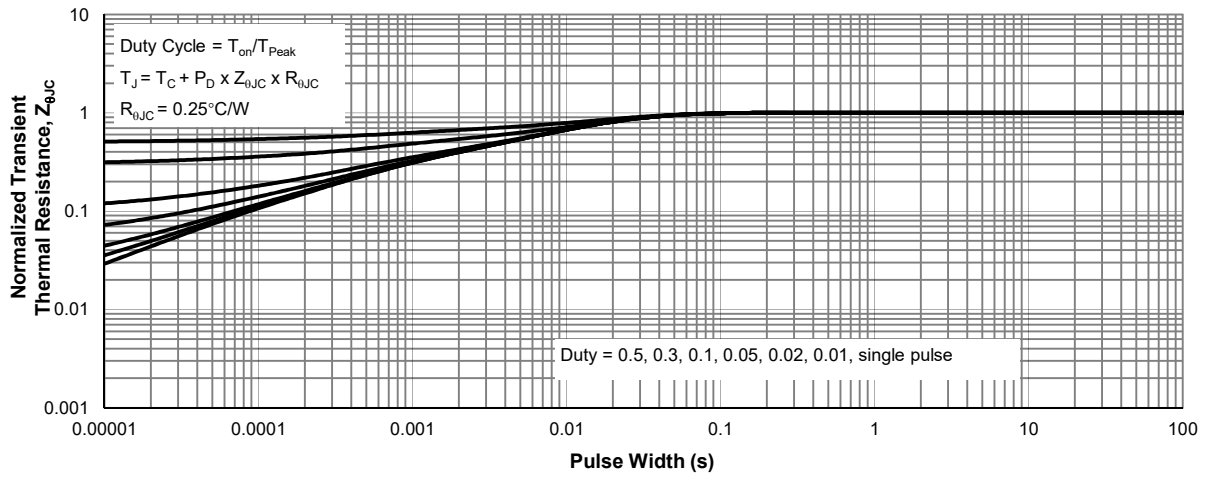
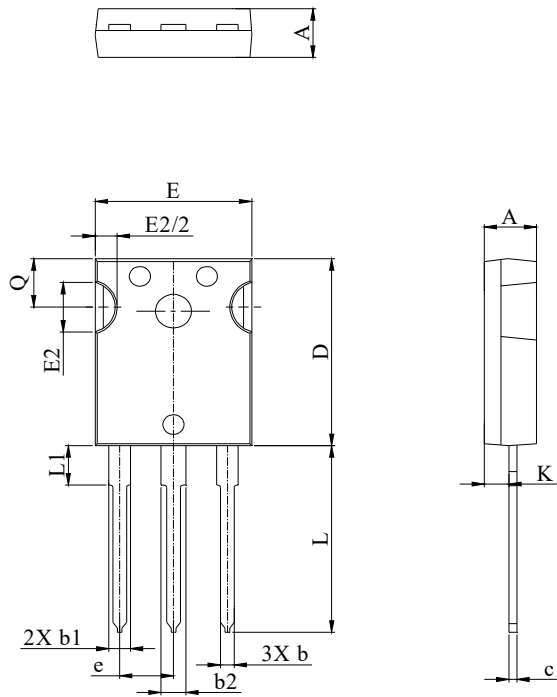

Figure 13: Normalized Maximum Transient Thermal Impedance

TO-247-3L Package Information
Package Outline

DIM.	MILLIMETER		
	MIN.	NOM.	MAX.
A	4.80	5.02	5.21
b	1.00	1.20	1.40
b1	1.90	2.00	2.39
b2	2.87	3.00	3.22
c	0.41	0.60	0.79
D	20.80	21.00	21.20
E	15.50	15.94	16.13
E2	4.32		5.49
L	19.70	20.07	20.32
L1	4.00		4.40
K	2.20		2.50
e	5.44 BSC		

单击下面可查看定价，库存，交付和生命周期等信息

[>>JW\(捷捷微\)](#)