



150V 4.0mΩ N-Ch Power MOSFET

Features

- Ultra-low $R_{DS(ON)}$
- Low Gate Charge
- 100% UIS Tested, 100% R_g Tested
- Pb-free Lead Plating
- Halogen-free and RoHS-compliant

Product Summary

Parameter	Value	Unit
V_{DS}	150	V
$V_{GS(th_Typ)}$	3.2	V
I_D (@ $V_{GS} = 10V$) ⁽¹⁾	212	A
$R_{DS(ON_Typ)}$ (@ $V_{GS} = 10V$)	4.0	mΩ

Applications

- Power Management in Telecom., Industrial Automation, CE
- Current Switching in DC/DC & AC/DC (SR) Sub-systems
- Motor Driving in Power Tool, E-vehicle, Robotics

TO-247-3L Top View

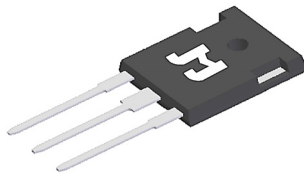

TO-247-3L Bottom View

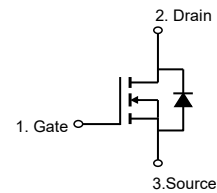
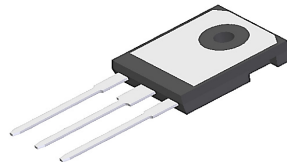

Ordering Information

Device	Package	# of Pins	Marking	MSL	T_J (°C)	Media	Quantity (pcs)
JMSH1504NS-U	TO-247-3L	3	SH1504N	NA	-55 to 150	Tube	30

Absolute Maximum Ratings (@ $T_A = 25^\circ C$ unless otherwise specified)

Parameter	Symbol	Value	Unit
Drain-to-Source Voltage	V_{DS}	150	V
Gate-to-Source Voltage	V_{GS}	±20	V
Continuous Drain Current ⁽¹⁾	I_D	$T_C = 25^\circ C$	212
		$T_C = 100^\circ C$	134
Pulsed Drain Current ⁽²⁾	I_{DM}	848	A
Avalanche Energy ⁽³⁾	E_{AS}	1350	mJ
Power Dissipation ⁽⁴⁾	P_D	$T_C = 25^\circ C$	500
		$T_C = 100^\circ C$	200
Junction & Storage Temperature Range	T_J, T_{STG}	-55 to 150	°C

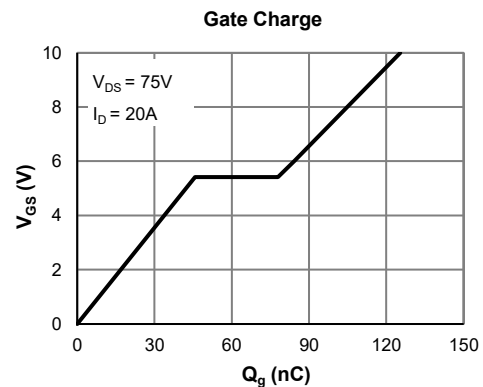
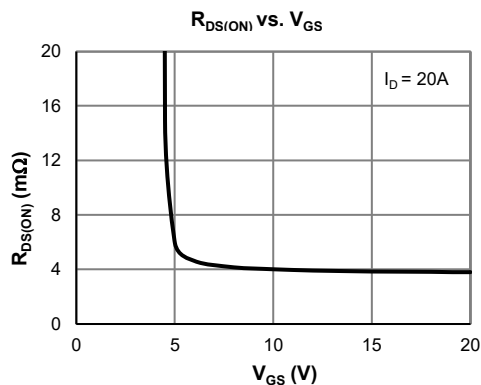



Electrical Characteristics (@ $T_J = 25^\circ\text{C}$ unless otherwise specified)

Parameter	Symbol	Conditions	Min.	Typ.	Max.	Unit
STATIC PARAMETERS						
Drain-Source Breakdown Voltage	$V_{(BR)DSS}$	$I_D = 250\mu\text{A}, V_{GS} = 0\text{V}$	150			V
Zero Gate Voltage Drain Current	I_{DSS}	$V_{DS} = 120\text{V}, V_{GS} = 0\text{V}$ $T_J = 55^\circ\text{C}$			1.0 5.0	μA
Gate-Body Leakage Current	I_{GSS}	$V_{DS} = 0\text{V}, V_{GS} = \pm 20\text{V}$			± 100	nA
Gate Threshold Voltage	$V_{GS(th)}$	$V_{DS} = V_{GS}, I_D = 250\mu\text{A}$	2.5	3.2	4.5	V
Static Drain-Source ON-Resistance	$R_{DS(ON)}$	$V_{GS} = 10\text{V}, I_D = 20\text{A}$		4.0	4.8	m Ω
Forward Transconductance	g_{FS}	$V_{DS} = 5\text{V}, I_D = 20\text{A}$		61		S
Diode Forward Voltage	V_{SD}	$I_S = 1\text{A}, V_{GS} = 0\text{V}$		0.70	1.0	V
Diode Continuous Current	I_S	$T_C = 25^\circ\text{C}$			212	A

DYNAMIC PARAMETERS ⁽⁵⁾

Input Capacitance	C_{iss}	$V_{GS} = 0\text{V}, V_{DS} = 75\text{V}, f = 1\text{MHz}$		8622		pF
Output Capacitance	C_{oss}			772		pF
Reverse Transfer Capacitance	C_{rss}			26		pF
Gate Resistance	R_g	$V_{GS} = 0\text{V}, V_{DS} = 0\text{V}, f = 1\text{MHz}$		4.1		Ω

SWITCHING PARAMETERS ⁽⁵⁾

Total Gate Charge (@ $V_{GS} = 10\text{V}$)	Q_g	$V_{GS} = 0 \text{ to } 10\text{V}$ $V_{DS} = 75\text{V}, I_D = 20\text{A}$		125		nC
Total Gate Charge (@ $V_{GS} = 6\text{V}$)	Q_g			81		nC
Gate Source Charge	Q_{gs}			46		nC
Gate Drain Charge	Q_{gd}			32		nC
Turn-On Delay Time	$t_{D(on)}$	$V_{GS} = 10\text{V}, V_{DS} = 75\text{V}$ $R_L = 3.75\Omega, R_{GEN} = 3\Omega$		32		ns
Turn-On Rise Time	t_r			60		ns
Turn-Off Delay Time	$t_{D(off)}$			87		ns
Turn-Off Fall Time	t_f			48		ns
Body Diode Reverse Recovery Time	t_{rr}		$I_F = 15\text{A}, dI_F/dt = 100\text{A}/\mu\text{s}$		111	
Body Diode Reverse Recovery Charge	Q_{rr}	$I_F = 15\text{A}, dI_F/dt = 100\text{A}/\mu\text{s}$		428		nC

Thermal Performance

Parameter	Symbol	Typ.	Max.	Unit
Thermal Resistance, Junction-to-Ambient	$R_{\theta JA}$	43	50	$^\circ\text{C}/\text{W}$
Thermal Resistance, Junction-to-Case	$R_{\theta JC}$	0.25	0.30	$^\circ\text{C}/\text{W}$

Notes:

1. Computed continuous current assumes the condition of T_{J_Max} while the actual continuous current depends on the thermal & electro-mechanical application board design.
2. This single-pulse measurement was taken under $T_{J_Max} = 150^\circ\text{C}$.
3. E_{AS} of 1350 mJ is based on starting $T_J = 25^\circ\text{C}$, $L = 3.0\text{mH}$, $I_{AS} = 30\text{A}$, $V_{GS} = 10\text{V}$, $V_{DD} = 75\text{V}$; 100% test at $L = 0.3\text{mH}$, $I_{AS} = 70\text{A}$.
4. The power dissipation P_D is based on $T_{J_Max} = 150^\circ\text{C}$.
5. This value is guaranteed by design hence it is not included in the production test.

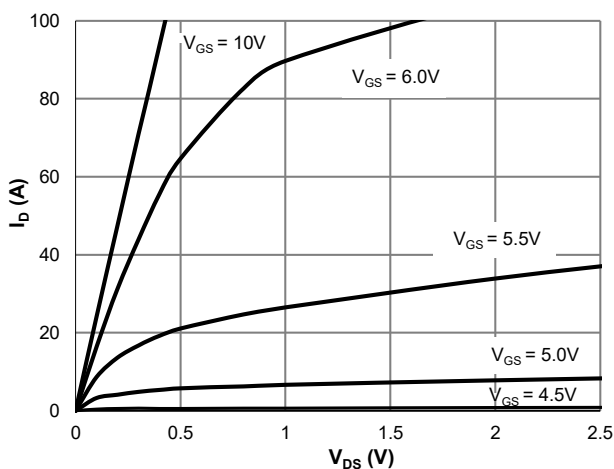
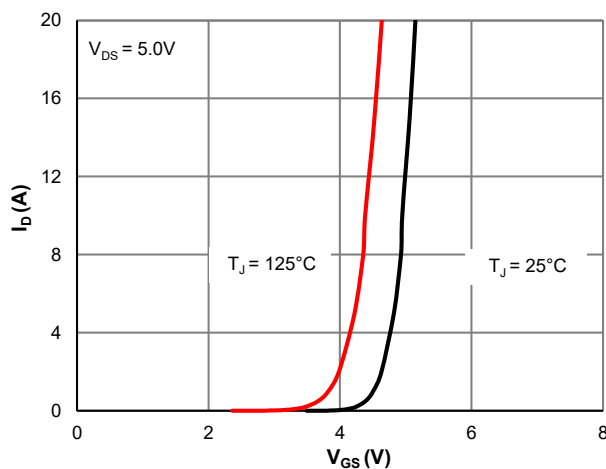
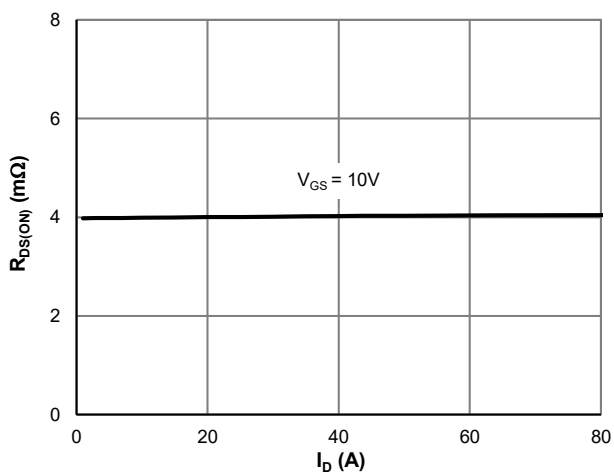
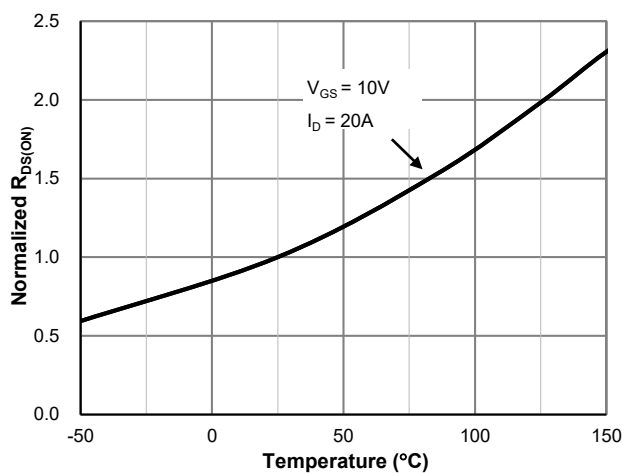
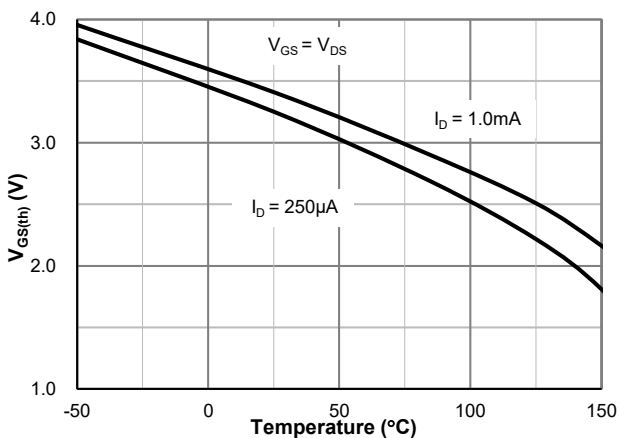
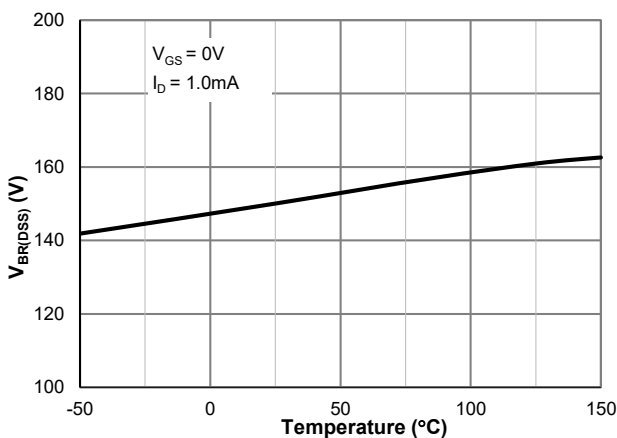
Typical Electrical & Thermal Characteristics

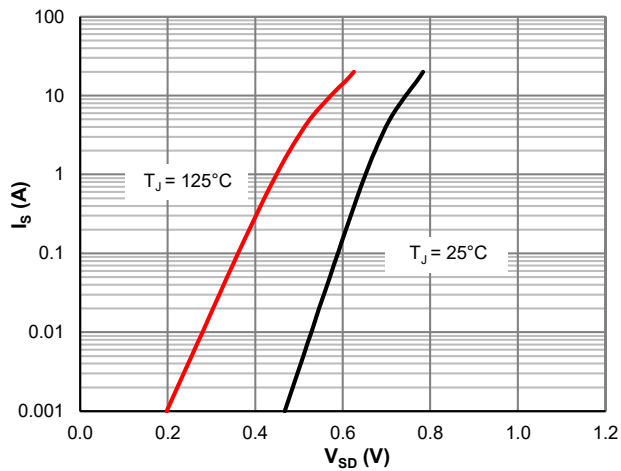
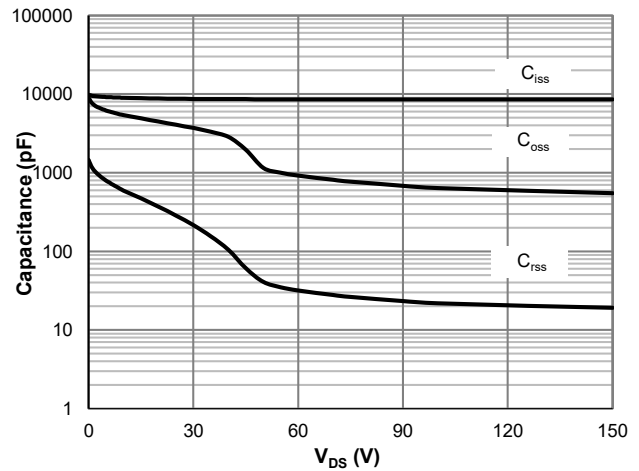
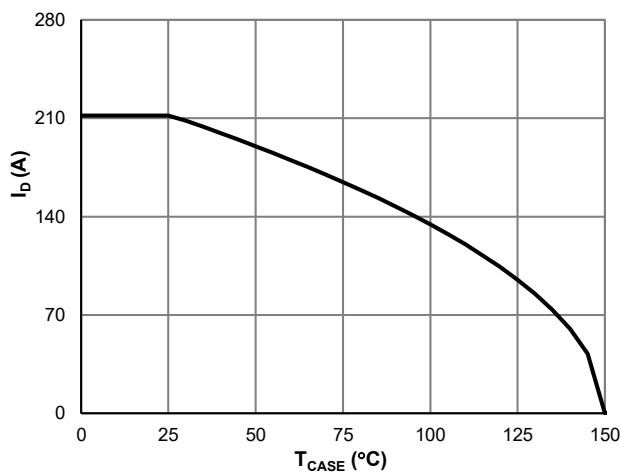
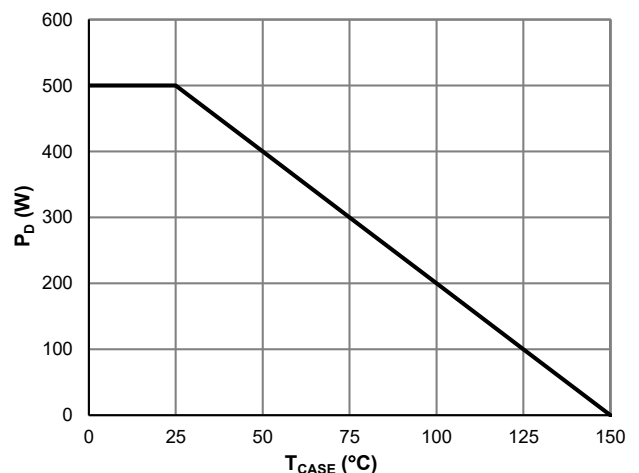
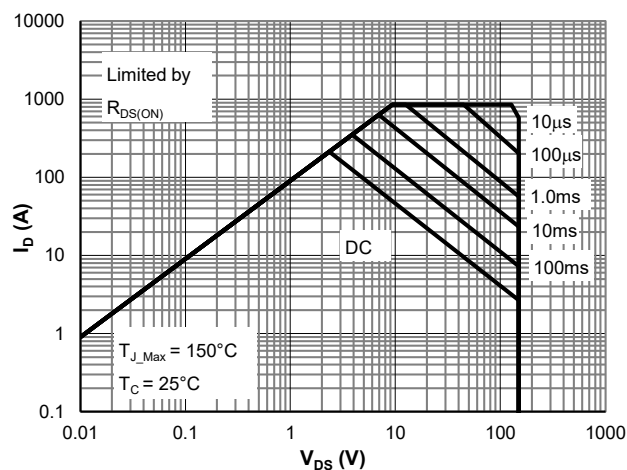
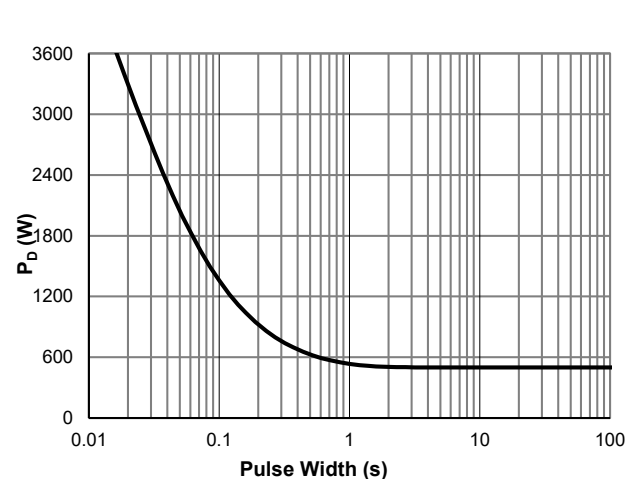
Figure 1: Saturation Characteristics

Figure 2: Transfer Characteristics

Figure 3: $R_{DS(ON)}$ vs. Drain Current

Figure 4: $R_{DS(ON)}$ vs. Junction Temperature

Figure 5: $V_{GS(th)}$ vs. Junction Temperature

Figure 6: $V_{BR(DSS)}$ vs. Junction Temperature

Typical Electrical & Thermal Characteristics

Figure 7: Body-Diode Characteristics

Figure 8: Capacitance Characteristics

Figure 9: Current De-rating

Figure 10: Power De-rating

Figure 11: Maximum Safe Operating Area

Figure 12: Single Pulse Power Rating, Junction-to-Case



Typical Electrical & Thermal Characteristics

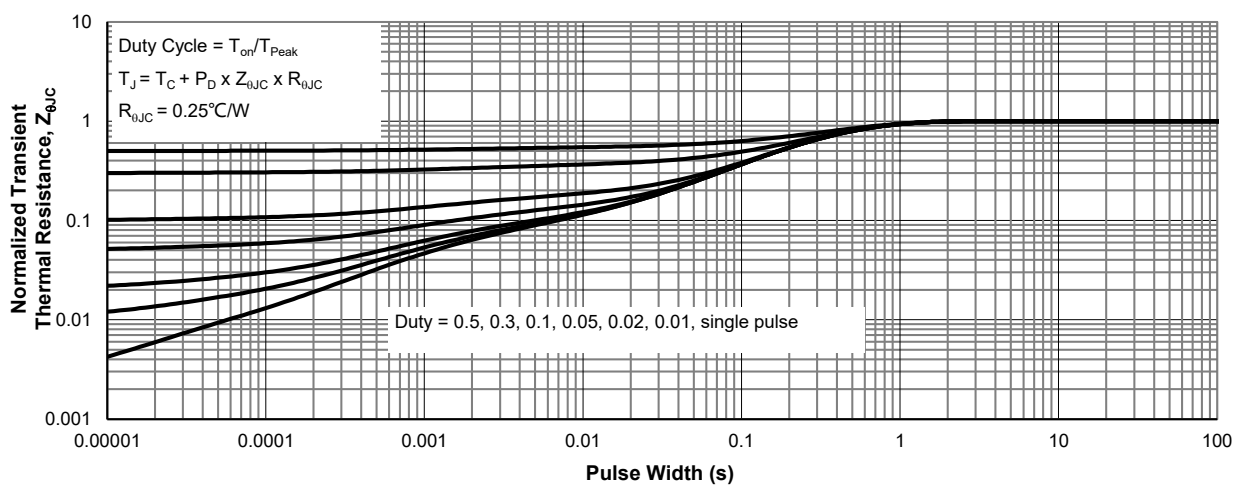
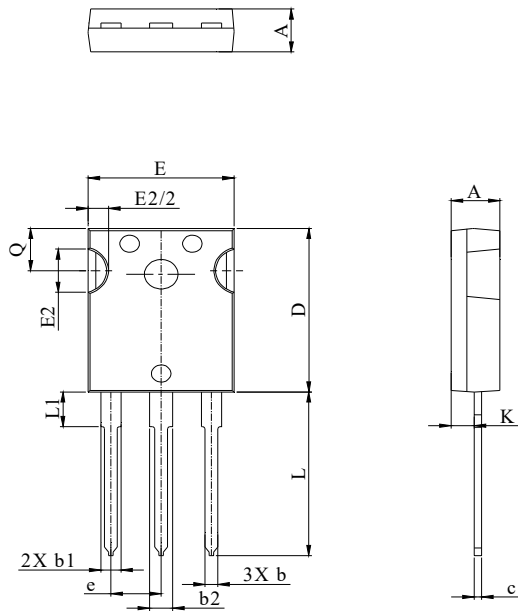
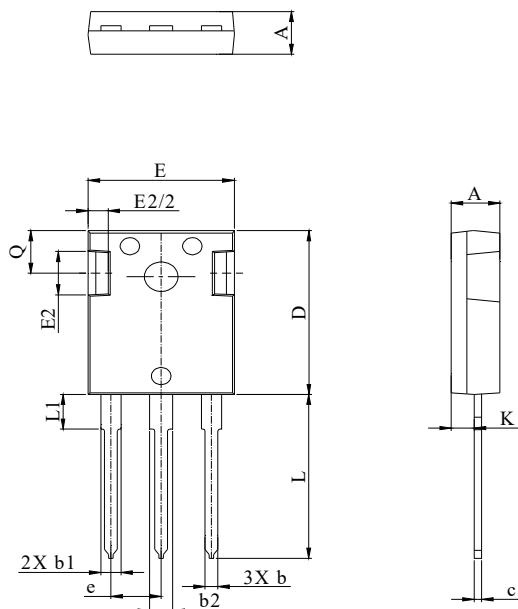

Figure 13: Normalized Maximum Transient Thermal Impedance

TO-247-3L Package Information
Type_A Package Outline

DIM.	MILLIMETER		
	MIN.	NOM.	MAX.
A	4.80	5.02	5.21
b	1.00	1.20	1.40
b1	1.90	2.00	2.39
b2	2.87	3.00	3.22
c	0.41	0.60	0.79
D	20.80	21.00	21.20
E	15.50	15.94	16.13
E2	4.32	-	5.49
L	19.70	20.07	20.32
L1	4.00	-	4.40
K	2.20	-	2.50
Q	-	5.80	-
e	5.44 BSC		

Type_B Package Outline

DIM.	MILLIMETER		
	MIN.	NOM.	MAX.
A	4.80	5.02	5.21
b	1.00	1.20	1.40
b1	1.90	2.00	2.39
b2	2.87	3.00	3.22
c	0.41	0.60	0.79
D	20.80	21.00	21.20
E	15.50	15.94	16.13
E2	4.32	-	5.49
L	19.70	20.07	20.32
L1	4.00	-	4.40
K	2.20	-	2.50
Q	-	5.80	-
e	5.44 BSC		

单击下面可查看定价，库存，交付和生命周期等信息

[>>JW\(捷捷微\)](#)