

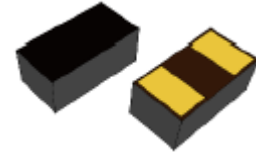

### FEATURES

- ✧ Ultra-low capacitance (0.05pF typical).
- ✧ Low leakage current(<10nA).
- ✧ Fast response time (<1ns).
- ✧ Bi-directional, single line protection.

### Polymeric ESD suppressor



0603

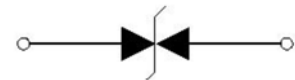

### MAIN APPLICATIONS

- ✧ Smart phone/Mobile internet device.
- ✧ Laptop/Desktop computer.
- ✧ Antennas(Cell phnoe, GPS...)
- ✧ USB 3.0,USB 3.1 and high speed interface.

### ELECTRICAL PARAMETERS (T=25°C)

Parameter	Symbol	Conditions	Min	Typ	Max	Unit
Working voltage	$V_{DC}$				24	V
Trigger voltage	$V_T$	IEC61000-4-2 8kV Contact discharge		450		V
clamping voltage	$V_C$	IEC61000-4-2 8kV Contact discharge		40		V
Leakage current	$I_L$	$V_{DC}=24V$			10	nA
Junction capacitance	$C_J$	f =10MHz		0.05		pF
ESD pulse withstand	Pulses	IEC61000-4-2 8kV Contact discharge	1000			

**GENERAL CHARACTERISTICS**

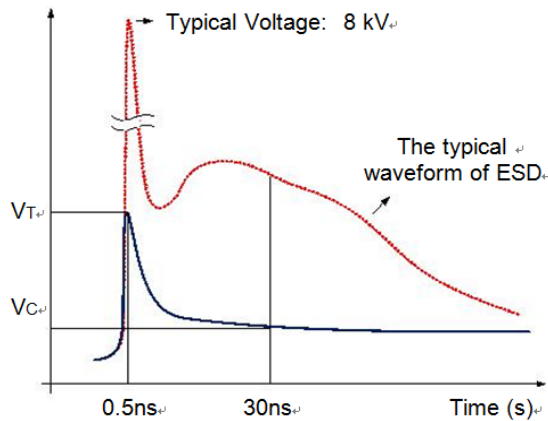

IEC61000-4-2 Standards

Level	First Peak Current (A)	Peak Current at 30 ns (A)	Peak Current at 60 ns (A)	Test Voltage (Contact Discharge) (kV)	Test Voltage (Air Discharge) (kV)
1	7.5	4	2	2	2
2	15	8	4	4	4
3	22.5	12	6	6	8
4	30	16	8	8	15

Operating temperature range	-40°C to +85°C
Storage temperature range	-55°C to +125°C
ESD Capability: IEC61000-4-2 Contact discharge IEC61000-4-2 Air discharge	8kV typical 15kV typical

**ENVIRONMENTAL SPECIFICATIONS**

	Test Conditions	Pass/Fail Criteria
Bias Humidity Test	85°C, 85% RH, $V_{DC(max)}$ , 1000hrs	$I_L$ % 10 $\mu$ A
Thermal Shock	-55°C to 125°C, 30 min Dwell, 1000 Cycles	$I_L$ % 10 $\mu$ A
Bias Heat Test	125°C, $V_{DC(max)}$ , 1000 hrs	$I_L$ % 10 $\mu$ A
Bias Low Temp Test	-55°C, $V_{DC(max)}$ , 1000 hrs	$I_L$ % 10 $\mu$ A
Solderability	250°C $\pm$ 5°C, 3 $\pm$ 1s	95% Coverage
Solder Heat	260°C, 10s	90% Coverage

### SOLDER REFLOW RECOMMENDATIONS

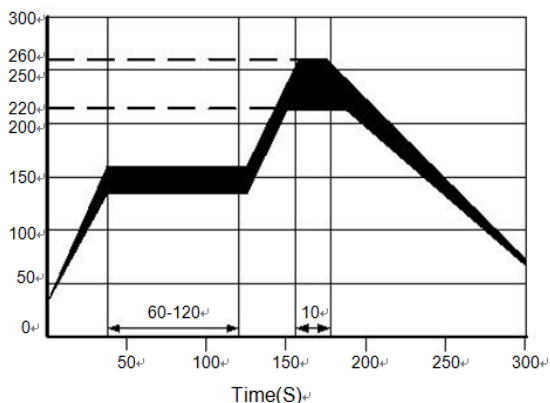

- Recommended reflow methods: IR, vapor phase oven, hot air oven.
- The device can be exposed to a maximum temperature of 260°C for 10 seconds.
- Devices can be cleaned using standard industry methods and solvents.

**Notes:** If reflow temperatures exceed the recommended profile, devices may not meet the performance requirements.

### PRODUCT DIMENSIONS

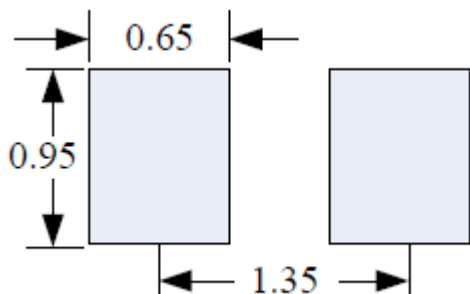
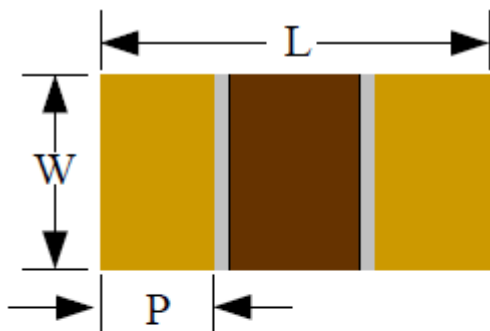

Size in mm  
**Land pattern**

Symbol	Millimeters			Inches		
	Min.	Typ.	Max.	Min.	Typ.	Max.
L	1.45	1.60	1.75	0.057	0.063	0.069
W	0.70	0.83	0.95	0.028	0.033	0.037
P	0.20	0.35	0.50	0.008	0.014	0.020
H	0.26	0.36	0.46	0.010	0.014	0.018

**TAPE AND REEL INFORMATION**

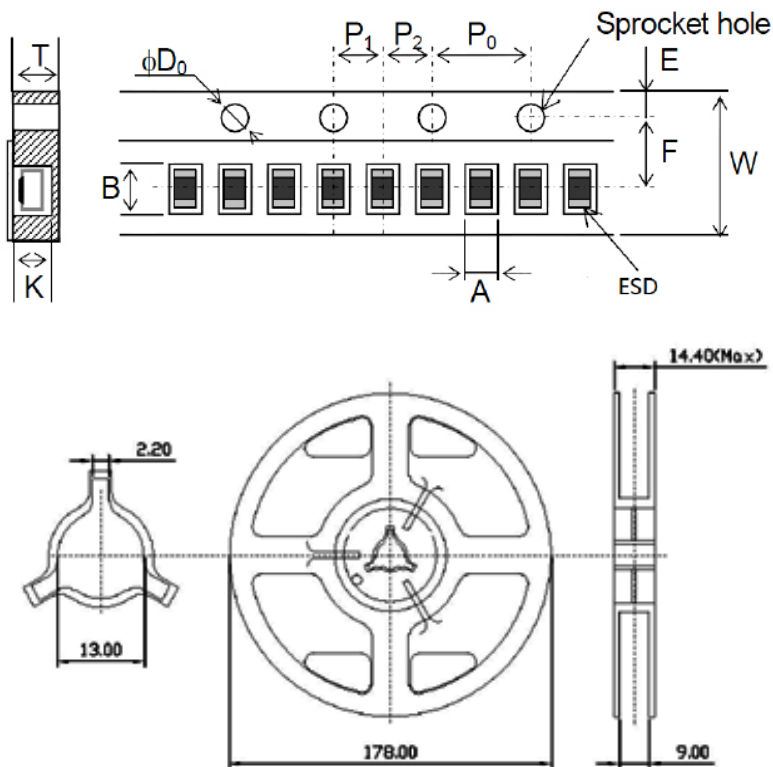

Symbol	Millimeters	Inches
A	1.00±0.03	0.039±0.001
B	1.90±0.03	0.075±0.001
W	8.00±0.10	0.315±0.004
F	3.50±0.05	0.138±0.002
E	1.75±0.10	0.069±0.004
P1	2.00±0.05	0.079±0.002
P2	2.00±0.05	0.079±0.002
P0	4.00±0.10	0.157±0.004
ΦD0	1.55±0.05	0.061±0.002
K	0.43±0.03	0.017±0.001
T	0.43±0.03	0.017±0.001

**PART NUMBERING SYSTEM**

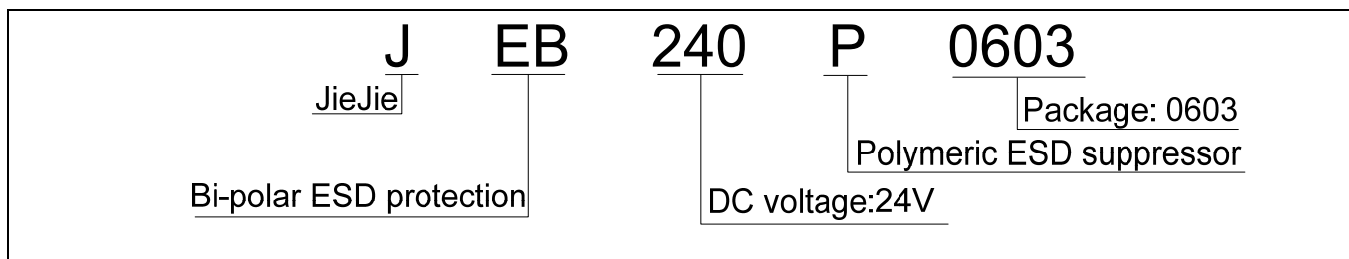

**ORDERING INFORMATION**

PART No.	PACKAGE TYPE	QUANTITY(PCS) REEL	DESCRIPTION
JEB240P0603	0603	5,000	7 inch reel pack

Information furnished in this document is believed to be accurate and reliable. However, Jiangsu JieJie Microelectronics Co.,Ltd assumes no responsibility for the consequences of use without consideration for such information nor use beyond it.

Information mentioned in this document is subject to change without notice, apart from that when an agreement is signed, Jiangsu JieJie complies with the agreement.

Products and information provided in this document have no infringement of patents. Jiangsu JieJie assumes no responsibility for any infringement of other rights of third parties which may result from the use of such products and information.

This document is the first version which is made in 7-Apr.-2021. This document supersedes and replaces all information previously supplied.

 is a registered trademark of Jiangsu JieJie Microelectronics Co.,Ltd.

Copyright ©2021 Jiangsu JieJie Microelectronics Co.,Ltd. Printed All rights reserved.