

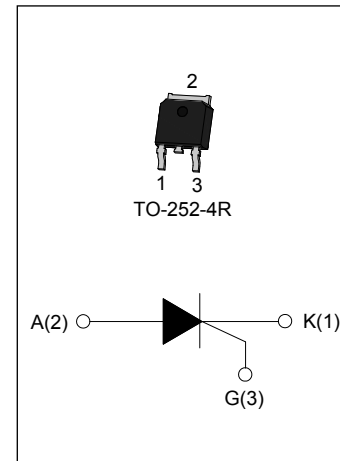

DESCRIPTION:

With high ability to withstand the shock loading of large current, JCT610/810 series of silicon controlled rectifiers provide high dv/dt rate with strong resistance to electromagnetic interference. They are especially recommended for use on solid state relay, motorcycle, power charger, T-tools etc. Package TO-252-4R is RoHS compliant. (2011/65/EU)



MAIN FEATURES

Symbol	JCT610	JCT810
V_{DRM}/V_{RRM}	600V	800V
$I_{T(RMS)}$	10A	
I_{GT}	$\leq 10mA$	

ABSOLUTE MAXIMUM RATINGS

Parameter	Symbol	Value	Unit
Storage junction temperature range	T_{stg}	-40-150	$^{\circ}C$
Operating junction temperature range	T_j	-40-150	$^{\circ}C$
Repetitive peak off-state voltage($T_j=25^{\circ}C$)	V_{DRM}	600/800	V
Repetitive peak reverse voltage($T_j=25^{\circ}C$)	V_{RRM}	600/800	V
RMS on-state current	TO-252-4R ($T_C=105^{\circ}C$) $I_{T(RMS)}$	10	A
Non repetitive surge peak on-state current ($t_p=10ms$)	I_{TSM}	120	A
I^2t value for fusing ($t_p=10ms$)	I^2t	72	A^2s
Critical rate of rise of on-state current ($I_G=2 \times I_{GT}$)	di/dt	50	$A/\mu s$
Peak gate current	I_{GM}	4	A
Average gate power dissipation	$P_{G(AV)}$	1	W
Peak gate power	P_{GM}	5	W

ELECTRICAL CHARACTERISTICS ($T_j=25^{\circ}\text{C}$ unless otherwise specified)

Symbol	Test Condition	Value			Unit
		MIN.	TYP.	MAX.	
I_{GT}	$V_D=12\text{V } R_L=33\Omega$	-	-	10	mA
V_{GT}		-	-	1.5	V
V_{GD}	$V_D=V_{DRM} T_j=150^{\circ}\text{C } R_L=3.3\text{K}\Omega$	0.2	-	-	V
I_L	$I_G=1.2I_{GT}$	-	-	40	mA
I_H	$I_T=500\text{mA}$	-	-	30	mA
dV/dt	$V_D=2/3V_{DRM}$ Gate Open $T_j=150^{\circ}\text{C}$	200	-	-	V/ μs

STATIC CHARACTERISTICS

Symbol	Parameter		Value(MAX)	Unit
V_{TM}	$I_{TM}=20\text{A } t_p=380\mu\text{s}$	$T_j=25^{\circ}\text{C}$	1.55	V
I_{DRM}	$V_D=V_{DRM} V_R=V_{RRM}$	$T_j=25^{\circ}\text{C}$	5	μA
I_{RRM}		$T_j=150^{\circ}\text{C}$	1	mA

THERMAL RESISTANCES

Symbol	Parameter		Value	Unit
$R_{th(j-c)}$	junction to case(AC)	TO-252-4R	2.0	$^{\circ}\text{C/W}$
$R_{th(j-a)}$	junction to ambient		70	

ORDERING INFORMATION

<p>J</p> <p>JieJie Microelectronics Co.,Ltd</p>	<p>CT</p> <p>SCRs</p> <p>6:$V_{DRM}/V_{RRM} \geq 600\text{V}$ 8:$V_{DRM}/V_{RRM} \geq 800\text{V}$</p>	<p>6</p>	<p>10</p> <p>$I_{T(RMS)}:10\text{A}$</p>	<p>K</p> <p>K: TO-252-4R KTR:TO-252-4R(Tape&Reel)</p>
--------------------------------------------------------	-----------------------------------------------------------------------------------------------------------------------------------------	-----------------	------------------------------------------------------------	----------------------------------------------------------------------

PACKAGE MECHANICAL DATA

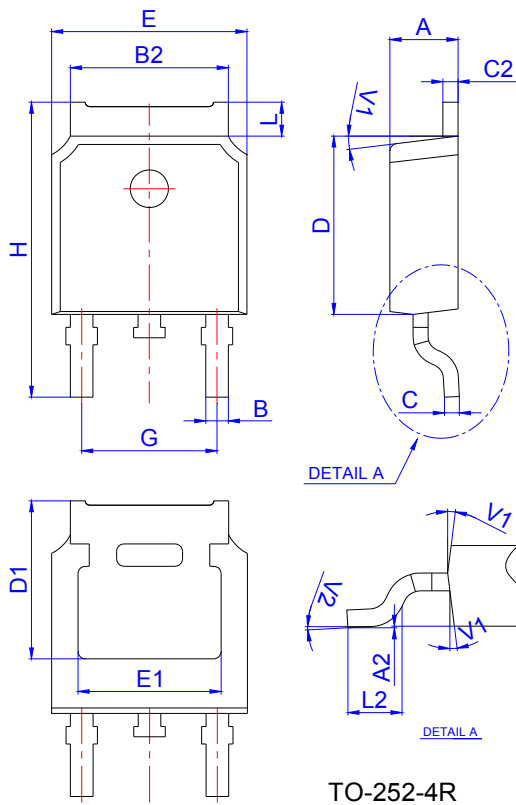

Ref.	Dimensions					
	Millimeters			Inches		
	Min.	Typ.	Max.	Min.	Typ.	Max.
A	2.10		2.50	0.083		0.098
A2	0		0.10	0		0.004
B	0.66		0.86	0.026		0.034
B2	5.18		5.48	0.202		0.216
C	0.40		0.60	0.016		0.024
C2	0.44		0.58	0.017		0.023
D	5.90		6.30	0.232		0.248
D1	5.30REF			0.209REF		
E	6.40		6.80	0.252		0.268
E1	4.63			0.182		
G	4.47		4.67	0.176		0.184
H	9.50		10.70	0.374		0.421
L	1.09		1.21	0.043		0.048
L2	1.35		1.65	0.053		0.065
V1		7°			7°	
V2	0°		6°	0°		6°

FOOTPRINT-TO-252-4R (dimensions in mm)

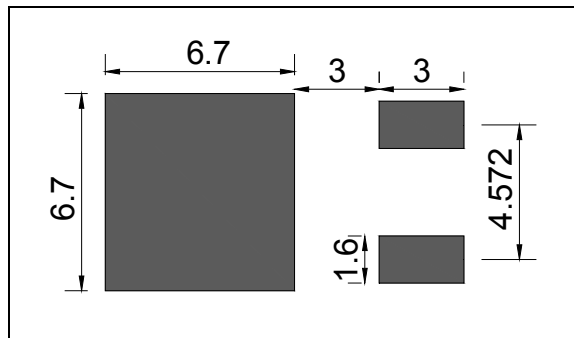

MARKING

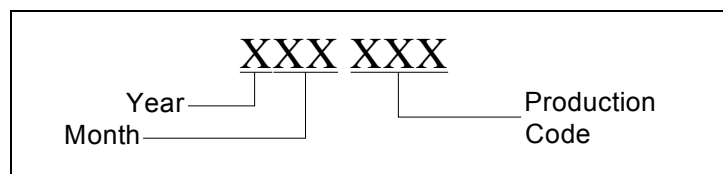
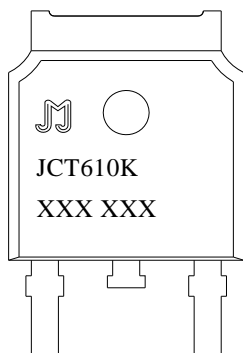

FIG.1 Maximum power dissipation versus RMS on-state current

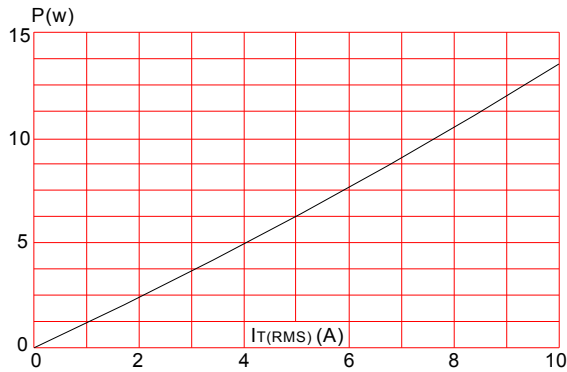

FIG.2: RMS on-state current versus ambient temperature (printed circuit board FR4,copper thickness:35μm)(full cycle)

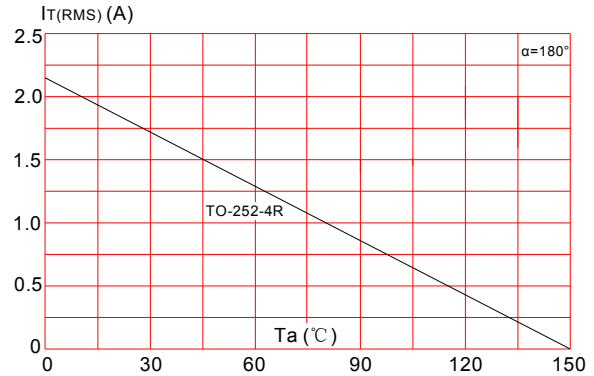

FIG.3: Surge peak on-state current versus number of cycles

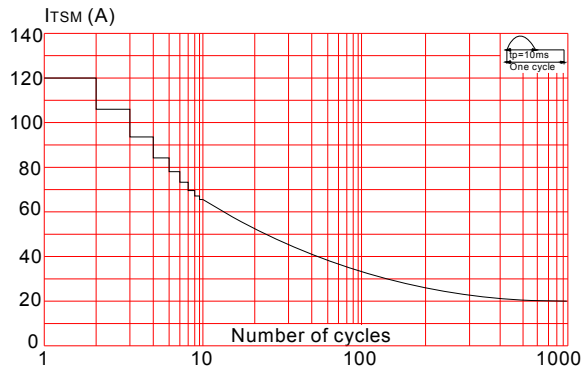

FIG.4: On-state characteristics (maximum values)

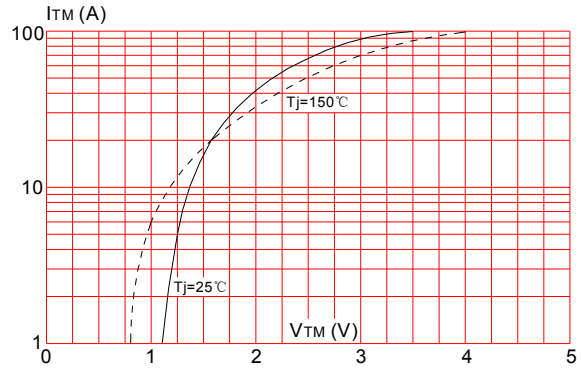

FIG.5: Non-repetitive surge peak on-state current for a sinusoidal pulse with width tp<10ms, and corresponding value of I²t (di/dt < 50A/μs)

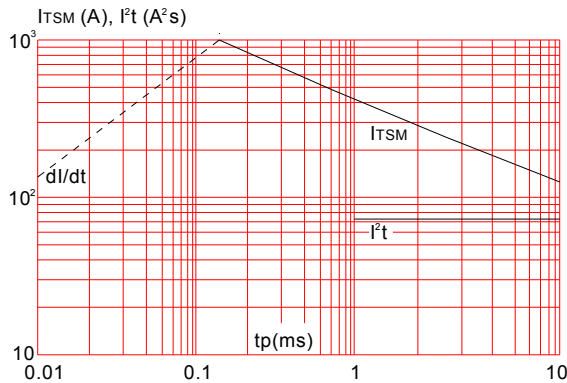
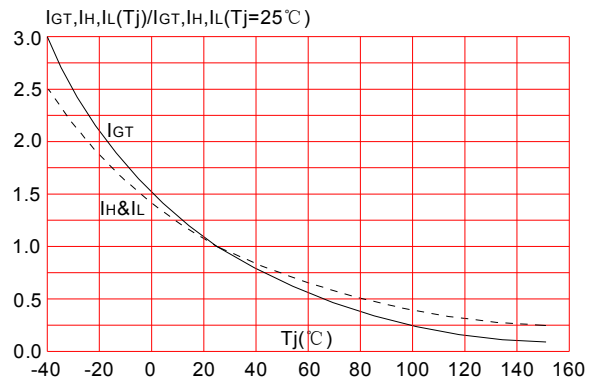
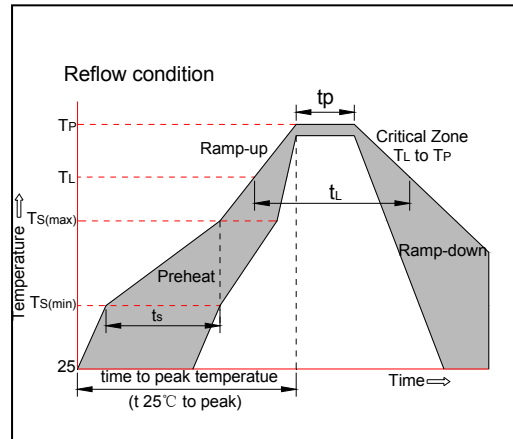

FIG.6: Relative variations of gate trigger current, holding current and latching current versus junction temperature



SOLDERING PARAMETERS

Reflow Condition		Pb-Free assembly (see figure at right)
Pre Heat	-Temperature Min ($T_{s(min)}$)	+150°C
	-Temperature Max($T_{s(max)}$)	+200°C
	-Time (Min to Max) (t_s)	60-180 secs.
Average ramp up rate (Liquidus Temp (T_L) to peak)		3°C/sec. Max
$T_{s(max)}$ to T_L - Ramp-up Rate		3°C/sec. Max
Reflow	-Temperature(T_L) (Liquidus)	+217°C
	-Temperature(t_L)	60-150 secs.
Peak Temp (T_p)		+260(+0/-5)°C
Time within 5°C of actual Peak Temp (t_p)		20-40secs.
Ramp-down Rate		6°C/sec. Max
Time 25°C to Peak Temp (T_p)		8 min. Max
Do not exceed		+260°C



Information furnished in this document is believed to be accurate and reliable. However, Jiangsu JieJie Microelectronics Co.,Ltd assumes no responsibility for the consequences of use without consideration for such information nor use beyond it. Information mentioned in this document is subject to change without notice, apart from that when an agreement is signed, Jiangsu JieJie complies with the agreement. Products and information provided in this document have no infringement of patents. Jiangsu JieJie assumes no responsibility for any infringement of other rights of third parties which may result from the use of such products and information. This document is the seventh version which is made in 25-Jan.-2019. This document supersedes and replaces all information previously supplied.

 is a registered trademark of Jiangsu JieJie Microelectronics Co.,Ltd.

Copyright ©2019 Jiangsu JieJie Microelectronics Co.,Ltd. Printed All rights reserved.

单击下面可查看定价，库存，交付和生命周期等信息

[>>JW\(捷捷微\)](#)