



Description

JMT N-channel MOSFET

Features

- $V_{DS}=60V$, $I_D=0.2A$
 $R_{DS(ON)} < 2.1\Omega @ V_{GS} = 10V$
 $R_{DS(ON)} < 2.7\Omega @ V_{GS} = 4.5V$
- Advanced Trench Technology
- Excellent $R_{DS(ON)}$ and Low Gate Charge
- Lead free product is acquired
- ESD Protected: 2KV

Application

- Battery Operated Systems
- Direct logic-level Interface: TTL/CMOS
- Solid-State Relays

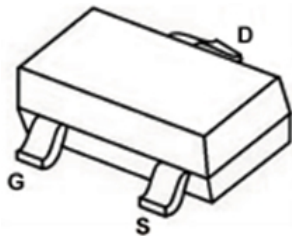

SOT-323 top view

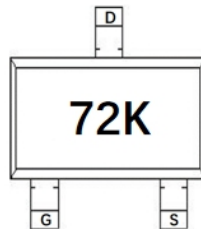

Marking and pin Assignment

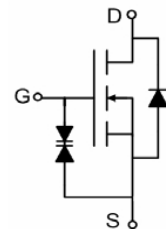

Schematic diagram

Package Marking and Ordering Information

Device Marking	Device	OUTLINE	Device Package	Reel Size	Reel (PCS)	Per Carton (PCS)
72K	JMTLA2N7002KS	TAPING	SOT-323	7inch	3000	180000

Absolute Maximum Ratings ($T_A=25^\circ C$ unless otherwise specified)

Symbol	Parameter	Max.	Units
V_{DSS}	Drain-Source Voltage	60	V
V_{GSS}	Gate-Source Voltage	± 20	V
I_D	Continuous Drain Current	$T_A = 25^\circ C$	0.2
		$T_A = 100^\circ C$	0.13
I_{DM}	Pulsed Drain Current ^{note1}	0.8	A
P_D	Power Dissipation	$T_A = 25^\circ C$	0.14
$R_{\theta JA}$	Thermal Resistance, Junction to Ambient	893	$^\circ C/W$
T_J, T_{STG}	Operating and Storage Temperature Range	-55 to +150	$^\circ C$



Electrical Characteristics (T_J=25°C unless otherwise specified)

Symbol	Parameter	Test Condition	Min.	Typ.	Max.	Units
Off Characteristic						
V _{(BR)DSS}	Drain-Source Breakdown Voltage	V _{GS} =0V, I _D = 10μA	60	-	-	V
I _{DSS}	Zero Gate Voltage Drain Current	V _{DS} =60V, V _{GS} = 0V,	-	-	1	μA
I _{GSS}	Gate to Body Leakage Current	V _{DS} =0V, V _{GS} = ±20V	-	-	±10	uA
On Characteristics						
V _{GS(th)}	Gate Threshold Voltage	V _{DS} = V _{GS} , I _D = 250μA	1	-	2.5	V
R _{DS(on)}	Static Drain-Source on-Resistance <small>note2</small>	V _{GS} =10V, I _D =0.3A	-	1.6	2.1	Ω
		V _{GS} =4.5V, I _D =0.2A	-	1.9	2.7	
Dynamic Characteristics						
C _{iss}	Input Capacitance	V _{DS} = 25V, V _{GS} = 0V, f = 1.0MHz	-	28	-	pF
C _{oss}	Output Capacitance		-	11	-	pF
C _{rss}	Reverse Transfer Capacitance		-	4	-	pF
Q _g	Total Gate Charge	V _{DS} = 10V, I _D = 0.3A, V _{GS} = 4.5V	-	1.7	-	nC
Q _{gs}	Gate-Source Charge		-	0.3	-	nC
Q _{gd}	Gate-Drain("Miller") Charge		-	0.6	-	nC
Switching Characteristics						
t _{d(on)}	Turn-on Delay Time	V _{DD} = 30V, I _D =0.2A, R _{GEN} = 10Ω, V _{GS} =10V,	-	10	-	ns
t _r	Turn-on Rise Time		-	50	-	ns
t _{d(off)}	Turn-off Delay Time		-	17	-	ns
t _f	Turn-off Fall Time		-	10	-	ns
Drain-Source Diode Characteristics and Maximum Ratings						
I _S	Maximum Continuous Drain to Source Diode Forward Current		-	-	0.2	A
I _{SM}	Maximum Pulsed Drain to Source Diode Forward Current		-	-	0.8	A
V _{SD}	Drain to Source Diode Forward Voltage	V _{GS} = 0V, I _S =0.2A	-	-	1.2	V

Notes:1. Repetitive Rating: Pulse Width Limited by Maximum Junction Temperature

2. Pulse Test: Pulse Width≤300μs, Duty Cycle≤2%



Typical Performance Characteristics

Figure 1: Output Characteristics

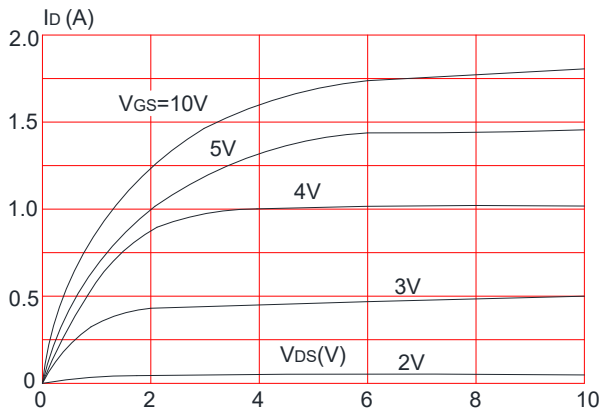

Figure 2: Typical Transfer Characteristics

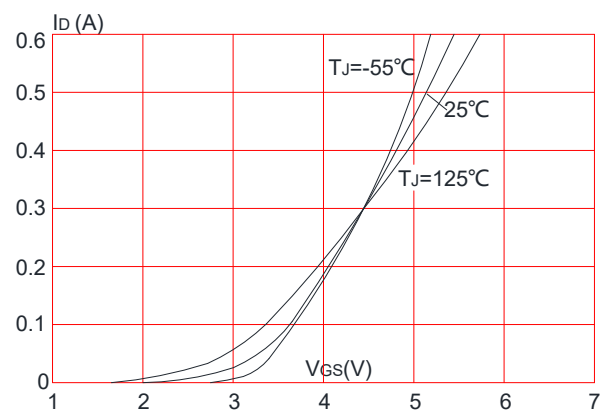

Figure 3: On-resistance vs. Drain Current

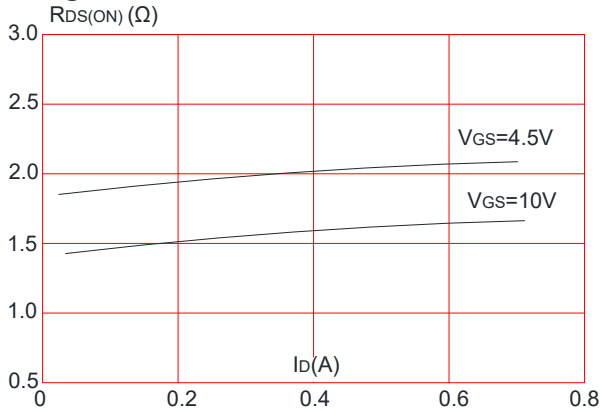

Figure 4: Body Diode Characteristics

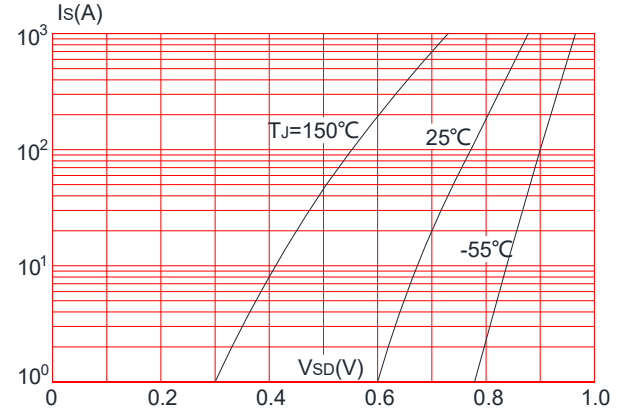

Figure 5: Gate Charge Characteristics

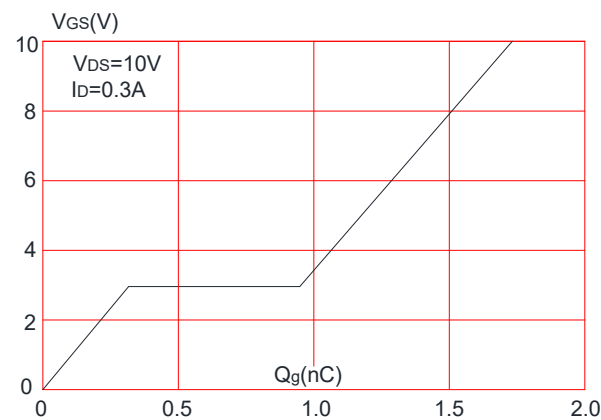

Figure 6: Capacitance Characteristics

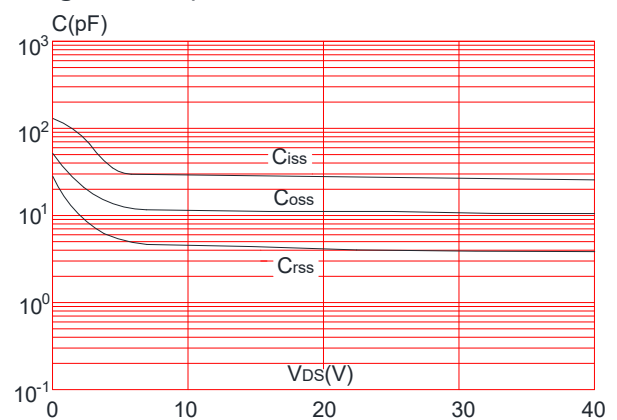



Figure 7: Normalized Breakdown Voltage vs. Junction Temperature

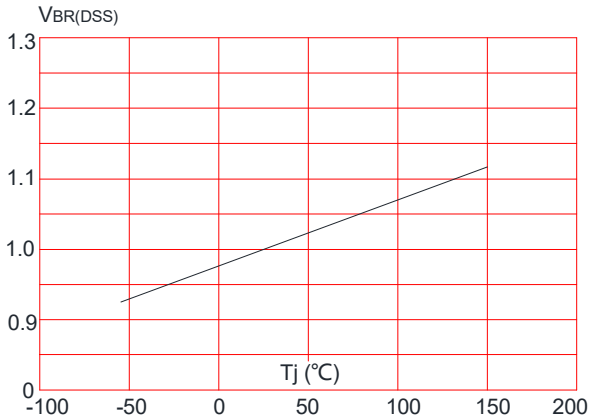

Figure 8: Normalized on Resistance vs. Junction Temperature

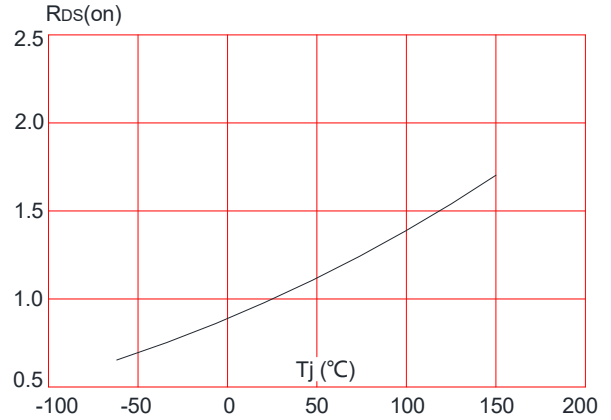

Figure 9: Maximum Safe Operating Area

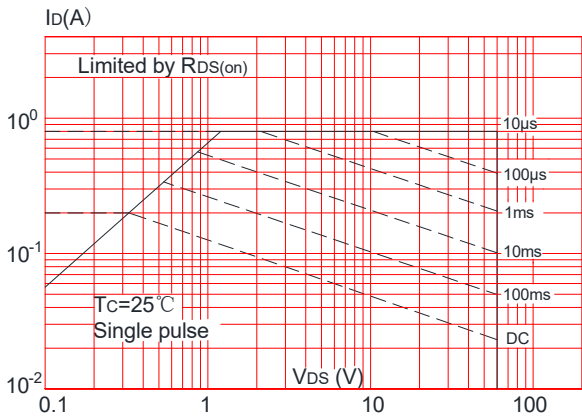

Figure 10: Maximum Continuous Drain Current vs. Case Temperature

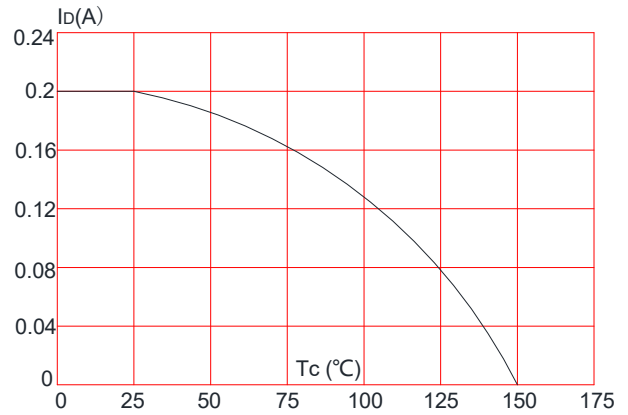
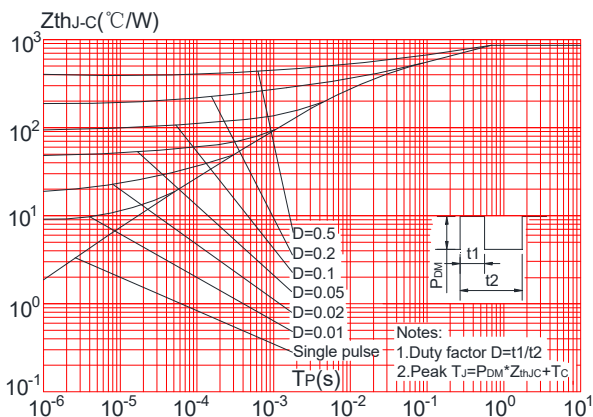

Figure.11: Maximum Effective Transient Thermal Impedance, Junction-to-Case



Test Circuit

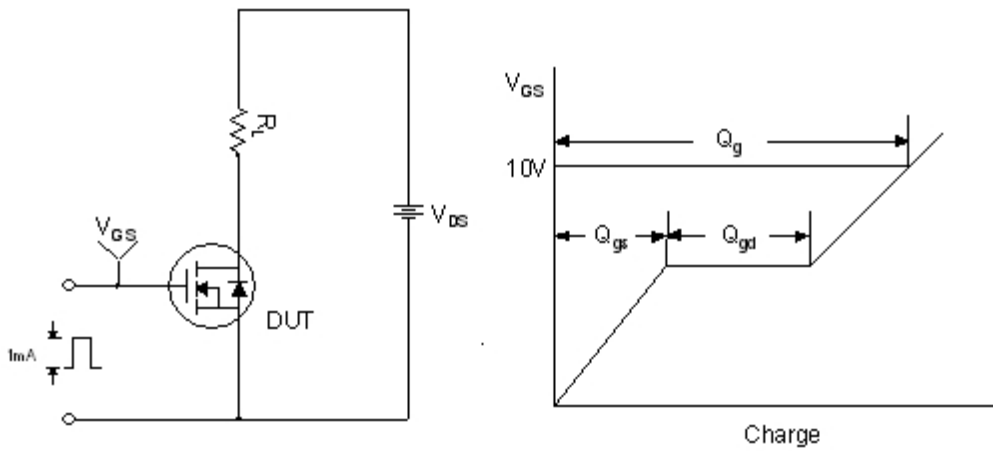

Figure 1. Gate Charge Test Circuit & Waveform

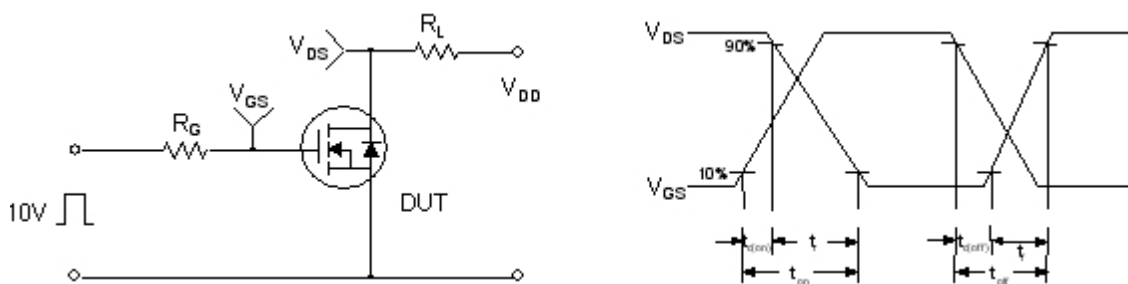

Figure 2. Resistive Switching Test Circuit & Waveforms

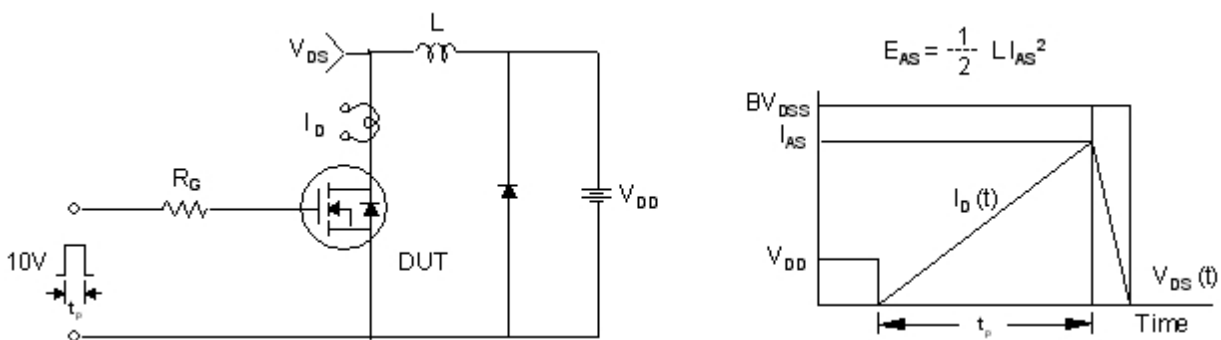
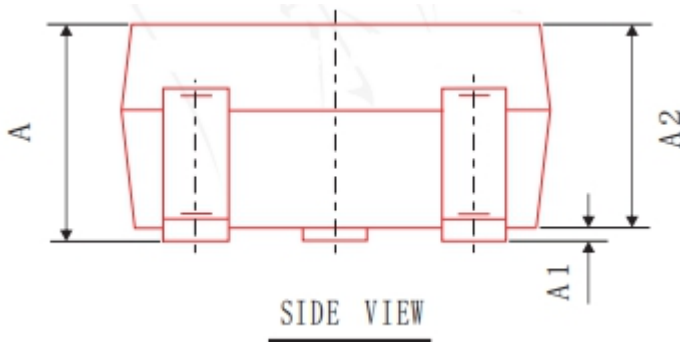
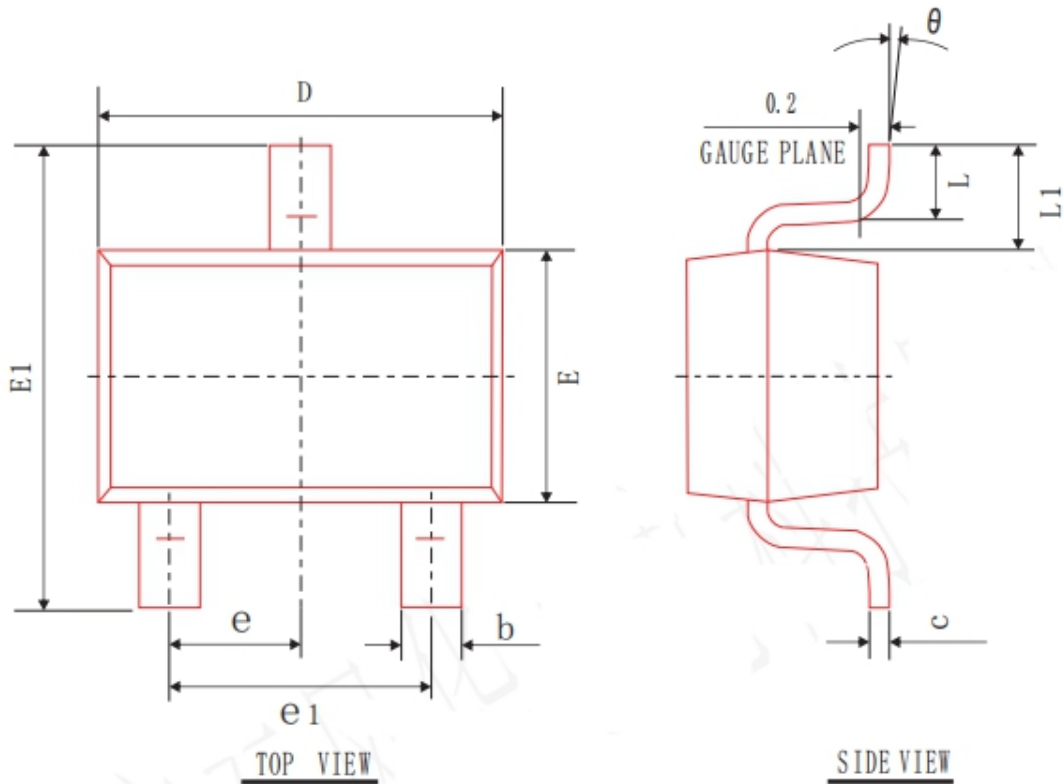

Figure 3. Unclamped Inductive Switching Test Circuit & Waveforms



Package Mechanical Data-SOT-323



COMMON DIMENSIONS
(UNITS OF MEASURE=mm)

SYMBOL	MIN	NOM	MAX
A	0.90	1.00	1.10
A1	0.00	0.05	0.10
A2	0.90	0.95	1.00
b	0.20	0.25	0.30
c	0.08	0.10	0.15
e1	1.20	1.30	1.40
D	2.00	2.10	2.20
E	1.15	1.25	1.35
E1	2.15	2.30	2.45
L	0.26	0.36	0.46
θ	0°	4°	8°
L1	0.525 REF		
e	0.65 TYP		



Information furnished in this document is believed to be accurate and reliable. However, Jiangsu JieJie Microelectronics Co.,Ltd assumes no responsibility for the consequences of use without consideration for such information nor use beyond it.

Information mentioned in this document is subject to change without notice, apart from that when an agreement is signed, Jiangsu JieJie complies with the agreement.

Products and information provided in this document have no infringement of patents. Jiangsu JieJie assumes no responsibility for any infringement of other rights of third parties which may result from the use of such products and information.

 is a registered trademark of Jiangsu JieJie Microelectronics Co.,Ltd.
Copyright ©2021 Jiangsu JieJie Microelectronics Co.,Ltd. Printed All rights reserved.

单击下面可查看定价，库存，交付和生命周期等信息

[>>JW\(捷捷微\)](#)