



## 40V 5.7mΩ N-Ch Power MOSFET

### Features

- Ultra-low  $R_{DS(ON)}$
- Low Gate Charge
- High Current Capability
- 100% UIS Tested, 100%  $R_g$  Tested

### Product Summary

Parameter	Typ.	Unit
$V_{DS}$	40	V
$V_{GS(th)}$	1.7	V
$I_D$ (@ $V_{GS} = 10V$ ) <sup>(1)</sup>	43	A
$R_{DS(ON)}$ (@ $V_{GS} = 10V$ )	5.7	mΩ

### Applications

- Power Management in Computing, CE, IE 4.0, Communications
- Current Switching in DC/DC & AC/DC (SR) Sub-systems
- Load Switching, Quick/Wireless Charging, Motor Driving

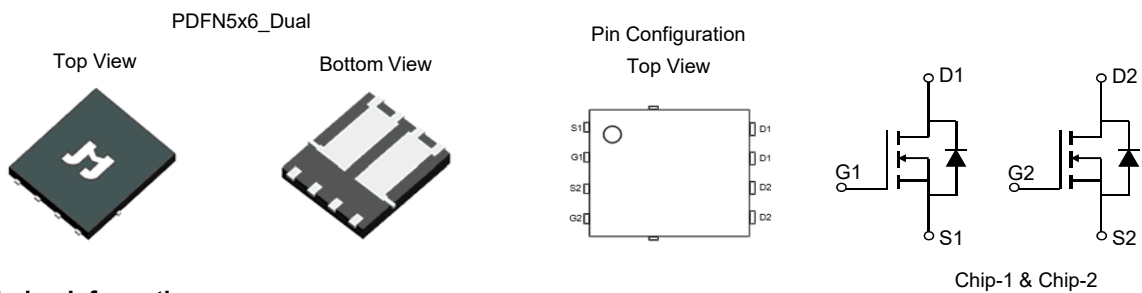

### Ordering Information

Device	Package	# of Pins	Marking	MSL	$T_J$ (°C)	Media	Quantity (pcs)
JMSL0406AGD-13	PDFN5x6_Dual	8	L0406AD	1	-55 to 150	13-inch Reel	3000

### Absolute Maximum Ratings (@ $T_A = 25^\circ C$ unless otherwise specified)

Parameter	Symbol	Value	Unit
Drain-to-Source Voltage	$V_{DS}$	40	V
Gate-to-Source Voltage	$V_{GS}$	±20	V
Continuous Drain Current <sup>(1)</sup>	$I_D$	$T_C = 25^\circ C$	43
		$T_C = 100^\circ C$	27
Pulsed Drain Current <sup>(2)</sup>	$I_{DM}$	158	A
Avalanche Current <sup>(3)</sup>	$I_{AS}$	21	A
Avalanche Energy <sup>(3)</sup>	$E_{AS}$	22	mJ
Power Dissipation <sup>(4)</sup>	$P_D$	$T_C = 25^\circ C$	20
		$T_C = 100^\circ C$	8.1
Junction & Storage Temperature Range	$T_J, T_{STG}$	-55 to 150	°C

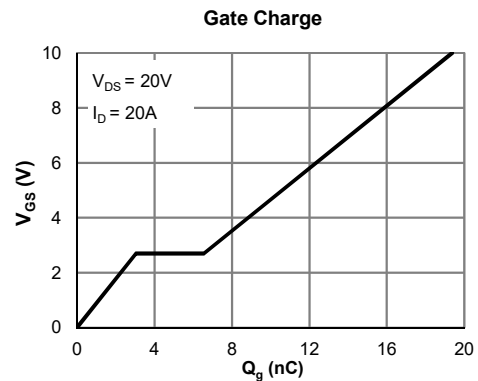
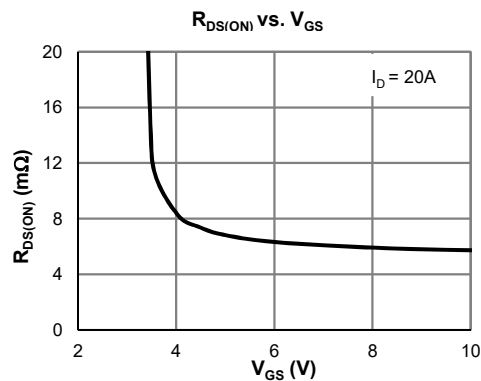

**Electrical Characteristics** (@  $T_J = 25^\circ\text{C}$  unless otherwise specified)

Parameter	Symbol	Conditions	Min.	Typ.	Max.	Unit
<b>STATIC PARAMETERS</b>						
Drain-Source Breakdown Voltage	$V_{(BR)DSS}$	$I_D = 250\mu\text{A}$ , $V_{GS} = 0\text{V}$	40			V
Zero Gate Voltage Drain Current	$I_{DSS}$	$V_{DS} = 32\text{V}$ , $V_{GS} = 0\text{V}$ $T_J = 55^\circ\text{C}$			1.0 5.0	$\mu\text{A}$
Gate-Body Leakage Current	$I_{GSS}$	$V_{DS} = 0\text{V}$ , $V_{GS} = \pm 20\text{V}$			$\pm 100$	nA
Gate Threshold Voltage	$V_{GS(th)}$	$V_{DS} = V_{GS}$ , $I_D = 250\mu\text{A}$	1.2	1.7	2.5	V
Static Drain-Source ON-Resistance	$R_{DS(on)}$	$V_{GS} = 10\text{V}$ , $I_D = 20\text{A}$		5.7	6.9	$\text{m}\Omega$
		$V_{GS} = 4.5\text{V}$ , $I_D = 15\text{A}$		7.2	9.5	$\text{m}\Omega$
Forward Transconductance	$g_{FS}$	$V_{DS} = 5\text{V}$ , $I_D = 20\text{A}$		95		S
Diode Forward Voltage	$V_{SD}$	$I_S = 1\text{A}$ , $V_{GS} = 0\text{V}$		0.71	1.0	V
Diode Continuous Current	$I_S$	$T_C = 25^\circ\text{C}$			20	A
<b>DYNAMIC PARAMETERS</b> <sup>(5)</sup>						
Input Capacitance	$C_{iss}$	$V_{GS} = 0\text{V}$ , $V_{DS} = 20\text{V}$ , $f = 1\text{MHz}$		1227		pF
Output Capacitance	$C_{oss}$			526		pF
Reverse Transfer Capacitance	$C_{rss}$			55		pF
Gate Resistance	$R_g$	$V_{GS} = 0\text{V}$ , $V_{DS} = 0\text{V}$ , $f = 1\text{MHz}$		2.7		$\Omega$
<b>SWITCHING PARAMETERS</b> <sup>(5)</sup>						
Total Gate Charge (@ $V_{GS} = 10\text{V}$ )	$Q_g$	$V_{GS} = 0$ to $10\text{V}$ $V_{DS} = 20\text{V}$ , $I_D = 20\text{A}$		19.4		nC
Total Gate Charge (@ $V_{GS} = 4.5\text{V}$ )	$Q_g$			9.7		nC
Gate Source Charge	$Q_{gs}$			3.1		nC
Gate Drain Charge	$Q_{gd}$			3.5		nC
Turn-On Delay Time	$t_{D(on)}$	$V_{GS} = 10\text{V}$ , $V_{DS} = 20\text{V}$ $R_L = 1.0\Omega$ , $R_{GEN} = 6\Omega$		5.0		ns
Turn-On Rise Time	$t_r$			7.0		ns
Turn-Off Delay Time	$t_{D(off)}$			23		ns
Turn-Off Fall Time	$t_f$			14.8		ns
Body Diode Reverse Recovery Time	$t_{rr}$		$I_F = 15\text{A}$ , $dI_F/dt = 100\text{A}/\mu\text{s}$		26	
Body Diode Reverse Recovery Charge	$Q_{rr}$	$I_F = 15\text{A}$ , $dI_F/dt = 100\text{A}/\mu\text{s}$		14.0		nC

**Thermal Performance**

Parameter	Symbol	Typ.	Max.	Unit
Thermal Resistance, Junction-to-Ambient	$R_{\theta JA}$	50	60	$^\circ\text{C}/\text{W}$
Thermal Resistance, Junction-to-Case	$R_{\theta JC}$	5.1	6.2	$^\circ\text{C}/\text{W}$

**Notes:**

1. Computed continuous current assumes the condition of  $T_{J\_Max}$  while the actual continuous current depends on the thermal & electro-mechanical application board design.
2. This single-pulse measurement was taken under  $T_{J\_Max} = 150^\circ\text{C}$ .
3. This single-pulse measurement was taken under the following condition [ $L = 100\mu\text{H}$ ,  $V_{GS} = 10\text{V}$ ,  $V_{DS} = 20\text{V}$ ] while its value is limited by  $T_{J\_Max} = 150^\circ\text{C}$ .
4. The power dissipation  $P_D$  is based on  $T_{J\_Max} = 150^\circ\text{C}$ .
5. This value is guaranteed by design hence it is not included in the production test.

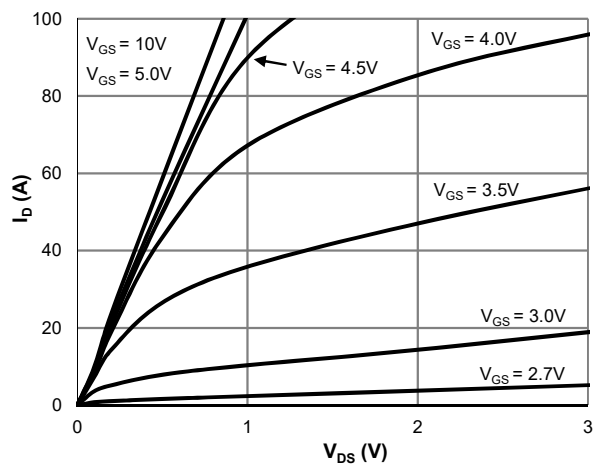
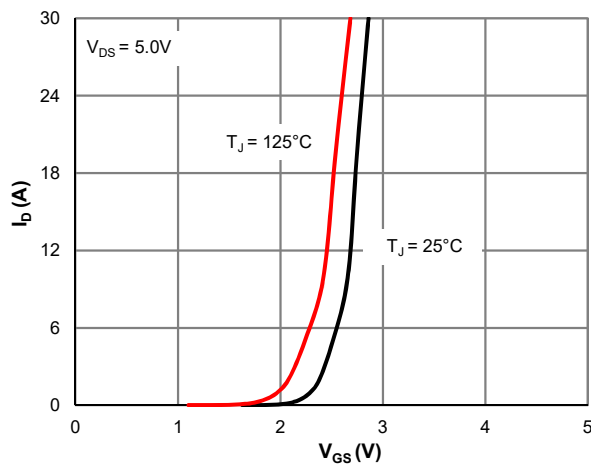
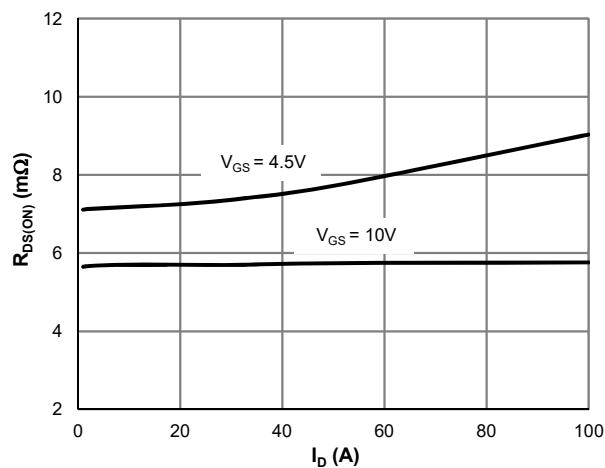
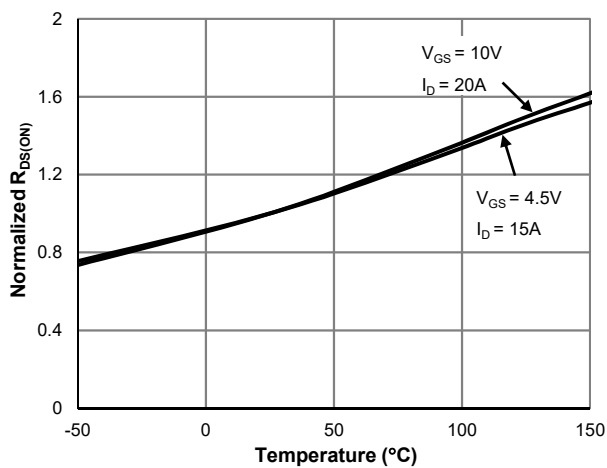
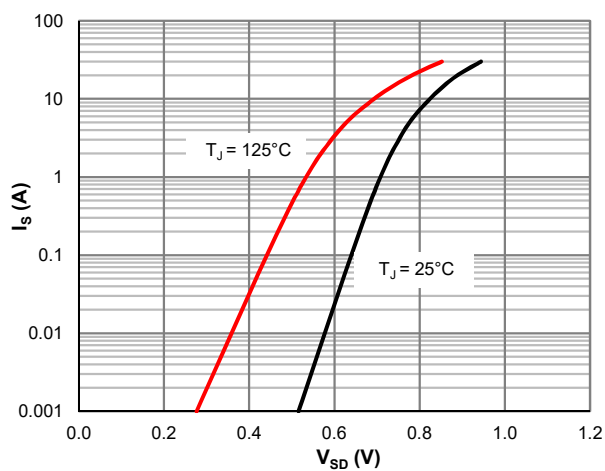
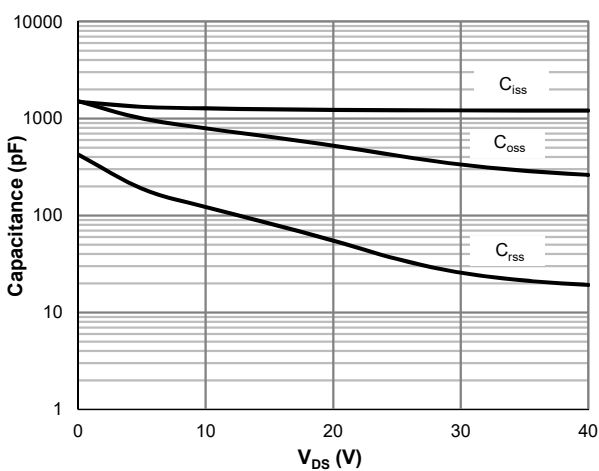
**Typical Electrical & Thermal Characteristics**

**Figure 1: Saturation Characteristics**

**Figure 2: Transfer Characteristics**

**Figure 3:  $R_{DS(ON)}$  vs. Drain Current**

**Figure 4:  $R_{DS(ON)}$  vs. Junction Temperature**

**Figure 5: Body-Diode Characteristics**

**Figure 6: Capacitance Characteristics**



### Typical Electrical & Thermal Characteristics

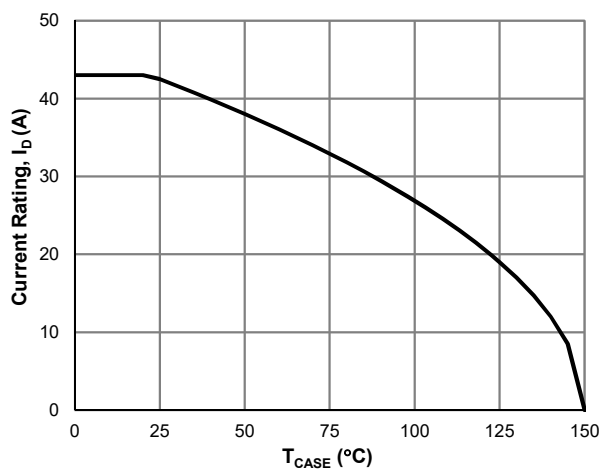

Figure 7: Current De-rating

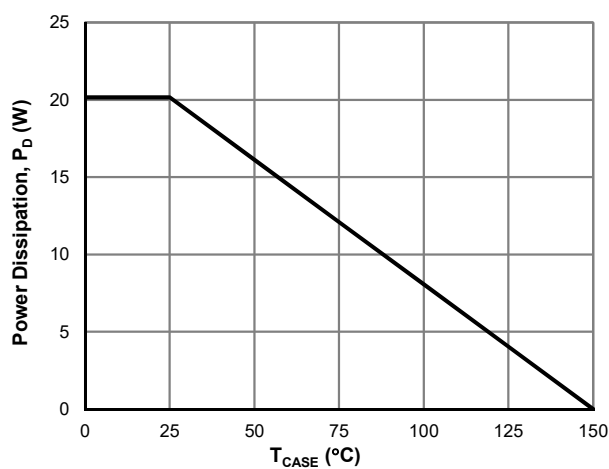

Figure 8: Power De-rating

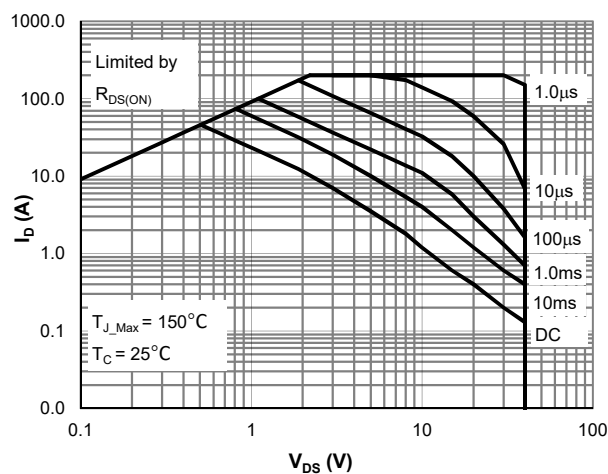

Figure 9: Maximum Safe Operating Area

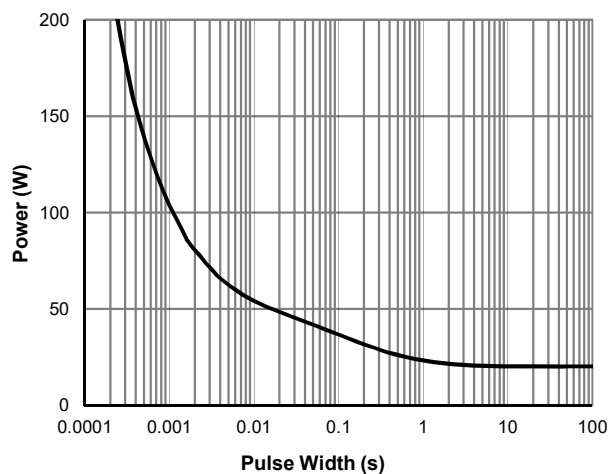

Figure 10: Single Pulse Power Rating, Junction-to-Case

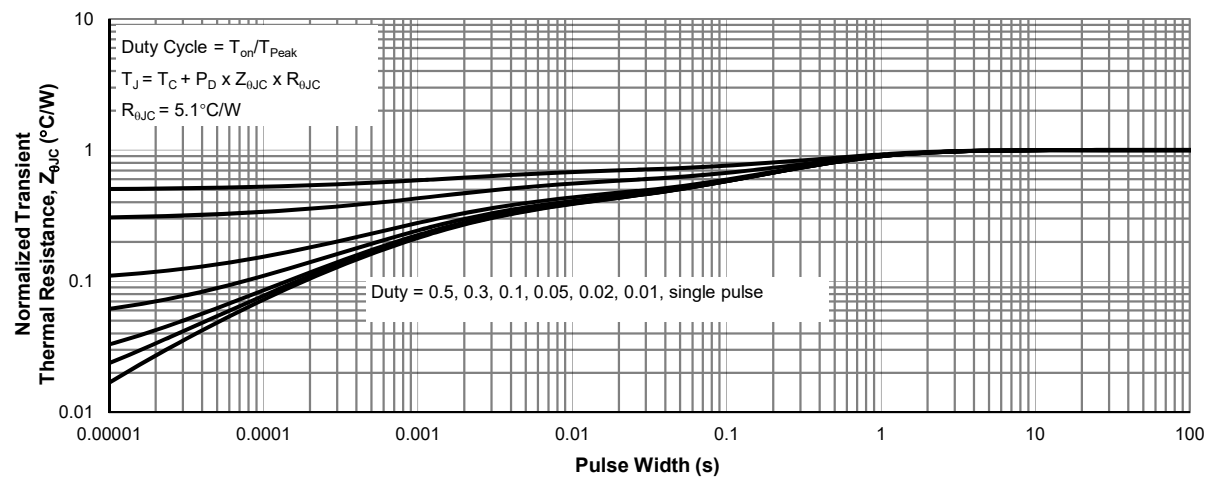
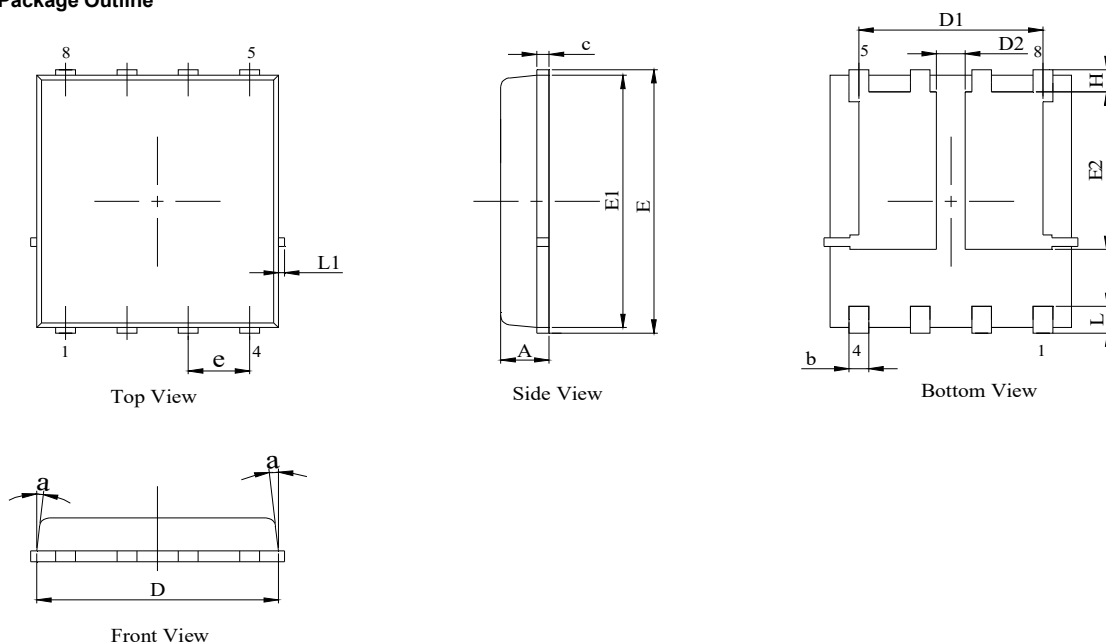
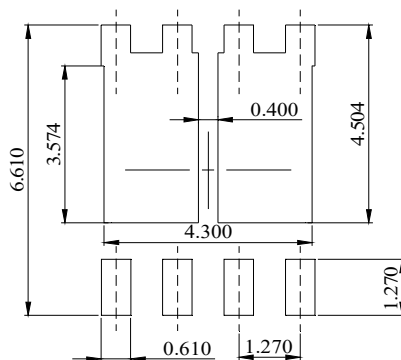

Figure 11: Normalized Maximum Transient Thermal Impedance

**PDFN5x6\_Dual Package Information**
**Package Outline**

**NOTES:**

1. Dimension and tolerance per ASME Y14.5M, 1994.
2. All dimensions in millimeter (angle in degree).
3. Dimensions D and E1 do not include mold flash protrusions or gate burrs.

DIM.	MILLIMETER	
	MIN.	MAX.
A	0.90	1.10
b	0.33	0.51
c	0.23	0.33
D	4.80	5.40
D1	3.61	4.25
D2	0.50	0.70
E	5.90	6.25
E1	5.55	5.80
E2	3.35	3.78
e	1.27 BSC	
H	0.41	0.80
L	0.51	0.80
L1		0.15
a	0°	12°

**Recommended Footprint**

DIMENSIONS: MILLIMETERS

单击下面可查看定价，库存，交付和生命周期等信息

[>>JW\(捷捷微\)](#)