



**-100V 36mΩ P-Ch Power MOSFET**

**Features**

- Low On-Resistance
- Excellent Gate Charge x  $R_{DS(ON)}$  Product (FOM)
- Pb-Free Lead Plating
- RoHS and Halogen-Free Compliant
- 100% UIS Tested, 100%  $R_g$  Tested

**Product Summary**

Parameter	Value	Unit
$V_{DS}$	-100	V
$V_{GS(th\_Typ)}$	-2.0	V
$I_D$ (@ $V_{GS} = -10V$ ) <sup>(1)</sup>	-27	A
$R_{DS(ON\_Typ)}$ (@ $V_{GS} = -10V$ )	36	mΩ
$R_{DS(ON\_Typ)}$ (@ $V_{GS} = -4.5V$ )	48	mΩ

**Applications**

- Battery Management
- DC/DC in Telecoms and Industrial
- Hard Switching and High Speed Circuit

PDFN5x6-8L

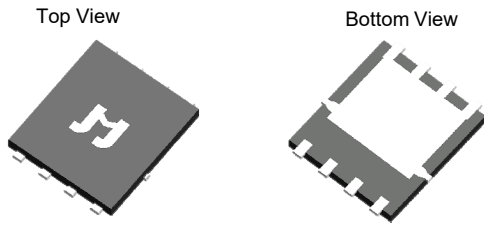

Pin Configuration  
Top View

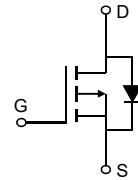
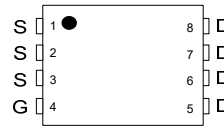

**Ordering Information**

Device	Package	# of Pins	Marking	MSL	$T_J$ (°C)	Media	Quantity (pcs)
JMPL1050AG-13	PDFN5x6-8L	8	PL1050A	1	-55 to 150	13-inch Reel	3000

**Absolute Maximum Ratings** (@  $T_A = 25^\circ C$  unless otherwise specified)

Parameter	Symbol	Value	Unit
Drain-to-Source Voltage	$V_{DS}$	-100	V
Gate-to-Source Voltage	$V_{GS}$	±20	V
Continuous Drain Current <sup>(1)</sup>	$I_D$	$T_C = 25^\circ C$	-27
		$T_C = 100^\circ C$	-17
Pulsed Drain Current <sup>(2)</sup>	$I_{DM}$	-82	A
Avalanche Current <sup>(3)</sup>	$I_{AS}$	-27	A
Avalanche Energy <sup>(3)</sup>	$E_{AS}$	109	mJ
Power Dissipation <sup>(4)</sup>	$P_D$	$T_C = 25^\circ C$	78
		$T_C = 100^\circ C$	31
Junction & Storage Temperature Range	$T_J, T_{STG}$	-55 to 150	°C

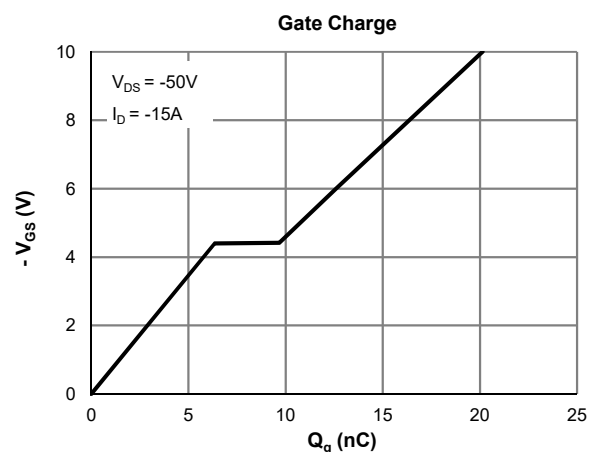
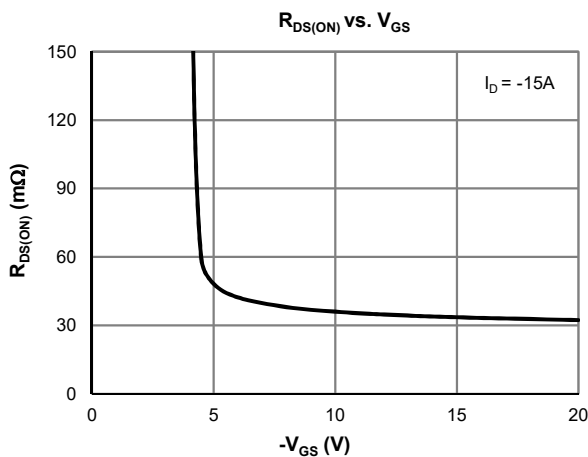

**Electrical Characteristics** (@  $T_J = 25^\circ\text{C}$  unless otherwise specified)

Parameter	Symbol	Conditions	Min.	Typ.	Max.	Unit
<b>STATIC PARAMETERS</b>						
Drain-Source Breakdown Voltage	$V_{(BR)DSS}$	$I_D = -250\mu\text{A}, V_{GS} = 0\text{V}$	-100			V
Zero Gate Voltage Drain Current	$I_{DSS}$	$V_{DS} = -80\text{V}, V_{GS} = 0\text{V}$ $T_J = 55^\circ\text{C}$			-1.0 -5.0	$\mu\text{A}$
Gate-Body Leakage Current	$I_{GSS}$	$V_{DS} = 0\text{V}, V_{GS} = \pm 20\text{V}$			$\pm 100$	nA
Gate Threshold Voltage	$V_{GS(th)}$	$V_{DS} = V_{GS}, I_D = -250\mu\text{A}$	-1.0	-2.0	-3.0	V
Static Drain-Source ON-Resistance	$R_{DS(ON)}$	$V_{GS} = -10\text{V}, I_D = -15\text{A}$		36	50	$\text{m}\Omega$
		$V_{GS} = -4.5\text{V}, I_D = -10\text{A}$		48	65	$\text{m}\Omega$
Forward Transconductance	$g_{FS}$	$V_{DS} = -5\text{V}, I_D = -15\text{A}$		30		S
Diode Forward Voltage	$V_{SD}$	$I_S = -1\text{A}, V_{GS} = 0\text{V}$		-0.7	-1.0	V
Diode Continuous Current	$I_S$	$T_C = 25^\circ\text{C}$			-78	A

**DYNAMIC PARAMETERS** <sup>(5)</sup>

Input Capacitance	$C_{iss}$	$V_{GS} = 0\text{V}, V_{DS} = -50\text{V}, f = 1\text{MHz}$		1412		pF
Output Capacitance	$C_{oss}$			222		pF
Reverse Transfer Capacitance	$C_{rss}$			2.6		pF
Gate Resistance	$R_g$	$V_{GS} = 0\text{V}, V_{DS} = 0\text{V}, f = 1\text{MHz}$		10.2		$\Omega$

**SWITCHING PARAMETERS** <sup>(5)</sup>

Total Gate Charge (@ $V_{GS} = -10\text{V}$ )	$Q_g$	$V_{GS} = 0 \text{ to } -10\text{V}$ $V_{DS} = -50\text{V}, I_D = -15\text{A}$		20		nC
Total Gate Charge (@ $V_{GS} = -6.0\text{V}$ )	$Q_g$			12.6		nC
Gate Source Charge	$Q_{gs}$			6.4		nC
Gate Drain Charge	$Q_{gd}$			3.3		nC
Turn-On DelayTime	$t_{D(on)}$	$V_{GS} = -10\text{V}, V_{DS} = -50\text{V}$ $R_L = 3.3\Omega, R_{GEN} = 6\Omega$		10.7		ns
Turn-On Rise Time	$t_r$			56		ns
Turn-Off DelayTime	$t_{D(off)}$			45		ns
Turn-Off Fall Time	$t_f$			81		ns
Body Diode Reverse Recovery Time	$t_{rr}$		$I_F = -15\text{A}, dI_F/dt = -100\text{A}/\mu\text{s}$		51	
Body Diode Reverse Recovery Charge	$Q_{rr}$	$I_F = -15\text{A}, dI_F/dt = -100\text{A}/\mu\text{s}$		130		nC

**Thermal Performance**

Parameter	Symbol	Typ.	Max.	Unit
Thermal Resistance, Junction-to-Ambient	$R_{\theta JA}$	47	55	$^\circ\text{C}/\text{W}$
Thermal Resistance, Junction-to-Case	$R_{\theta JC}$	1.2	1.6	$^\circ\text{C}/\text{W}$

**Notes:**

1. Computed continuous current assumes the condition of  $T_{J\_Max}$  while the actual continuous current depends on the thermal & electro-mechanical application board design.
2. This single-pulse measurement was taken under  $T_{J\_Max} = 150^\circ\text{C}$ .
3. This single-pulse measurement was taken under the following condition [ $L = 300\mu\text{H}, V_{GS} = -10\text{V}, V_{DD} = -50\text{V}$ ] while its value is limited by  $T_{J\_Max} = 150^\circ\text{C}$ .
4. The power dissipation  $P_D$  is based on  $T_{J\_Max} = 150^\circ\text{C}$ .
5. This value is guaranteed by design hence it is not included in the production test.

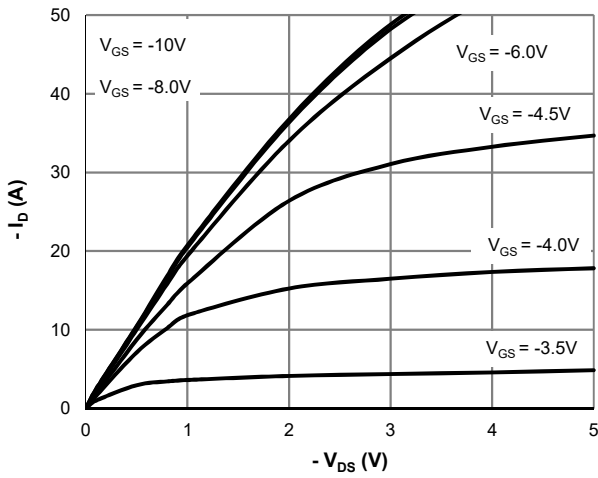
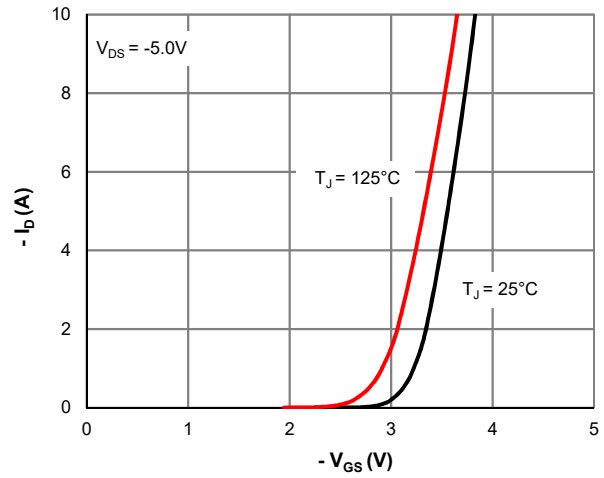
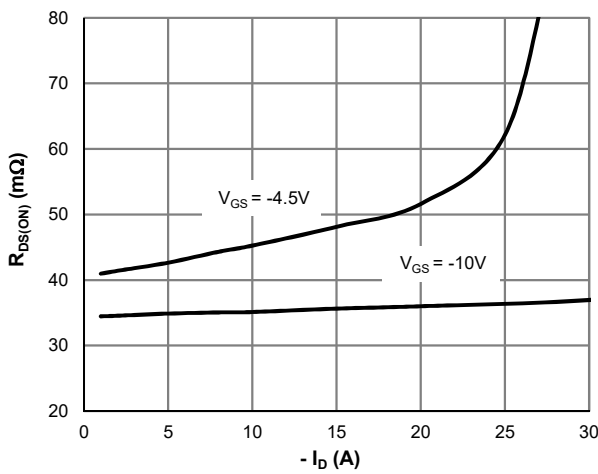
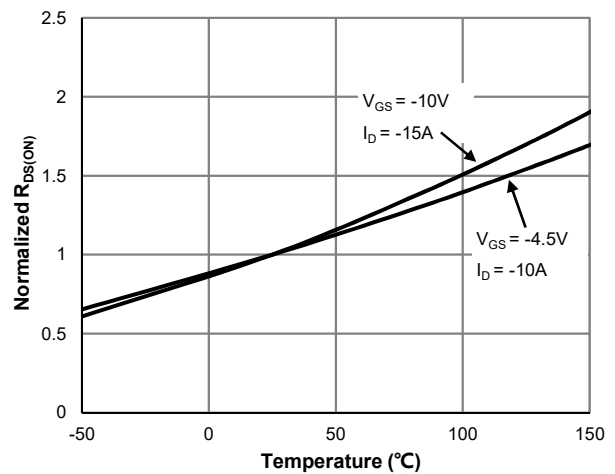
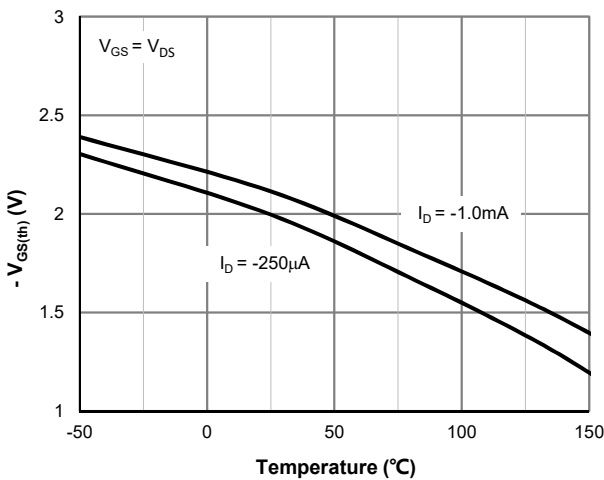
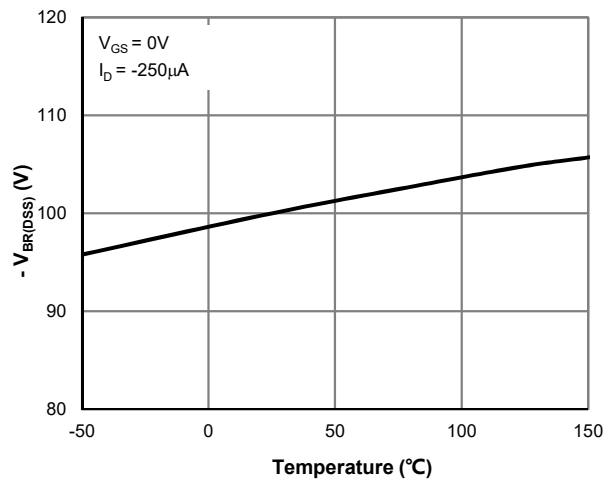
**Typical Electrical & Thermal Characteristics**

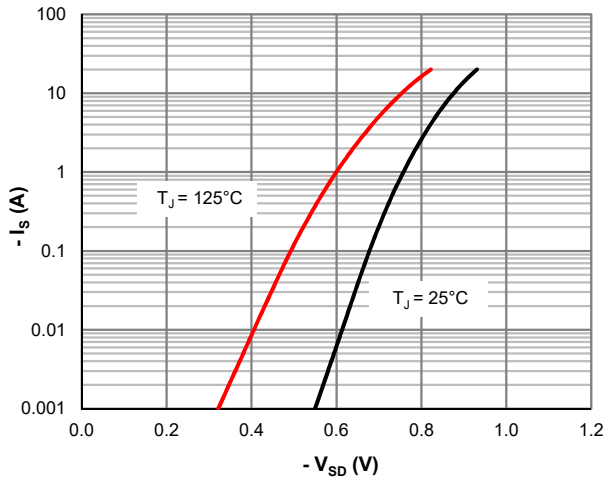
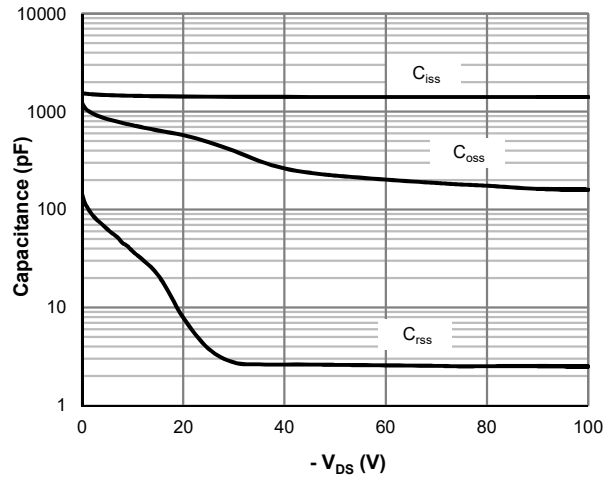
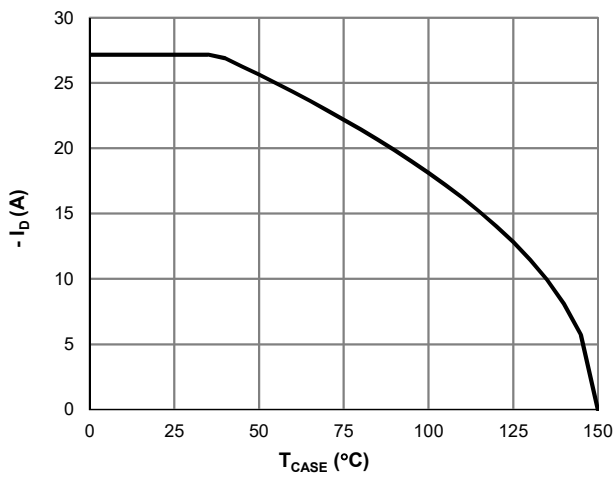
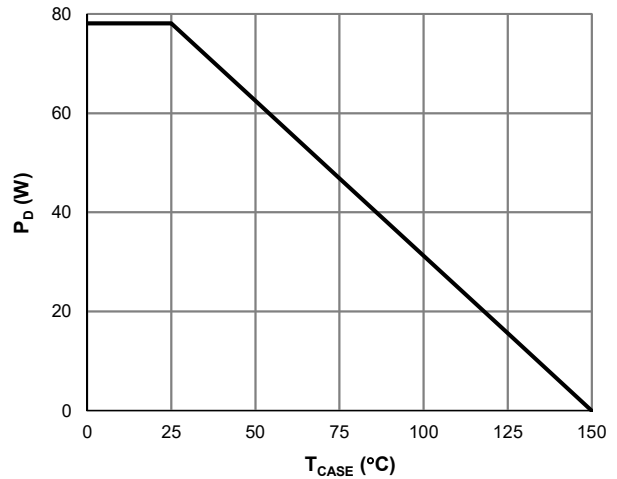
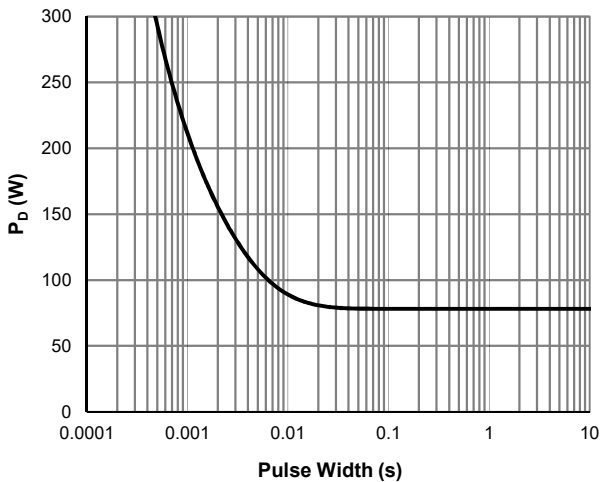
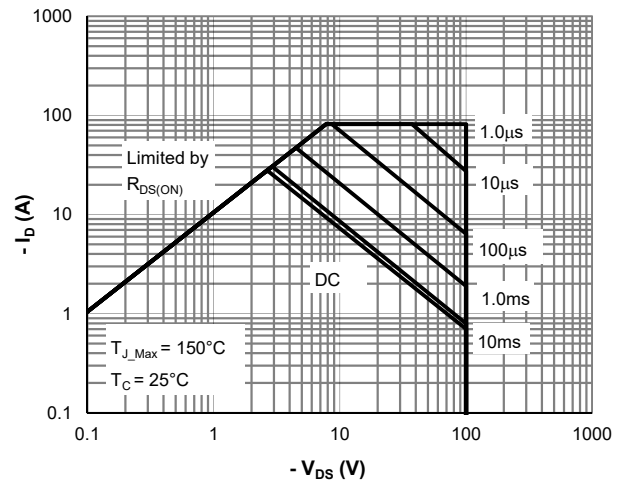
**Figure 1: Saturation Characteristics**

**Figure 2: Transfer Characteristics**

**Figure 3:  $R_{DS(ON)}$  vs. Drain Current**

**Figure 4:  $R_{DS(ON)}$  vs. Junction Temperature**

**Figure 5:  $V_{GS(th)}$  vs. Junction Temperature**

**Figure 6:  $V_{BR(DSS)}$  vs. Junction Temperature**

**Typical Electrical & Thermal Characteristics**

**Figure 7: Body-Diode Characteristics**

**Figure 8: Capacitance Characteristics**

**Figure 9: Current De-rating**

**Figure 10: Power De-rating**

**Figure 11: Single Pulse Power Rating, Junction-to-Case**

**Figure 12: Maximum Safe Operating Area**



Typical Electrical & Thermal Characteristics

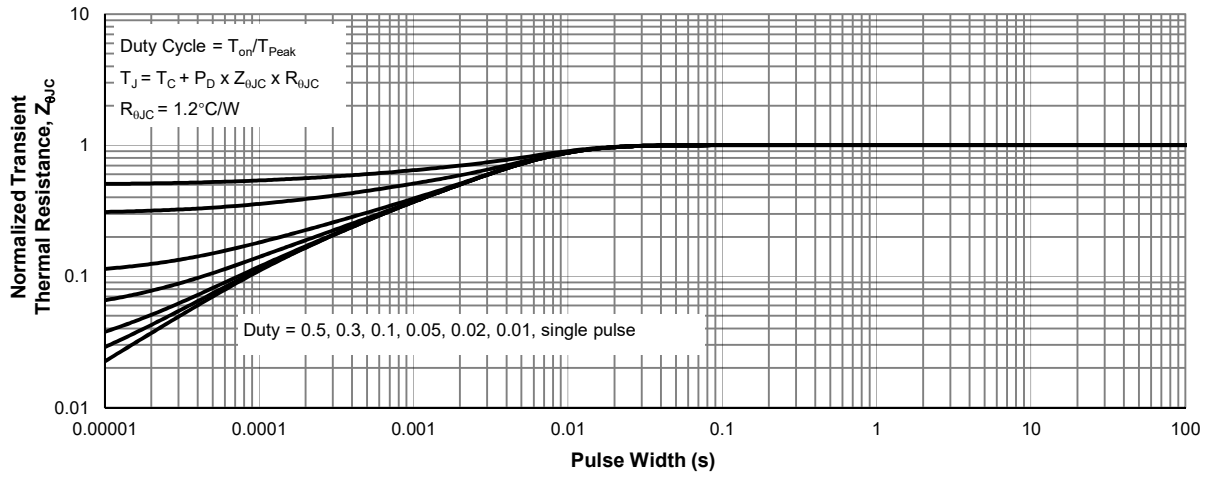
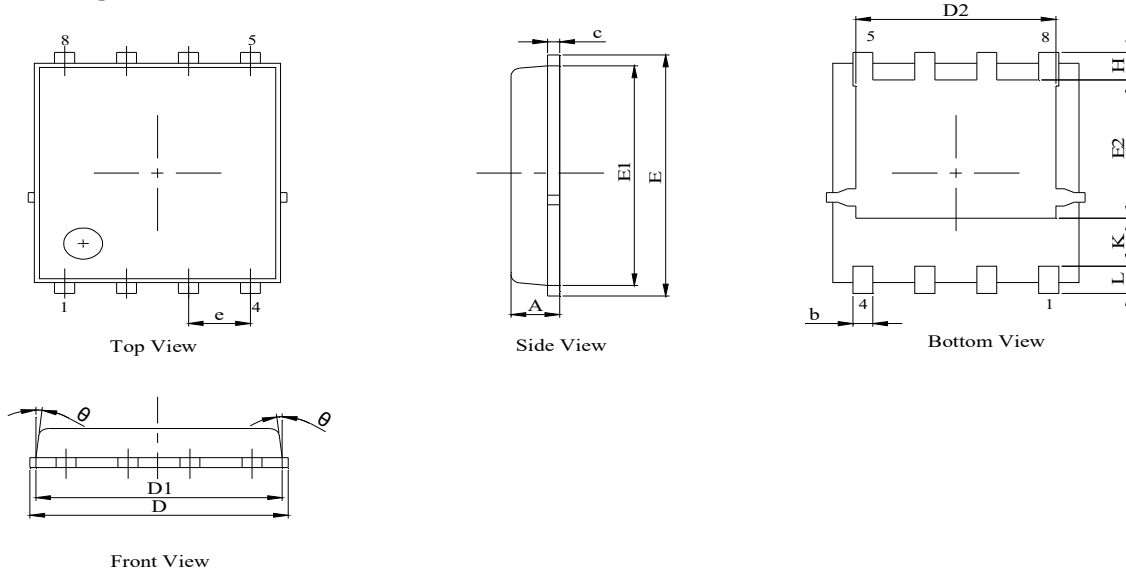
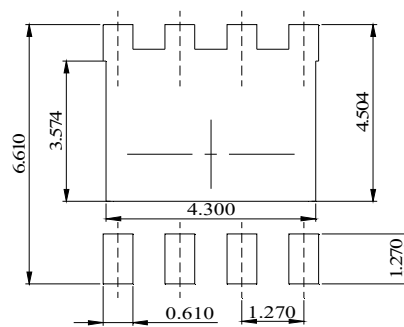

Figure 13: Normalized Maximum Transient Thermal Impedance

**PDFN5x6-8L Package Information**
**Package Outline**

**NOTES:**

1. Dimension and tolerance per ASME Y14.5M, 1994.
2. All dimensions in millimeter (angle in degree).
3. Dimensions D1 and E1 do not include mold flash protrusions or gate burrs.

DIM.	MILLIMETER		
	MIN.	NOM.	MAX.
A	0.90	1.00	1.10
b	0.31	0.41	0.51
c	0.20	0.25	0.30
D	5.00	5.20	5.40
D1	4.95	5.05	5.15
D2	4.00	4.10	4.20
E	6.05	6.15	6.25
E1	5.50	5.60	5.70
E2	3.42	3.53	3.63
e	1.27BSC		
H	0.60	0.70	0.80
L	0.50	0.70	0.80
$\theta$	-	-	10°

**Recommended Soldering Footprint**

DIMENSIONS: MILLIMETERS

单击下面可查看定价，库存，交付和生命周期等信息

[>>JW\(捷捷微\)](#)