



AKS Series 10kA Transient Voltage Suppressor

Rev.2.0

DESCRIPTION:

The AKS series of high current bi-directional transient suppressors are designed for A.C. line protection and high power DC bus clamping applications. They provide a clamping voltage lower than the avalanche voltage. Therefore, any voltage rise due to increased current conduction is contained to a minimum, providing the best possible protection level. They can also be connected in series and/or parallel to create very high capacity protection solutions.

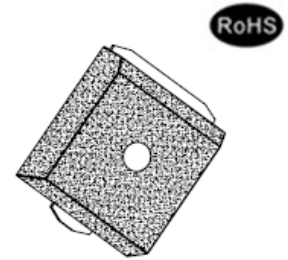

SMT0-218Tab

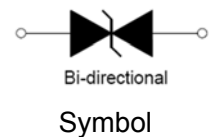

FEATURES:

- ✧ Halogen-free.
- ✧ Bi-directional.
- ✧ Low slope resistance.
- ✧ Very low clamping voltage.
- ✧ Sharp breakdown voltage.
- ✧ RoHS compliant.
- ✧ Glass passivated junction.
- ✧ Meets MSL level 1, per J-STD-020, LF maximum peak of 260°C.
- ✧ Terminal: solder plated, solderable per J-STD-002.
- ✧ High power TVS with compact design in surface mount package.
- ✧ Plastic package has underwriters laboratory flammability 94V-0.
- ✧ Ideal for automatic pick and place assembly and reflow process to reduce the manufacturing cost and increase the soldering quality compared to axial leads package.
- ✧ High temperature reflow soldering: 260°C/40s at terminals.
- ✧ IEC61000-4-2 (ESD) ±30kV (air), ±30kV (contact).

ABSOLUTE MAXIMUM RATINGS (T_A=25°C, RH=45%-75%, unless otherwise noted)

Parameter	Symbol	Value	Unit
Minimum peak pulse current rating per 8/20μs IEC 61000-4-5	I _{PP}	10	kA
Operating junction temperature range	T _J	-55 to +125	°C
Storage temperature range	T _{STG}	-55 to +150	°C
Typical thermal resistance junction to lead	R _{θJL}	10	°C/W
Typical thermal resistance junction to ambient	R _{θJA}	50	°C/W

ELECTRICAL CHARACTERISTICS (T_A=25°C)

Part Number	V _R	V _{BR@I_T}		I _T	I _{R@V_R}	V _{C@I_{PP}^①}	I _{PP} ^①	I _{PP} ^②		C _O
		Min(V)	Max(V)					Min(A)	Typ(A)	
AK10-058CS	58	64	70	10	10	110	10000	800	1000	8.5
AK10-066CS	66	72	80	10	10	120	10000	800	1000	7.5
AK10-076CS	76	85	95	10	10	140	10000	1400	1700	6.5
AK10-086CS	86	95	105	10	10	157	10000	1400	1700	6.5

① Surge waveform: 8/20μs

② Surge waveform: 10/350μs

V_R: Stand-off voltage -- Maximum voltage that can be applied

V_{BR}: Breakdown voltage

V_C: Clamping voltage -- Peak voltage measured across the suppressor at a specified I_{PP}

I_R: Reverse leakage current

RATINGS AND V-I CHARACTERISTICS CURVES (T_A=25°C, unless otherwise noted)

FIG.1: V- I curve characteristics (Bi-directional with negative resistance)

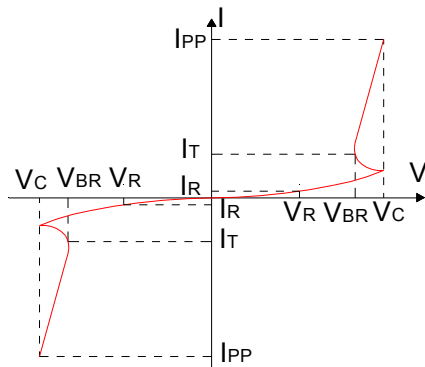

FIG.2: Typical V_{BR} vs. junction temperature

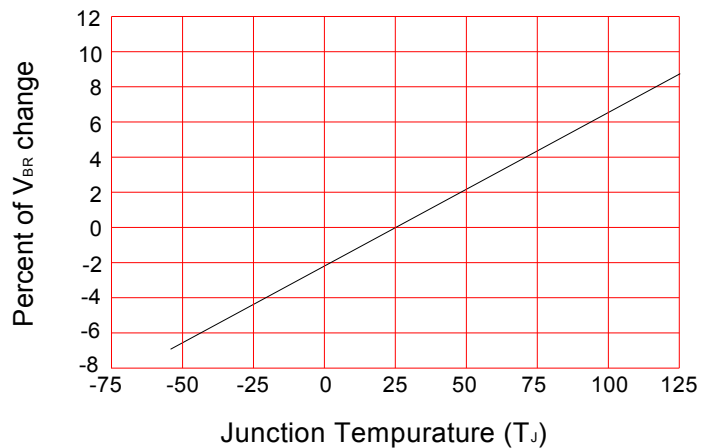

FIG.3: Pulse waveform

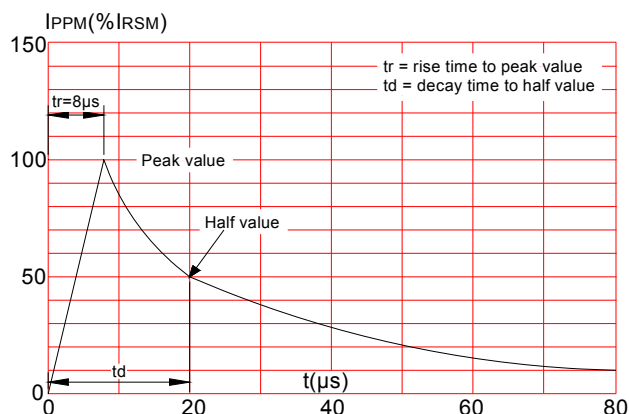

FIG.4: Pulse waveform

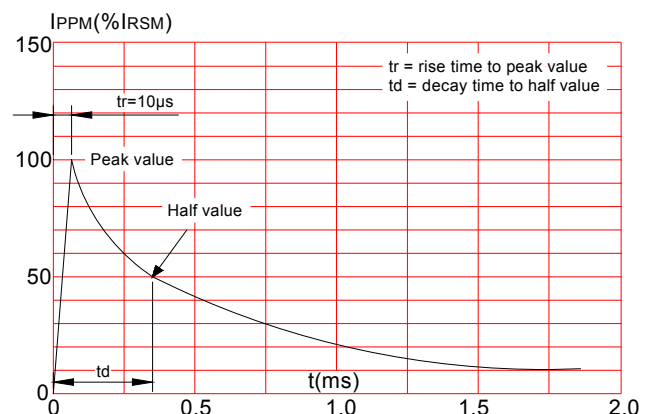

FIG.5: Pulse derating curve(8/20μs)

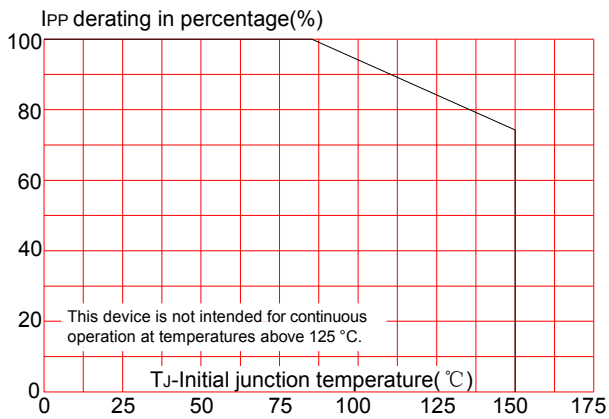
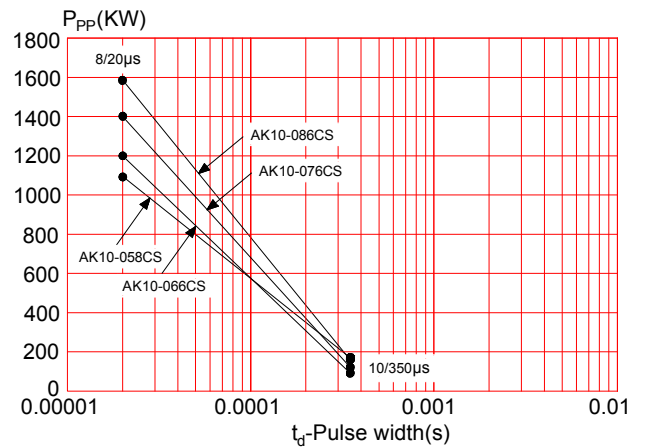
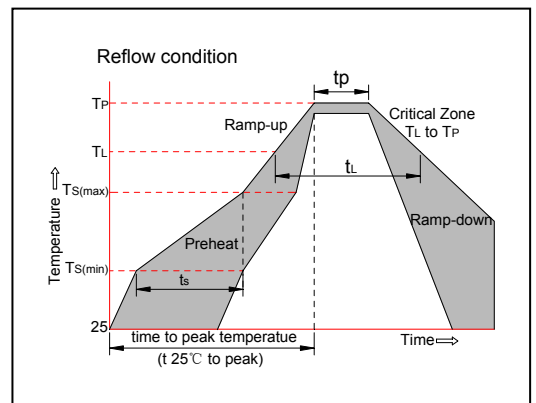

FIG.6: Peak pulse power dissipation vs. pulse width



SOLDERING PARAMETERS

Reflow Condition		Pb-Free assembly (see figure at right)
Pre Heat	-Temperature Min ($T_{s(min)}$)	+150°C
	-Temperature Max($T_{s(max)}$)	+200°C
	-Time (Min to Max) (t_s)	60-180 secs.
Average ramp up rate (Liquidus Temp (T_L) to peak)		3°C/sec. Max
$T_{s(max)}$ to T_L - Ramp-up Rate		3°C/sec. Max
Reflow	-Temperature(T_L)(Liquidus)	+217°C
	-Temperature(t_L)	60-150 secs.
Peak Temp (T_p)		+260(+0/-5)°C
Time within 5°C of actual Peak Temp (t_p)		20-40secs.
Ramp-down Rate		6°C/sec. Max
Time 25°C to Peak Temp (T_p)		8 min. Max
Do not exceed		+260°C



PACKAGE MECHANICAL DATA

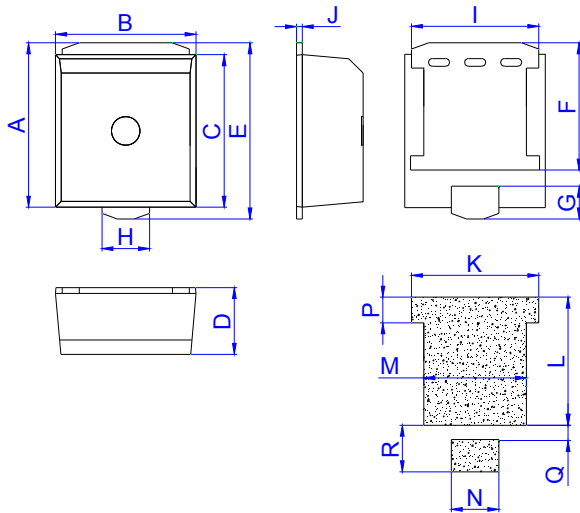

SMTO-218Tab

Ref.	Dimensions					
	Millimeters			Inches		
	Min.	Typ.	Max.	Min.	Typ.	Max.
A	17.00		17.60	0.669		0.693
B	14.50		15.10	0.571		0.594
C	15.75		16.35	0.620		0.644
D	6.85		7.20	0.270		0.283
E	18.20		18.70	0.717		0.736
F	13.10		13.60	0.516		0.535
G	3.15		3.75	0.124		0.148
H	4.85		5.15	0.191		0.203
I	13.20		13.60	0.520		0.535
J	0.50		0.70	0.020		0.028
K		13.70			0.539	
L		13.45			0.530	
M		10.80			0.425	
N		5.30			0.209	
P		3.00			0.118	
Q		1.50			0.059	
R		4.90			0.193	

TAPE AND REEL SPECIFICATION-SMTO-218Tab

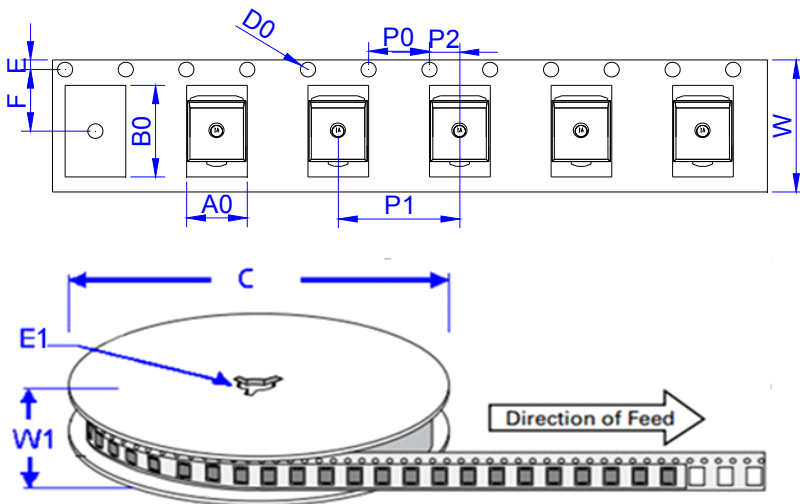

Ref.	Dimensions	
	Millimeters	Inches
A0	15.1 ± 0.3	0.594± 0.012
B0	18.8 ± 0.3	0.740 ± 0.012
C	330	13
D0	1.50 ± 0.1	0.059 ± 0.004
E	1.75 ± 0.2	0.069 ± 0.008
E1	13.30 ± 0.3	0.524± 0.012
F	14.20 ± 0.2	0.559 ± 0.008
P0	4.0 ± 0.2	0.157 ± 0.008
P1	20.0 ± 0.2	0.787 ± 0.008
P2	2.0 ± 0.2	0.079 ± 0.008
W	32.0± 0.2	1.260 ± 0.008
W1	36.0±0.5	1.417±0.020

PART No.	UNIT WEIGHT (g/PCS) typ.	REEL (PCS)	PER CARTON (PCS)	DESCRIPTION
AK10-xxxCS	6.48	400	1,600	13 inch reel pack

MARKING & ORDERING INFORMATION

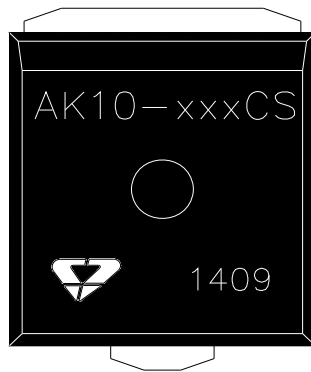

AK 10 - xxx C S
(1) (2) (3) (4) (5)

- (1)AK series
- (2)I_{PP}=10kA
- (3)Reverse stand-off voltage
- (4)Bi-directional
- (5)Package:SMTO-218Tab

1409:In ninth week,2014

Information furnished in this document is believed to be accurate and reliable. However, Jiangsu JieJie Microelectronics Co.,Ltd assumes no responsibility for the consequences of use without consideration for such information nor use beyond it.

Information mentioned in this document is subject to change without notice, apart from that when an agreement is signed, Jiangsu JieJie complies with the agreement.

Products and information provided in this document have no infringement of patents. Jiangsu JieJie assumes no responsibility for any infringement of other rights of third parties which may result from the use of such products and information.

This document is the second version which is made in 13-Jan.-2022. This document supersedes and replaces all information previously supplied.

 is a registered trademark of Jiangsu JieJie Microelectronics Co.,Ltd.

Copyright©2022 Jiangsu JieJie Microelectronics Co.,Ltd. Printed All rights reserved.

单击下面可查看定价，库存，交付和生命周期等信息

[>>JW\(捷捷微\)](#)