



P6KE Series 600W Transient Voltage Suppressor

Rev.3.3

DESCRIPTION

The P6KE series of high current transient suppressors are designed for A.C. line protection and high power DC bus clamping applications. These devices offer uni/bi-directional port protection from 6.8 volts to 600 volts. They provide a clamping voltage lower than the avalanche voltage. Therefore, any voltage rise due to increased current conduction is contained to a minimum, providing the best possible protection level. They can also be connected in series and/or parallel to create very high capacity protection solutions.

FEATURES

- ✧ Low incremental surge resistance.
- ✧ Excellent clamping capability.
- ✧ Color band denoted cathode except bidirectional.
- ✧ Typical I_R less than $1\mu A$ above 11V.
- ✧ High temperature wave soldering: $265^\circ C/10s$ at terminals.
- ✧ Plastic package has underwriters laboratory flammability 94V-0.
- ✧ 600W peak pulse power capability at 10/1000 μs waveform.
- ✧ Meets MSL level 1, per J-STD-020, LF maximum peak of $260^\circ C$.
- ✧ Terminal: solder plated, solderable per J-STD-002.
- ✧ Fast response time: typically less than 1.0ps from 0V to V_{BR} min.
- ✧ UL 497B item recognized. (File No.:E480698).
- ✧ IEC61000-4-2 (ESD) $\pm 30kV$ (air), $\pm 30kV$ (contact).

ABSOLUTE MAXIMUM RATINGS ($T_A=25^\circ C$, RH=45%-75%, unless otherwise noted)

Parameter	Symbol	Value	Unit
Operating junction and storage temperature range	T_J, T_{STG}	-55 to +175	$^\circ C$
Steady state power dissipation at $T_L=75^\circ C$	$P_{M(AV)}$	5.0	W
Peak pulse power dissipation at 10/1000 μs waveform	P_{PP}	600	W
Maximum instantaneous forward voltage at 50A for unidirectional	V_F	5.0	V
Peak forward surge current, 8.3ms single half sine-wave for unidirectional only (NOTE 1)	I_{FSM}	100	A

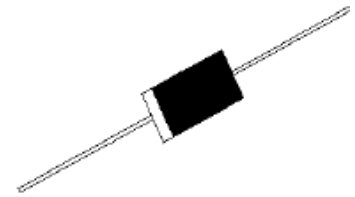

DO-15



Bi-directional



Uni-directional

Symbol

ABSOLUTE MAXIMUM RATINGS ($T_A=25^{\circ}\text{C}$, RH=45%-75%, unless otherwise noted, continued)

Parameter	Symbol	Value	Unit
Typical thermal resistance junction to lead	$R_{\theta JL}$	20	$^{\circ}\text{C}/\text{W}$
Typical thermal resistance junction to ambient	$R_{\theta JA}$	75	$^{\circ}\text{C}/\text{W}$

Notes:

1. Measured on 8.3ms single half sine wave or equivalent square wave for unidirectional device only, duty cycle=4 per minute maximum

ELECTRICAL CHARACTERISTICS ($T_A=25^{\circ}\text{C}$)

Part Number		V_R	$I_R@V_R$	$V_{BR}@I_T$		I_T	$V_C@I_{PP}$	$I_{PP}^{\text{①}}$
Uni-Polar	Bi-Polar	V	max(μA)	min(V)	max(V)	mA	max(V)	A
P6KE6.8A	P6KE6.8CA	5.8	150	6.45	7.14	10	10.5	58.1
P6KE7.5A	P6KE7.5CA	6.4	120	7.13	7.88	10	11.3	54.0
P6KE8.2A	P6KE8.2CA	7.02	50	7.79	8.61	10	12.1	50.4
P6KE9.1A	P6KE9.1CA	7.78	20	8.65	9.55	1	13.4	45.5
P6KE10A	P6KE10CA	8.55	10	9.50	10.50	1	14.5	42.1
P6KE11A	P6KE11CA	9.4	5	10.50	11.60	1	15.6	39.1
P6KE12A	P6KE12CA	10.2	2	11.40	12.60	1	16.7	36.5
P6KE13A	P6KE13CA	11.1	1	12.40	13.70	1	18.2	33.5
P6KE15A	P6KE15CA	12.8	1	14.30	15.80	1	21.2	28.8
P6KE16A	P6KE16CA	13.6	1	15.20	16.80	1	22.5	27.1
P6KE18A	P6KE18CA	15.3	1	17.10	18.90	1	25.2	24.2
P6KE20A	P6KE20CA	17.1	1	19.00	21.00	1	27.7	22.0
P6KE22A	P6KE22CA	18.8	1	20.90	23.10	1	30.6	19.9
P6KE24A	P6KE24CA	20.5	1	22.80	25.20	1	33.2	18.4
P6KE27A	P6KE27CA	23.1	1	25.70	28.40	1	37.5	16.3
P6KE30A	P6KE30CA	25.6	1	28.50	31.50	1	41.4	14.7
P6KE33A	P6KE33CA	28.2	1	31.40	34.70	1	45.7	13.3
P6KE36A	P6KE36CA	30.8	1	34.20	37.80	1	49.9	12.2
P6KE39A	P6KE39CA	33.3	1	37.10	41.00	1	53.9	11.3
P6KE43A	P6KE43CA	36.8	1	40.90	45.20	1	59.3	10.3
P6KE47A	P6KE47CA	40.2	1	44.70	49.40	1	64.8	9.4
P6KE51A	P6KE51CA	43.6	1	48.50	53.60	1	70.1	8.7

ELECTRICAL CHARACTERISTICS (T_A=25°C, continued)

Part Number		V _R	I _{R@V_R}	V _{BR@I_T}		I _T	V _{C@I_{PP}}	I _{PP} ^①
Uni-Polar	Bi-Polar	V	max(μA)	min(V)	max(V)	mA	max(V)	A
P6KE56A	P6KE56CA	47.8	1	53.20	58.80	1	77.0	7.9
P6KE62A	P6KE62CA	53.0	1	58.90	65.10	1	85.0	7.9
P6KE68A	P6KE68CA	58.1	1	64.60	71.40	1	92.0	6.6
P6KE75A	P6KE75CA	64.1	1	71.30	78.80	1	103.0	5.9
P6KE82A	P6KE82CA	70.1	1	77.90	86.10	1	113.0	5.4
P6KE91A	P6KE91CA	77.8	1	86.50	95.50	1	125.0	4.9
P6KE100A	P6KE100CA	85.5	1	95.00	105.0	1	137.0	4.5
P6KE110A	P6KE110CA	94.0	1	105.0	116.0	1	152.0	4.0
P6KE120A	P6KE120CA	102.0	1	114.0	126.0	1	165.0	3.7
P6KE130A	P6KE130CA	111.0	1	124.0	137.0	1	179.0	3.4
P6KE150A	P6KE150CA	128.0	1	143.0	158.0	1	207.0	2.9
P6KE160A	P6KE160CA	136.0	1	152.0	168.0	1	219.0	2.8
P6KE170A	P6KE170CA	145.0	1	162.0	179.0	1	234.0	2.6
P6KE180A	P6KE180CA	154.0	1	171.0	189.0	1	246.0	2.5
P6KE200A	P6KE200CA	171.0	1	190.0	210.0	1	274.0	2.2
P6KE220A	P6KE220CA	185.0	1	209.0	231.0	1	328.0	1.9
P6KE250A	P6KE250CA	214.0	1	237.0	263.0	1	344.0	1.8
P6KE300A	P6KE300CA	256.0	1	285.0	315.0	1	414.0	1.5
P6KE350A	P6KE350CA	300.0	1	332.0	368.0	1	482.0	1.3
P6KE400A	P6KE400CA	342.0	1	380.0	420.0	1	548.0	1.1
P6KE440A	P6KE440CA	376.0	1	418.0	462.0	1	602.0	1.0
P6KE480A	P6KE480CA	408.0	1	456.0	504.0	1	658.0	0.9
P6KE510A	P6KE510CA	434.0	1	485.0	535.0	1	698.0	0.9
P6KE540A	P6KE540CA	460.0	1	513.0	567.0	1	740.0	0.8
P6KE550A	P6KE550CA	468.0	1	522.5	577.5	1	760.0	0.8
P6KE600A	P6KE600CA	512.0	1	570.0	630.0	1	828.0	0.75

① Surge waveform: 10/1000μs

V_R: Stand-off voltage -- Maximum voltage that can be appliedV_{BR}: Breakdown voltageV_C: Clamping voltage -- Peak voltage measured across the suppressor at a specified I_{PP}I_R: Reverse leakage current

RATINGS AND V-I CHARACTERISTICS CURVES ($T_A=25^{\circ}\text{C}$, unless otherwise noted)

FIG.1: V- I curve characteristics (Uni-directional)

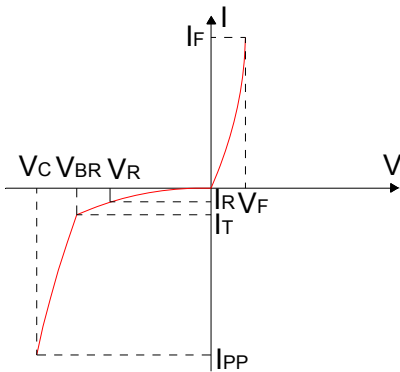

FIG.2: V- I curve characteristics (Bi-directional)

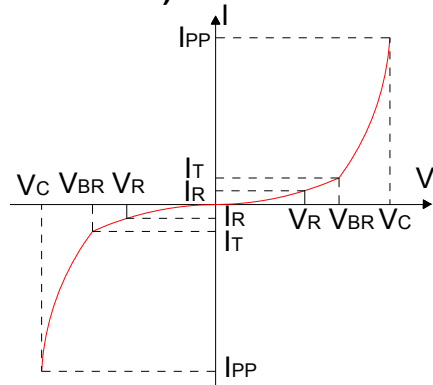

FIG.3: Pulse waveform

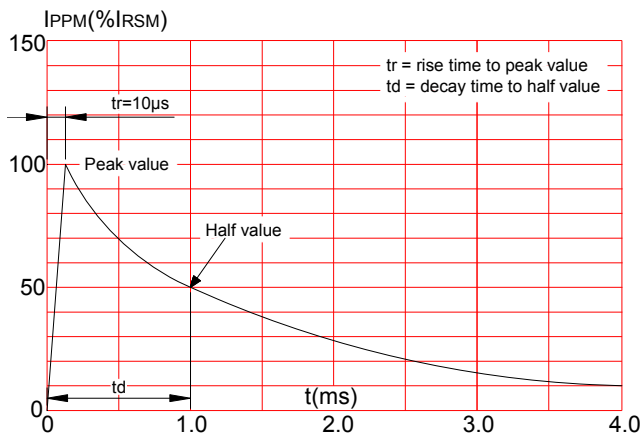
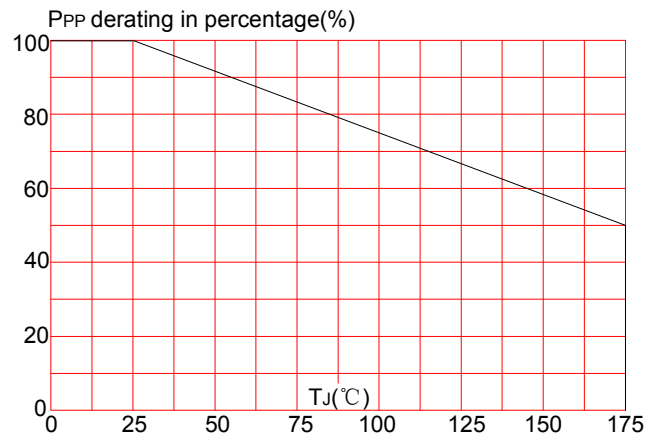
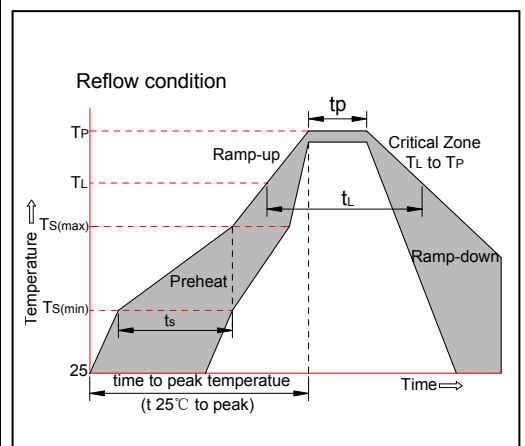

FIG.4: Pulse derating curve



SOLDERING PARAMETERS

Reflow Condition		Pb-Free assembly (see figure at right)
Pre Heat	-Temperature Min ($T_{s(min)}$)	+150°C
	-Temperature Max($T_{s(max)}$)	+200°C
	-Time (Min to Max) (t_s)	60-180 secs.
Average ramp up rate (Liquidus Temp (T_L) to peak)		3°C/sec. Max
$T_{s(max)}$ to T_L - Ramp-up Rate		3°C/sec. Max
Reflow	-Temperature(T_L)(Liquidus)	+217°C
	-Temperature(T_L)	60-150 secs.
Peak Temp (T_p)		+260(+0/-5)°C
Time within 5°C of actual Peak Temp (t_p)		20-40secs.
Ramp-down Rate		6°C/sec. Max
Time 25°C to Peak Temp (T_p)		8 min. Max
Do not exceed		+260°C



Flow/Wave Soldering(Solder Dipping)	
Peak temperature	265°C
Dipping time	10 sec.
Soldering	1 time

MARKING & ORDERING INFORMATION

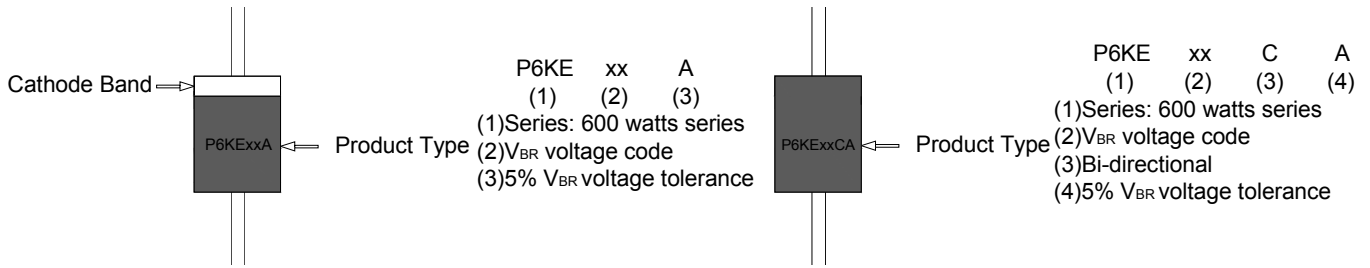

PACKAGE MECHANICAL DATA

Ref.	Dimensions			
	Millimeters		Inches	
	Min.	Max.	Min.	Max.
A	25.40	-	1.000	-
B	5.80	7.62	0.228	0.300
C	0.71	0.86	0.028	0.034
D	2.60	3.60	0.102	0.142

TAPE AND BOX SPECIFICATION-DO-15

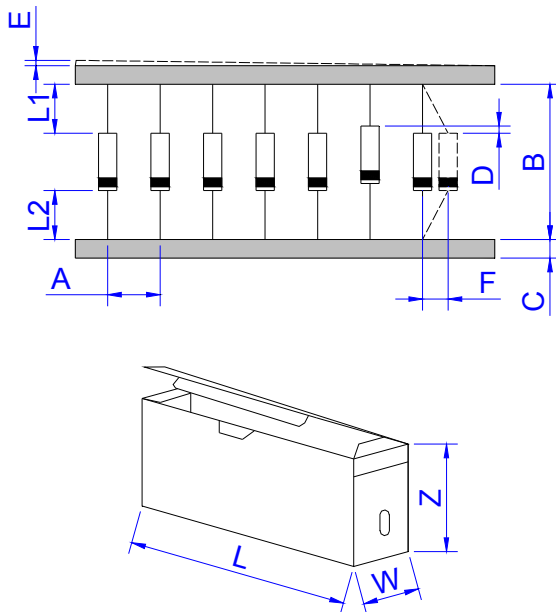

Ref.	Dimensions	
	Millimeters	Inches
A	5.0±0.5	0.197±0.020
B	53.0±1.5	2.087±0.059
C	6.0±0.5	0.236±0.020
D	1.2(MAX)	0.047(MAX)
E	0.8(MAX)	0.031(MAX)
F	1.5(MAX)	0.059(MAX)
L1-L2	1.0(MAX)	0.039(MAX)
W	80±5.0	3.150±0.197
L	250±5.0	9.843±0.197
Z	115±5.0	4.528±0.197

PART No.	UNIT WEIGHT (g/PCS) typ.	PER BOX (PCS)	PER CARTON (PCS)	DESCRIPTION
P6KExxA/CA	0.42	2,000	20,000	Box

Information furnished in this document is believed to be accurate and reliable. However, Jiangsu JieJie Microelectronics Co.,Ltd assumes no responsibility for the consequences of use without consideration for such information nor use beyond it.

Information mentioned in this document is subject to change without notice, apart from that when an agreement is signed, Jiangsu JieJie complies with the agreement.

Products and information provided in this document have no infringement of patents. Jiangsu JieJie assumes no responsibility for any infringement of other rights of third parties which may result from the use of such products and information.

This document is the 3.3rd version which is made in 2-Aug.-2021. This document supersedes and replaces all information previously supplied.

 is a registered trademark of Jiangsu JieJie Microelectronics Co.,Ltd.

Copyright©2021 Jiangsu JieJie Microelectronics Co.,Ltd. Printed All rights reserved.

单击下面可查看定价，库存，交付和生命周期等信息

[>>JW\(捷捷微\)](#)