



150V 14.5mΩ N-Ch Power MOSFET

Features

- Ultra-low $R_{DS(ON)}$
- Low Gate Charge
- 100% UIS Tested, 100% R_g Tested
- Pb-free Lead Plating
- Halogen-free and RoHS-compliant

Product Summary

Parameter	Value	Unit
V_{DS}	150	V
$V_{GS(th)}_{Typ}$	3.2	V
I_D (@ $V_{GS} = 10V$) ⁽¹⁾	61	A
$R_{DS(ON)}_{Typ}$ (@ $V_{GS} = 10V$)	14.5	mΩ

Applications

- Power Management in Telecom., Industrial Automation, CE
- Current Switching in DC/DC & AC/DC (SR) Sub-systems
- Motor Driving in Power Tool, E-vehicle, Robotics

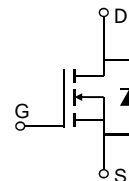
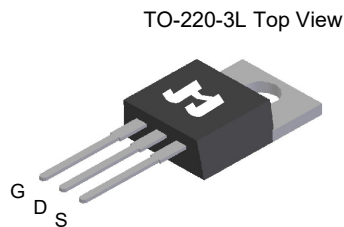

Ordering Information

Device	Package	# of Pins	Marking	MSL	T_J (°C)	Media	Quantity (pcs)
JMSH1516AC-U	TO-220-3L	3	SH1516A	NA	-55 to 150	Tube	50
JMSH1516AE-13	TO-263-3L	3	SH1516A	1	-55 to 150	13-inch Reel	800

Absolute Maximum Ratings (@ $T_A = 25^\circ C$ unless otherwise specified)

Parameter	Symbol	Value	Unit
Drain-to-Source Voltage	V_{DS}	150	V
Gate-to-Source Voltage	V_{GS}	±20	V
Continuous Drain Current ⁽¹⁾	I_D	$T_C = 25^\circ C$	61
		$T_C = 100^\circ C$	38
Pulsed Drain Current ⁽²⁾	I_{DM}	200	A
Avalanche Current ⁽³⁾	I_{AS}	30	A
Avalanche Energy ⁽³⁾	E_{AS}	135	mJ
Power Dissipation ⁽⁴⁾	P_D	$T_C = 25^\circ C$	139
		$T_C = 100^\circ C$	56
Junction & Storage Temperature Range	T_J, T_{STG}	-55 to 150	°C

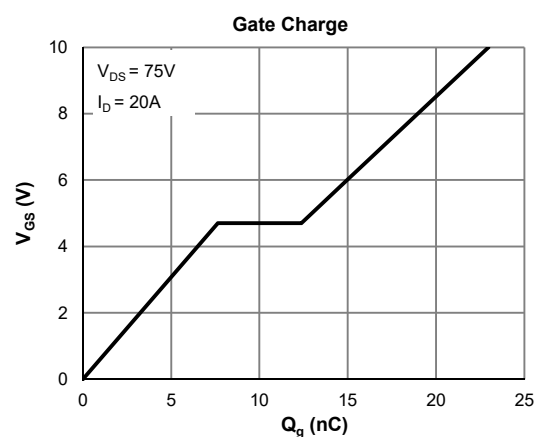
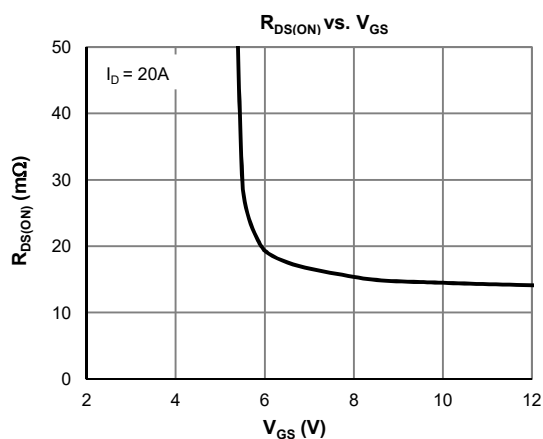



Electrical Characteristics (@ $T_J = 25^\circ\text{C}$ unless otherwise specified)

Parameter	Symbol	Conditions	Min.	Typ.	Max.	Unit
STATIC PARAMETERS						
Drain-Source Breakdown Voltage	$V_{(BR)DSS}$	$I_D = 250\mu\text{A}, V_{GS} = 0\text{V}$	150			V
Zero Gate Voltage Drain Current	I_{DSS}	$V_{DS} = 120\text{V}, V_{GS} = 0\text{V}$			1.0	μA
					5.0	
Gate-Body Leakage Current	I_{GSS}	$V_{DS} = 0\text{V}, V_{GS} = \pm 20\text{V}$			± 100	nA
Gate Threshold Voltage	$V_{GS(th)}$	$V_{DS} = V_{GS}, I_D = 250\mu\text{A}$	2.5	3.2	4.5	V
Static Drain-Source ON-Resistance	$R_{DS(ON)}$	$V_{GS} = 10\text{V}, I_D = 20\text{A}$		14.5	16.9	m Ω
Forward Transconductance	g_{FS}	$V_{DS} = 5\text{V}, I_D = 20\text{A}$		58		S
Diode Forward Voltage	V_{SD}	$I_S = 1\text{A}, V_{GS} = 0\text{V}$		0.69	1.0	V
Diode Continuous Current	I_S	$T_C = 25^\circ\text{C}$			139	A
DYNAMIC PARAMETERS ⁽⁵⁾						
Input Capacitance	C_{iss}	$V_{GS} = 0\text{V}, V_{DS} = 75\text{V}, f = 1\text{MHz}$		1603		pF
Output Capacitance	C_{oss}			196		pF
Reverse Transfer Capacitance	C_{rss}			7.5		pF
Gate Resistance	R_g	$V_{GS} = 0\text{V}, V_{DS} = 0\text{V}, f = 1\text{MHz}$		1.8		Ω
SWITCHING PARAMETERS ⁽⁵⁾						
Total Gate Charge (@ $V_{GS} = 10\text{V}$)	Q_g	$V_{GS} = 0 \text{ to } 10\text{V}$ $V_{DS} = 75\text{V}, I_D = 20\text{A}$		23		nC
Total Gate Charge (@ $V_{GS} = 6.0\text{V}$)	Q_g			15.2		nC
Gate Source Charge	Q_{gs}			7.7		nC
Gate Drain Charge	Q_{gd}			4.7		nC
Turn-On DelayTime	$t_{D(on)}$	$V_{GS} = 10\text{V}, V_{DS} = 75\text{V}$ $R_L = 3.75\Omega, R_{GEN} = 6\Omega$		7.1		ns
Turn-On Rise Time	t_r			8.4		ns
Turn-Off DelayTime	$t_{D(off)}$			17		ns
Turn-Off Fall Time	t_f			11		ns
Body Diode Reverse Recovery Time	t_{rr}		$I_F = 20\text{A}, dI_F/dt = 100\text{A}/\mu\text{S}$		86	
Body Diode Reverse Recovery Charge	Q_{rr}	$I_F = 20\text{A}, dI_F/dt = 100\text{A}/\mu\text{S}$		137		nC

Thermal Performance

Parameter	Symbol	Typ.	Max.	Unit
Thermal Resistance, Junction-to-Ambient	$R_{\theta JA}$	45	55	$^\circ\text{C}/\text{W}$
Thermal Resistance, Junction-to-Case	$R_{\theta JC}$	0.7	0.9	$^\circ\text{C}/\text{W}$

Notes:

1. Computed continuous current assumes the condition of T_{J_Max} while the actual continuous current depends on the thermal & electro-mechanical application board design.
2. This single-pulse measurement was taken under $T_{J_Max} = 150^\circ\text{C}$.
3. This single-pulse measurement was taken under the following condition [$L = 300\mu\text{H}, V_{GS} = 10\text{V}, V_{DS} = 100\text{V}$] while its value is limited by $T_{J_Max} = 150^\circ\text{C}$.
4. The power dissipation P_D is based on $T_{J_Max} = 150^\circ\text{C}$.
5. This value is guaranteed by design hence it is not included in the production test.

Typical Electrical & Thermal Characteristics

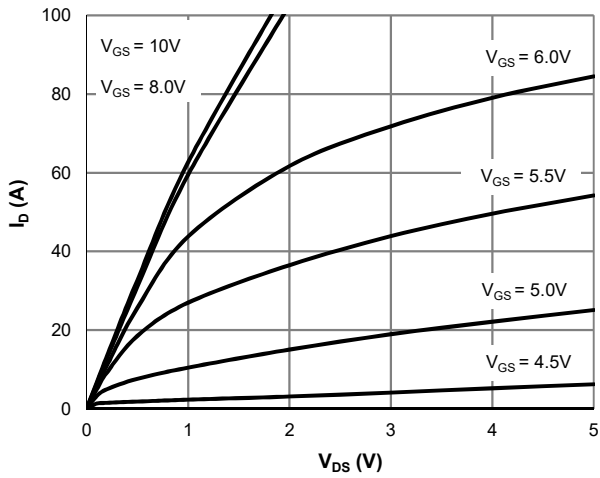

Figure 1: Saturation Characteristics

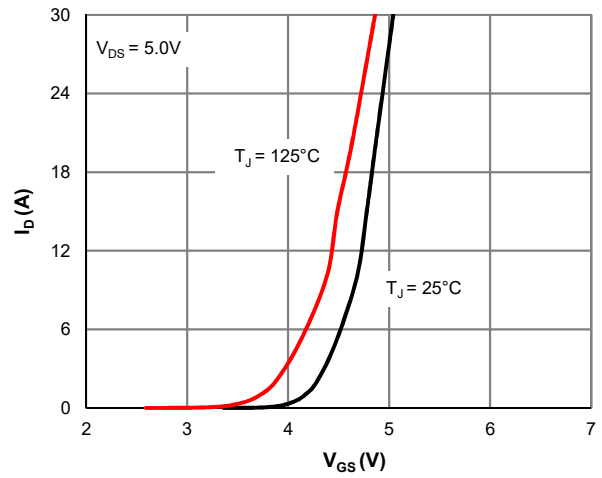

Figure 2: Transfer Characteristics

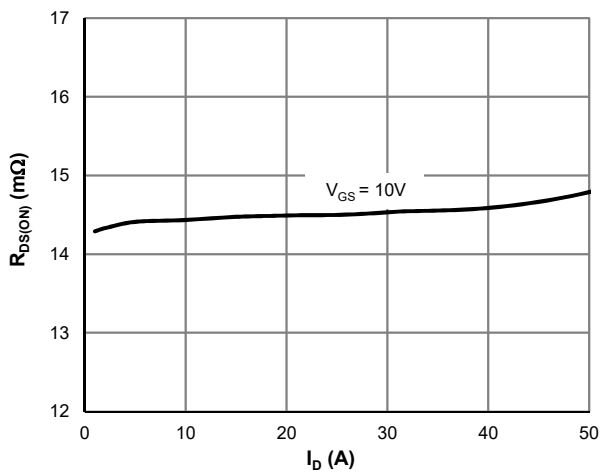

Figure 3: $R_{DS(ON)}$ vs. Drain Current

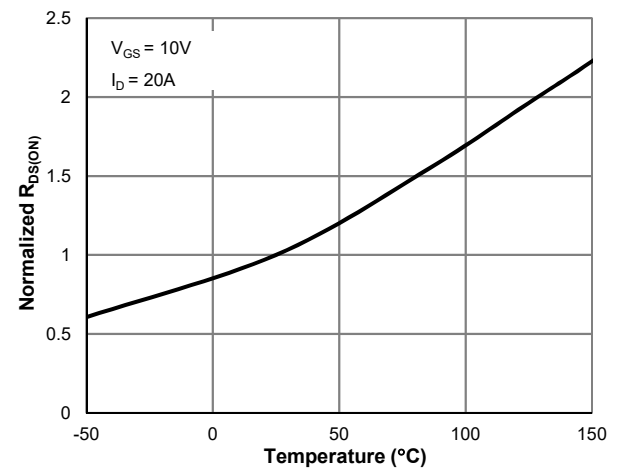

Figure 4: $R_{DS(ON)}$ vs. Junction Temperature

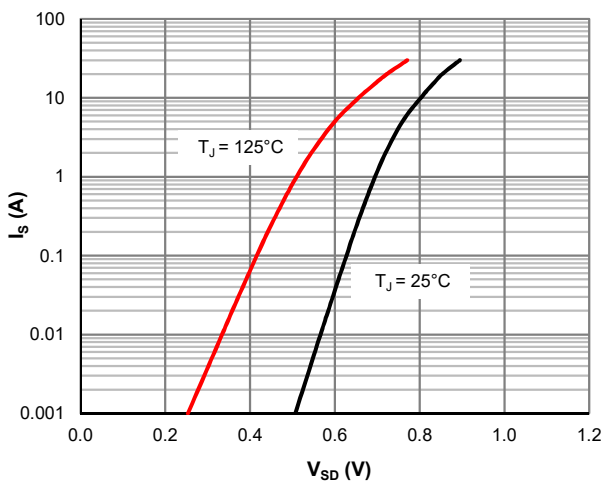

Figure 5: Body-Diode Characteristics

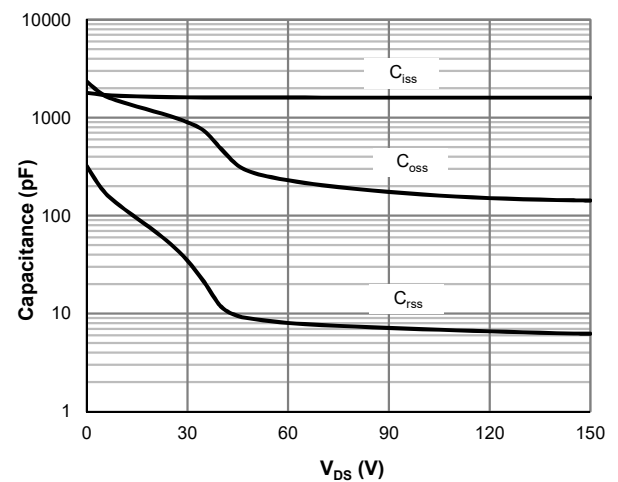

Figure 6: Capacitance Characteristics

Typical Electrical & Thermal Characteristics

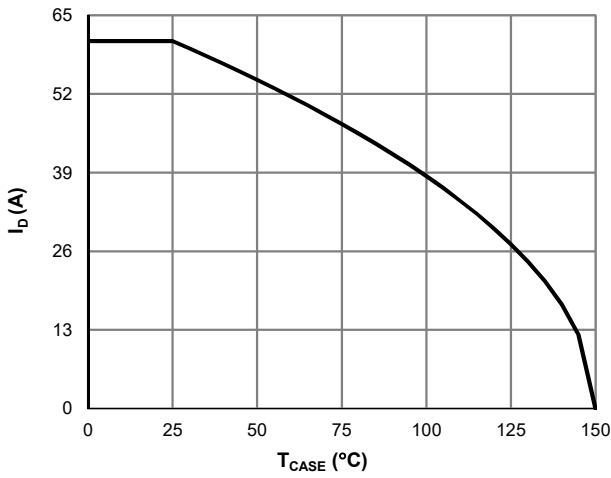

Figure 7: Current De-rating

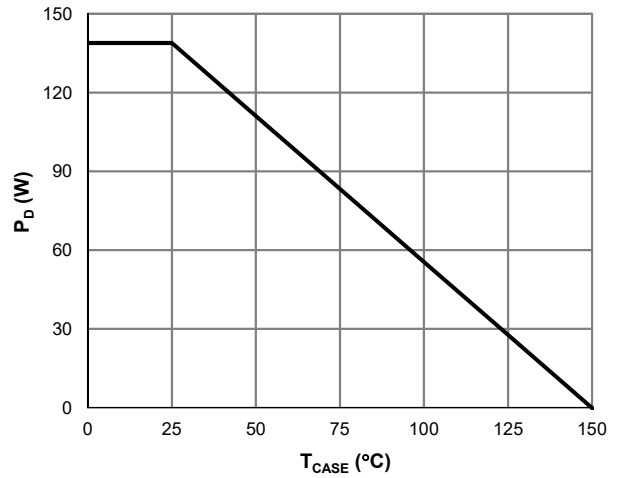

Figure 8: Power De-rating

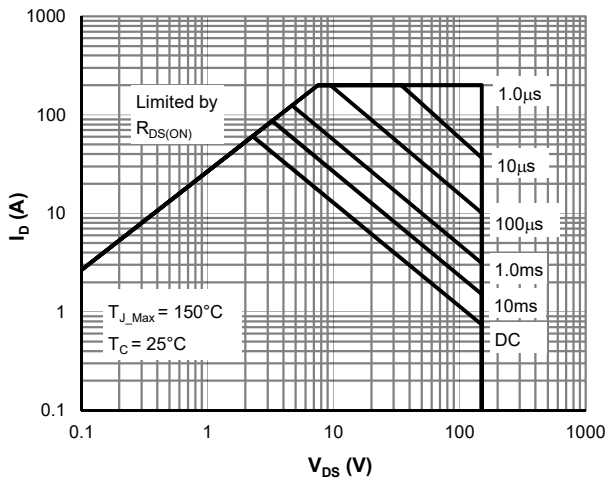

Figure 9: Maximum Safe Operating Area

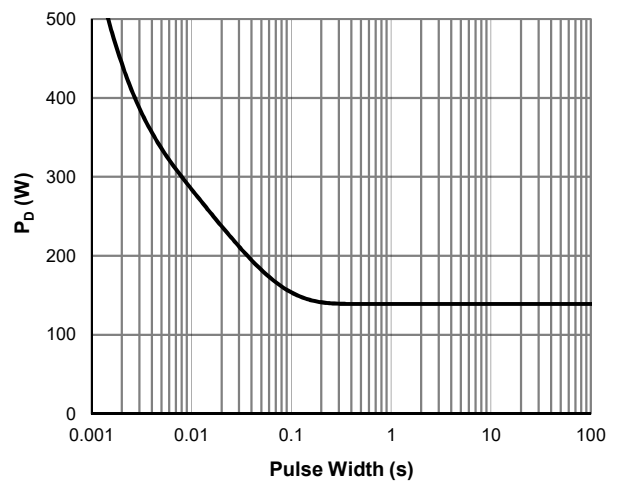

Figure 10: Single Pulse Power Rating, Junction-to-Case

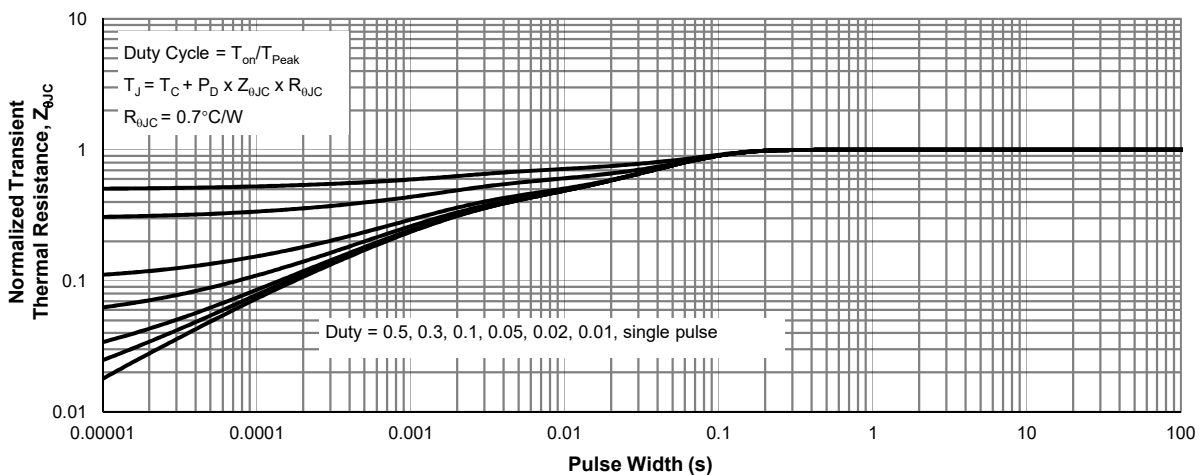
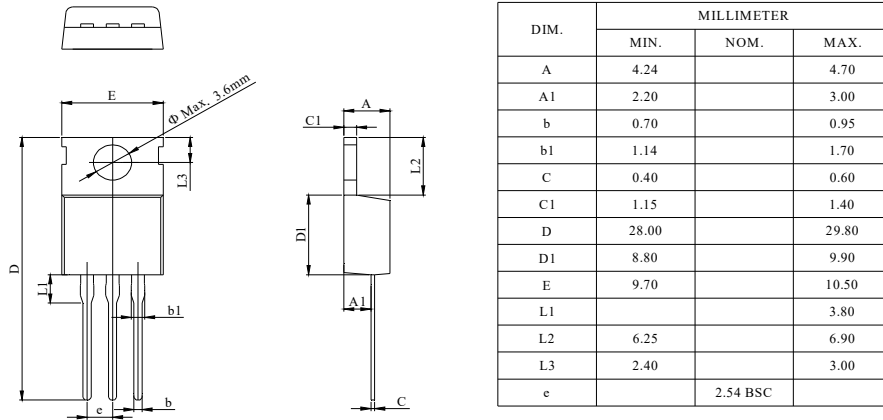

Figure 11: Normalized Maximum Transient Thermal Impedance

TO-220-3L Package Information

Package Outline



TO-263-3L Package Information

Package Outline

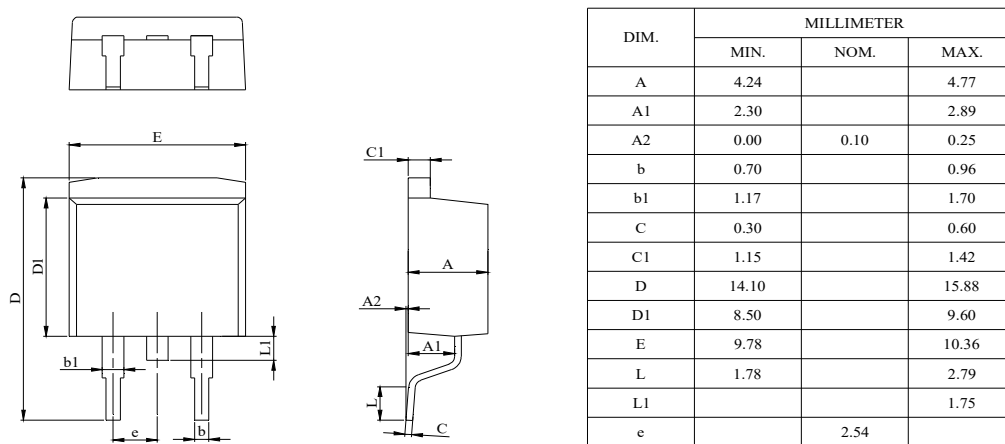

Recommended Footprint

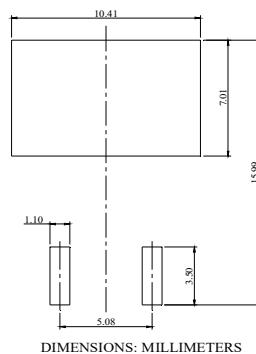

单击下面可查看定价，库存，交付和生命周期等信息

[>>JW\(捷捷微\)](#)