



## Description

### JMT N And P-Channel Enhancement Mode MOSFET

#### Features

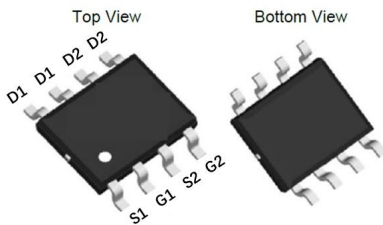
- N-Channel: 40V, 8A  
 $R_{DS(ON)} < 22m\Omega @ V_{GS} = 10V$   
 $R_{DS(ON)} < 35m\Omega @ V_{GS} = 4.5V$
- P-Channel: -40V, -6A  
 $R_{DS(ON)} < 53m\Omega @ V_{GS} = -10V$   
 $R_{DS(ON)} < 81m\Omega @ V_{GS} = -4.5V$
- Excellent Gate Charge x  $R_{DS(ON)}$  Product(FOM)
- Very Low On-resistance  $R_{DS(ON)}$
- Fast Switching Speed

#### Application

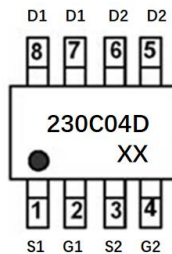
- Battery Protection
- Load Switch
- Power Management



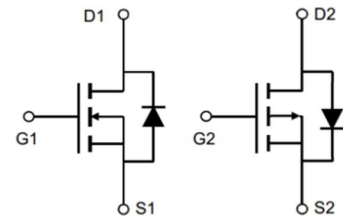
**100% UIS TESTED!**  
**100% ΔVds TESTED!**



SOP-8



Marking and pin Assignment



Schematic Diagram

## Package Marking and Ordering Information

Device Marking	Device	OUTLINE	Device Package	Reel Size	Reel (PCS)	Per Carton (PCS)
230C04D	JMTP230C04D	TAPING	SOP-8	13inch	4000	48000

## Absolute Maximum Ratings (T<sub>A</sub>=25°C unless otherwise specified)

Symbol	Parameter	Max. N-Channel	Max. P-Channel	Units
V <sub>DSS</sub>	Drain-Source Voltage	40	-40	V
V <sub>GSS</sub>	Gate-Source Voltage	±20	±20	V
I <sub>D</sub>	Continuous Drain Current	T <sub>A</sub> = 25°C	-6	A
		T <sub>A</sub> = 100°C	-3.9	A
I <sub>DM</sub>	Pulsed Drain Current <sup>note1</sup>	32	-24	A
E <sub>AS</sub>	Single Pulsed Avalanche Energy <sup>note2</sup>	13	17.6	mJ
P <sub>D</sub>	Power Dissipation	2	3.2	W
R <sub>θJA</sub>	Thermal Resistance, Junction to Ambient	62.5	39	°C/W
T <sub>J</sub> , T <sub>STG</sub>	Operating and Storage Temperature Range	-55 to +150		°C



## N-Channel Electrical Characteristics (T<sub>J</sub>=25°C unless otherwise specified)

Symbol	Parameter	Test Condition	Min.	Typ.	Max.	Units
<b>Off Characteristic</b>						
V <sub>(BR)DSS</sub>	Drain-Source Breakdown Voltage	V <sub>GS</sub> =0V, I <sub>D</sub> =250μA	40	-	-	V
I <sub>DSS</sub>	Zero Gate Voltage Drain Current	V <sub>DS</sub> =40V, V <sub>GS</sub> =0V	-	-	1.0	μA
I <sub>GSS</sub>	Gate to Body Leakage Current	V <sub>DS</sub> =0V, V <sub>GS</sub> =±20V	-	-	±100	nA
<b>On Characteristics</b>						
V <sub>GS(th)</sub>	Gate Threshold Voltage	V <sub>DS</sub> =V <sub>GS</sub> , I <sub>D</sub> =250μA	1.0	1.5	2.5	V
R <sub>DS(on)</sub>	Static Drain-Source on-Resistance <small>note3</small>	V <sub>GS</sub> =10V, I <sub>D</sub> =8A	-	17	22	mΩ
		V <sub>GS</sub> =4.5V, I <sub>D</sub> =5A	-	25	35	mΩ
<b>Dynamic Characteristics</b>						
C <sub>iss</sub>	Input Capacitance	V <sub>DS</sub> =20V, V <sub>GS</sub> =0V, f=1.0MHz	-	633	-	pF
C <sub>oss</sub>	Output Capacitance		-	67	-	pF
C <sub>rss</sub>	Reverse Transfer Capacitance		-	58	-	pF
Q <sub>g</sub>	Total Gate Charge	V <sub>DS</sub> =20V, I <sub>D</sub> =8A, V <sub>GS</sub> =10V	-	12	-	nC
Q <sub>gs</sub>	Gate-Source Charge		-	3.2	-	nC
Q <sub>gd</sub>	Gate-Drain("Miller") Charge		-	3.1	-	nC
<b>Switching Characteristics</b>						
t <sub>d(on)</sub>	Turn-on Delay Time	V <sub>DD</sub> = 20V, R <sub>L</sub> =2.5Ω V <sub>GS</sub> =10V, R <sub>REN</sub> =3Ω	-	4	-	ns
t <sub>r</sub>	Turn-on Rise Time		-	3	-	ns
t <sub>d(off)</sub>	Turn-off Delay Time		-	15	-	ns
t <sub>f</sub>	Turn-off Fall Time		-	2	-	ns
<b>Drain-Source Diode Characteristics and Maximum Ratings</b>						
I <sub>S</sub>	Maximum Continuous Drain to Source Diode Forward Current		-	-	8	A
I <sub>SM</sub>	Maximum Pulsed Drain to Source Diode Forward Current		-	-	32	A
V <sub>SD</sub>	Drain to Source Diode Forward Voltage	V <sub>GS</sub> =0V, I <sub>S</sub> = 8A	-	-	1.2	V

Notes:1. Repetitive Rating: Pulse Width Limited by Maximum Junction Temperature

2. EAS condition : T<sub>J</sub>=25°C, V<sub>DD</sub>=20V, V<sub>G</sub>=10V, L=0.5mH, R<sub>g</sub>=25Ω, I<sub>AS</sub>=7.2A

T<sub>J</sub>=25°C, V<sub>DD</sub>=-20V, V<sub>G</sub>= -10V, L=0.5mH, R<sub>g</sub>=25Ω, I<sub>AS</sub>=-8.4A

3. Pulse Test: Pulse Width≤300μs, Duty Cycle≤2%



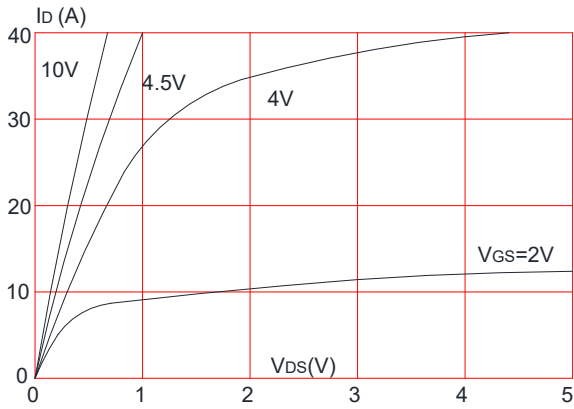
## P-Channel Electrical Characteristics (T<sub>J</sub>=25°C unless otherwise specified)

Symbol	Parameter	Test Condition	Min.	Typ.	Max.	Units
<b>Off Characteristic</b>						
V <sub>(BR)DSS</sub>	Drain-Source Breakdown Voltage	V <sub>GS</sub> =0V, I <sub>D</sub> = -250μA	-40	-	-	V
I <sub>DSS</sub>	Zero Gate Voltage Drain Current	V <sub>DS</sub> = -40V, V <sub>GS</sub> =0V	-	-	-1	μA
I <sub>GSS</sub>	Gate to Body Leakage Current	V <sub>DS</sub> =0V, V <sub>GS</sub> =±20V	-	-	±100	nA
<b>On Characteristics</b>						
V <sub>GS(th)</sub>	Gate Threshold Voltage	V <sub>DS</sub> =V <sub>GS</sub> , I <sub>D</sub> = -250μA	-1.0	-1.6	-2.5	V
R <sub>DS(on)</sub>	Static Drain-Source on-Resistance <small>note3</small>	V <sub>GS</sub> = -10V, I <sub>D</sub> = -6A	-	41	53	mΩ
		V <sub>GS</sub> = -4.5V, I <sub>D</sub> = -4A	-	58	81	
<b>Dynamic Characteristics</b>						
C <sub>iss</sub>	Input Capacitance	V <sub>DS</sub> = -20V, V <sub>GS</sub> =0V, f=1.0MHz	-	860	-	pF
C <sub>oss</sub>	Output Capacitance		-	87	-	pF
C <sub>rss</sub>	Reverse Transfer Capacitance		-	70	-	pF
Q <sub>g</sub>	Total Gate Charge	V <sub>DS</sub> = -20V, I <sub>D</sub> = -6A, V <sub>GS</sub> = -10V	-	13	-	nC
Q <sub>gs</sub>	Gate-Source Charge		-	3.8	-	nC
Q <sub>gd</sub>	Gate-Drain("Miller") Charge		-	3.1	-	nC
<b>Switching Characteristics</b>						
t <sub>d(on)</sub>	Turn-on Delay Time	V <sub>DD</sub> = -20V, R <sub>L</sub> =2.3Ω V <sub>GS</sub> =-10V, R <sub>REN</sub> =6Ω	-	7.5	-	ns
t <sub>r</sub>	Turn-on Rise Time		-	5.5	-	ns
t <sub>d(off)</sub>	Turn-off Delay Time		-	19	-	ns
t <sub>f</sub>	Turn-off Fall Time		-	7	-	ns
<b>Drain-Source Diode Characteristics and Maximum Ratings</b>						
I <sub>S</sub>	Maximum Continuous Drain to Source Diode Forward Current		-	-	-6	A
I <sub>SM</sub>	Maximum Pulsed Drain to Source Diode Forward Current		-	-	-24	A
V <sub>SD</sub>	Drain to Source Diode Forward Voltage	V <sub>GS</sub> =0V, I <sub>S</sub> = -6A	-	-	-1.2	V

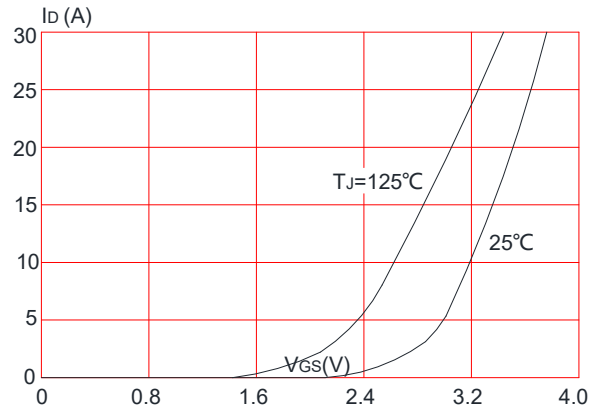


## Typical Performance Characteristics-N

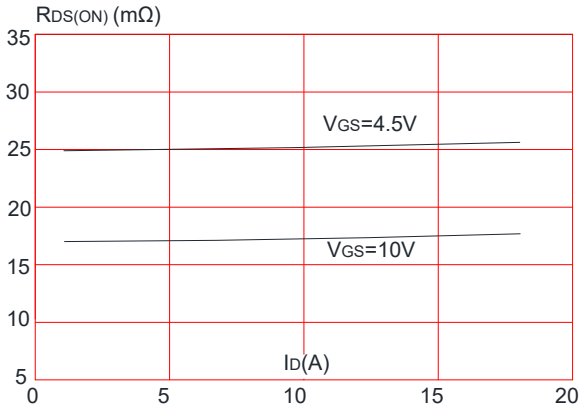
**Figure 1: Output Characteristics**



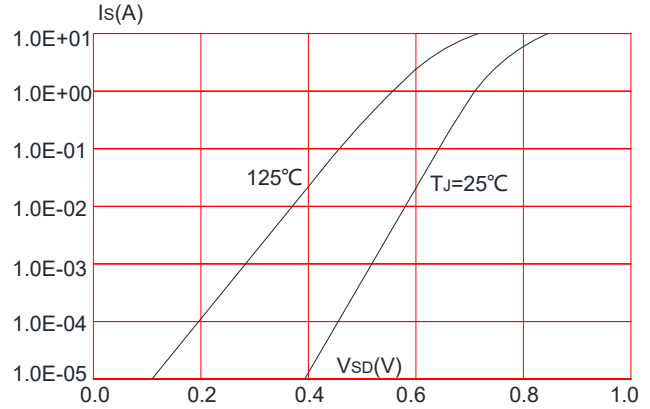
**Figure 2: Typical Transfer Characteristics**



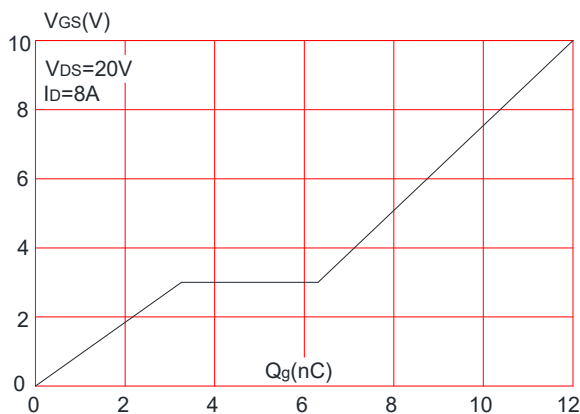
**Figure 3: On-resistance vs. Drain Current**



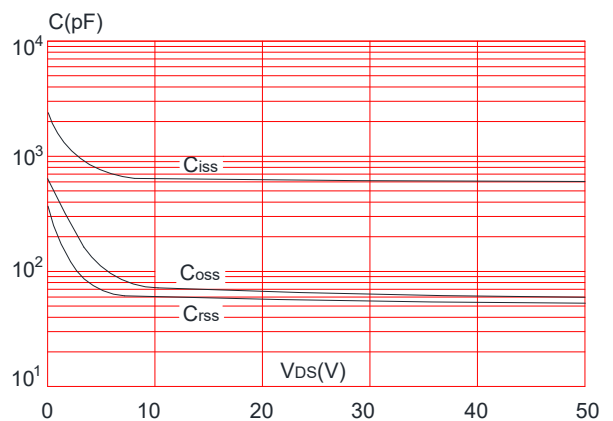
**Figure 4: Body Diode Characteristics**



**Figure 5: Gate Charge Characteristics**

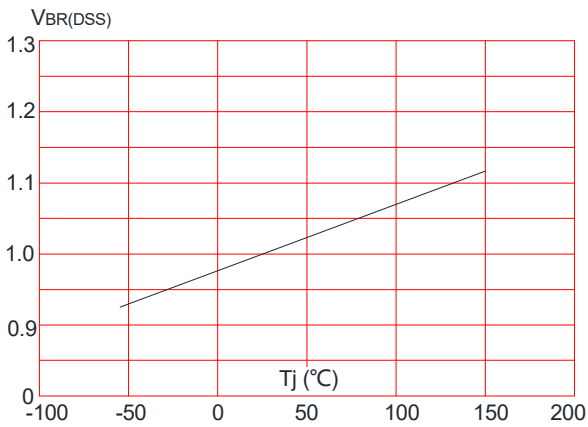


**Figure 6: Capacitance Characteristics**

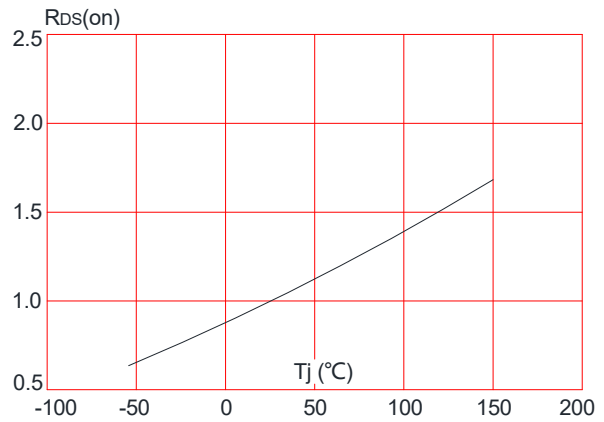




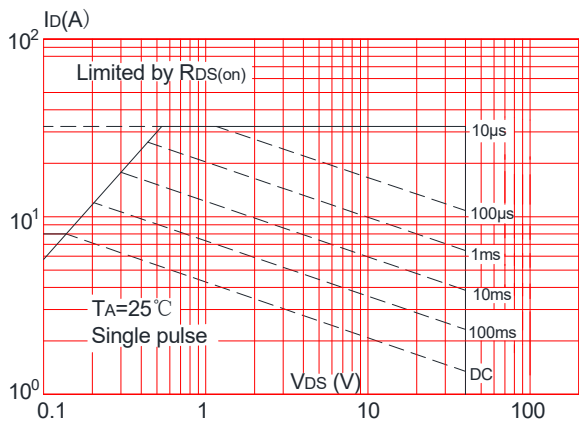
**Figure 7: Normalized Breakdown Voltage vs. Junction Temperature**



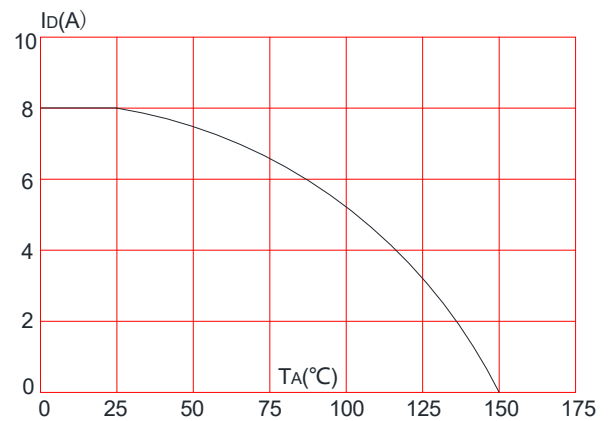
**Figure 8: Normalized on Resistance vs. Junction Temperature**



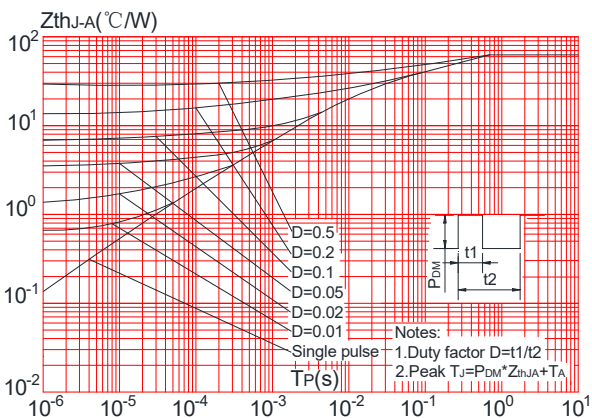
**Figure 9: Maximum Safe Operating Area**



**Figure 10: Maximum Continuous Drain Current vs. Ambient Temperature**



**Figure.11: Maximum Effective Transient Thermal Impedance, Junction-to-Ambient**



## Test Circuit-N

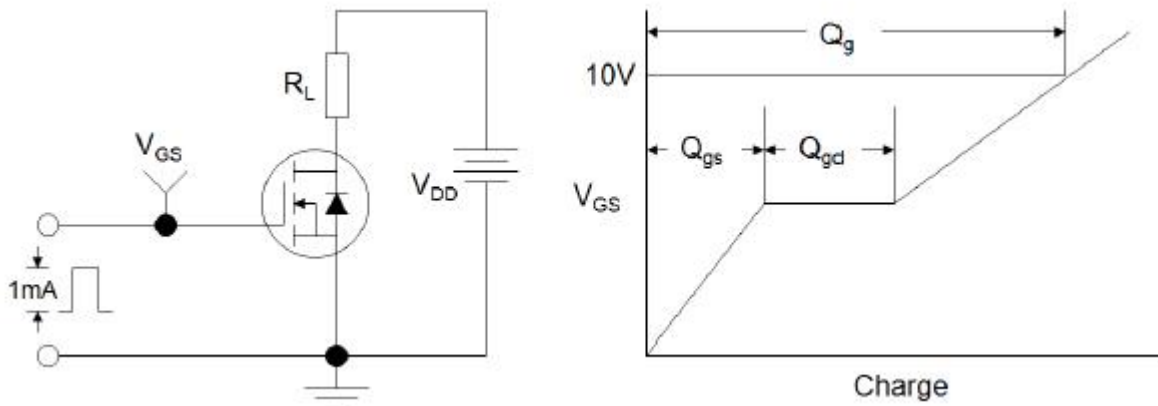


Figure1:Gate Charge Test Circuit & Waveform

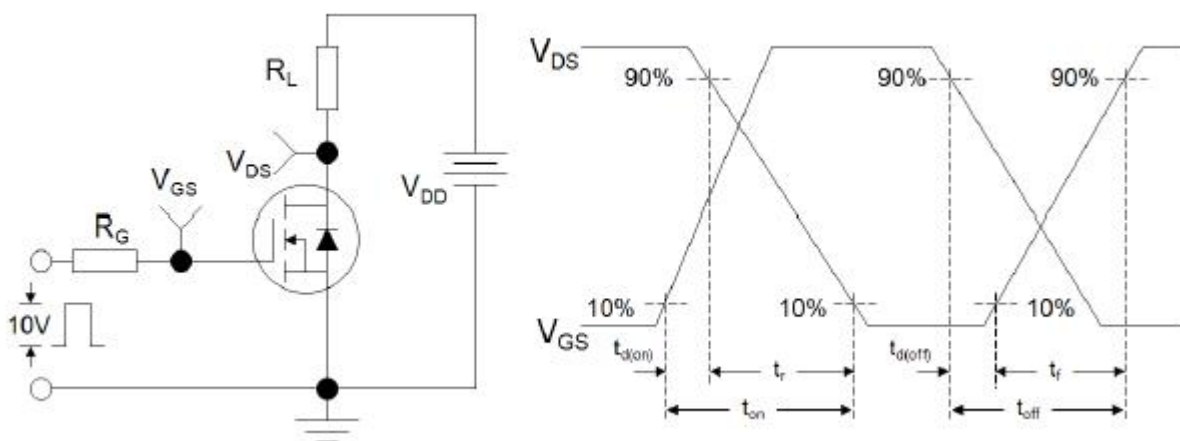


Figure 2: Resistive Switching Test Circuit & Waveforms

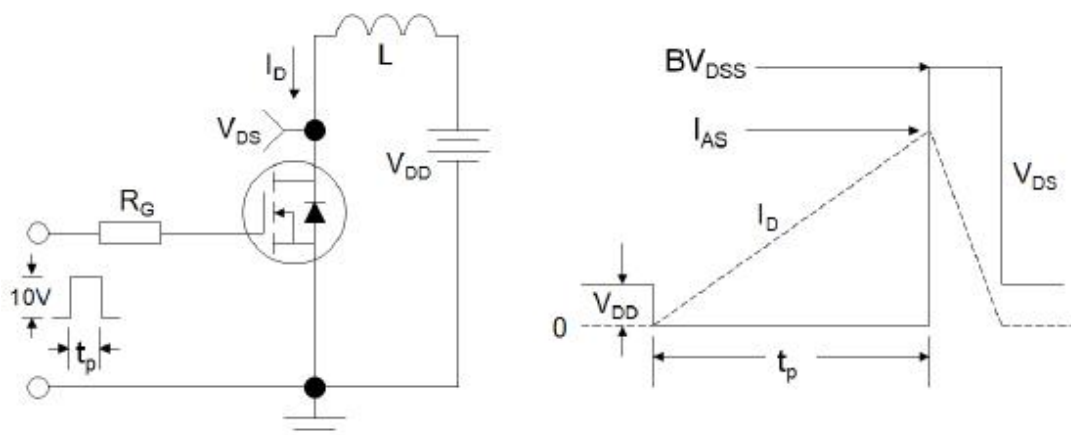
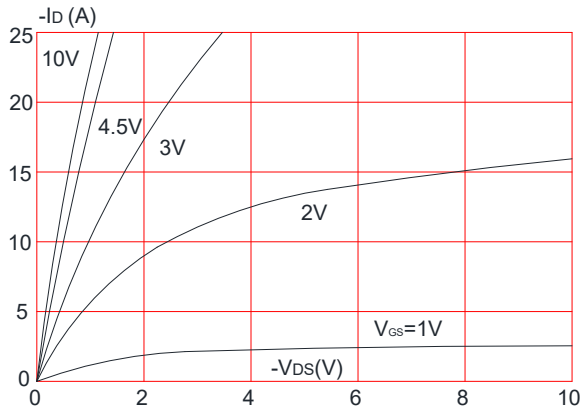


Figure 3:Unclamped Inductive Switching Test Circuit & Waveforms

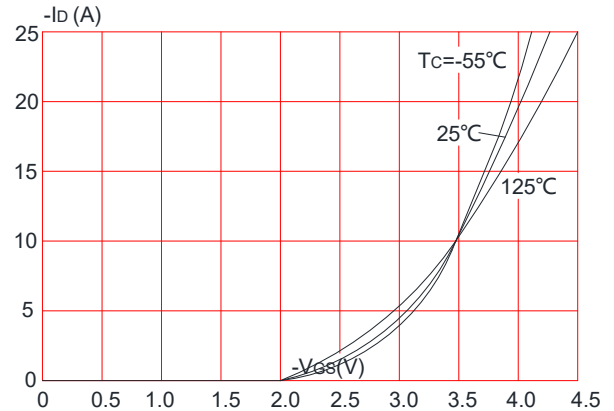


## Typical Performance Characteristics-P

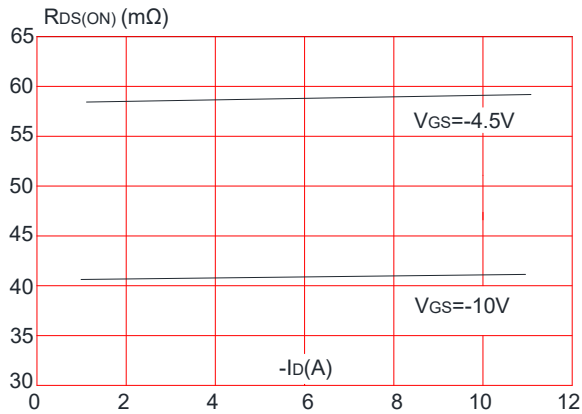
**Figure 1: Output Characteristics**



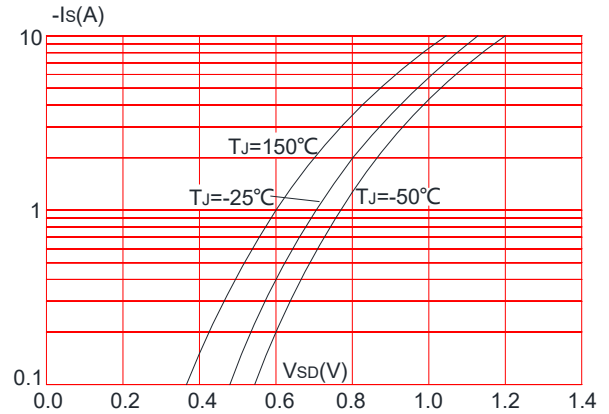
**Figure 2: Typical Transfer Characteristics**



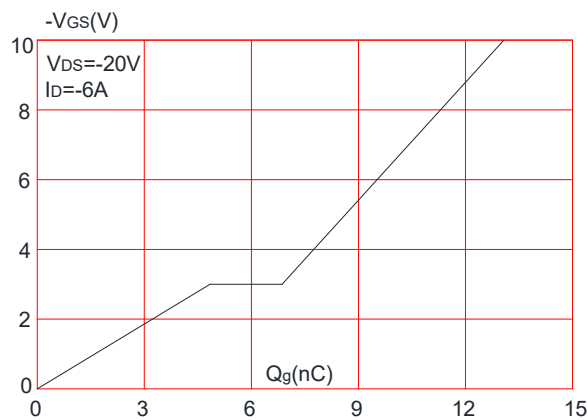
**Figure 3: On-resistance vs. Drain Current**



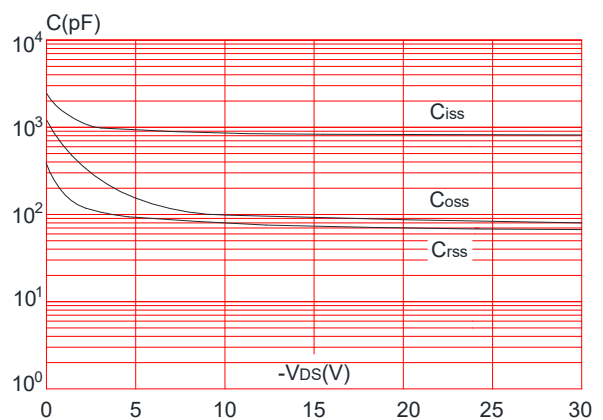
**Figure 4: Body Diode Characteristics**



**Figure 5: Gate Charge Characteristics**

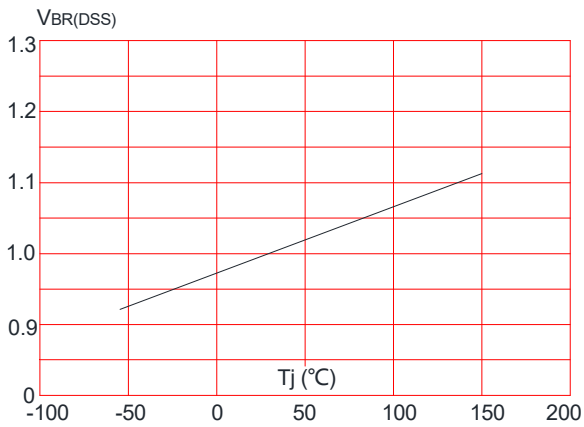


**Figure 6: Capacitance Characteristics**

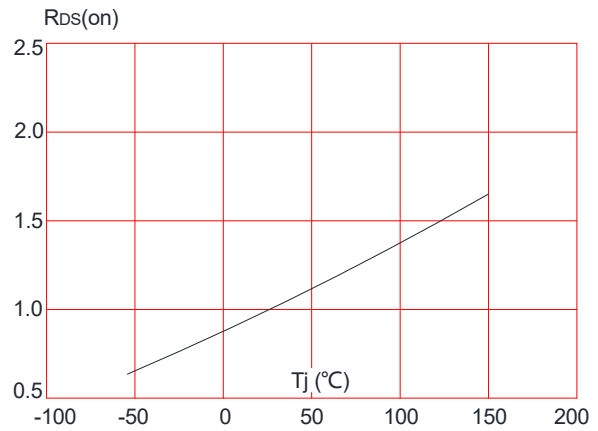




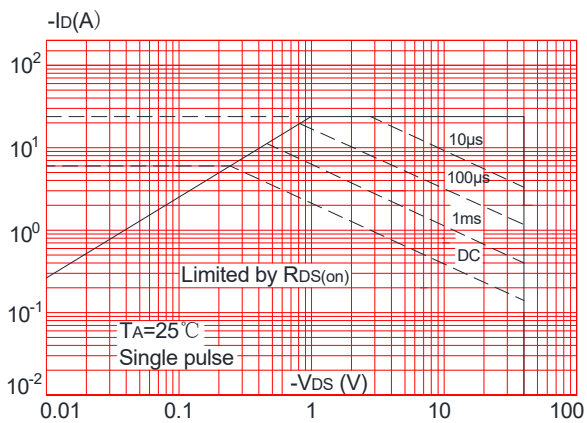
**Figure 7:** Normalized Breakdown Voltage vs. Junction Temperature



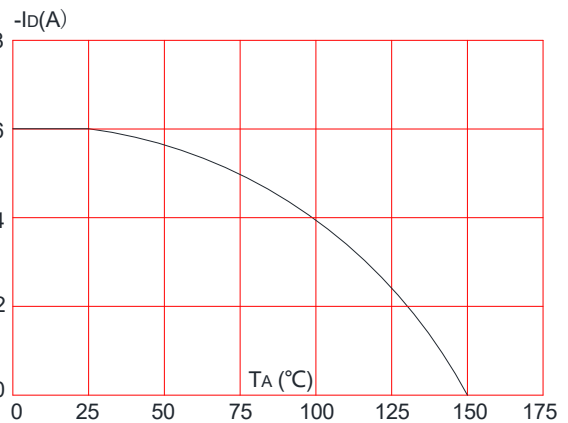
**Figure 8:** Normalized on Resistance vs. Junction Temperature



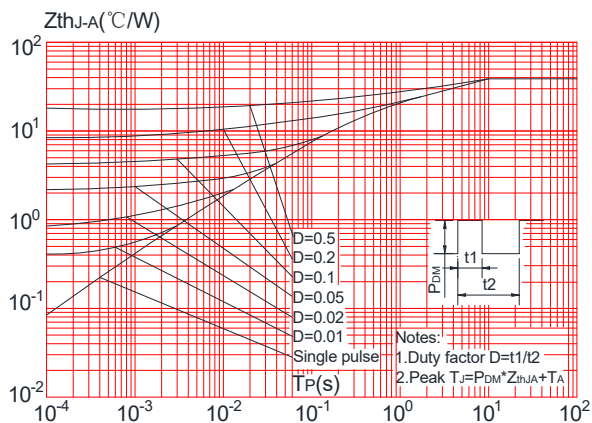
**Figure 9:** Maximum Safe Operating Area



**Figure 10:** Maximum Continuous Drain Current vs. Ambient Temperature



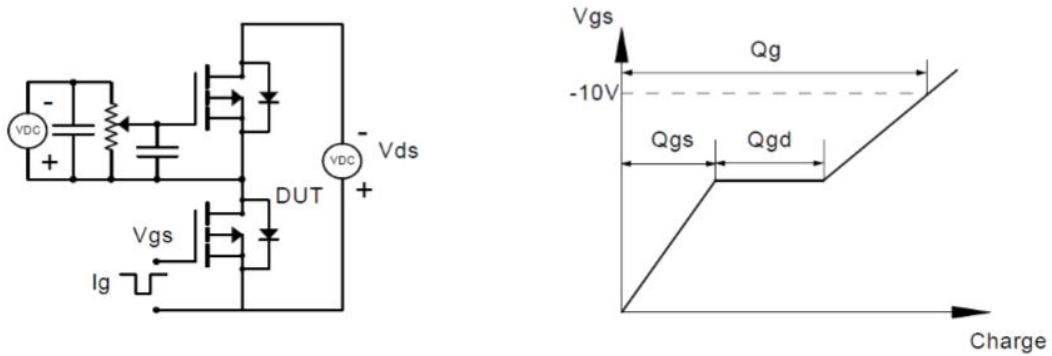
**Figure.11:** Maximum Effective Transient Thermal Impedance, Junction-to-Ambient



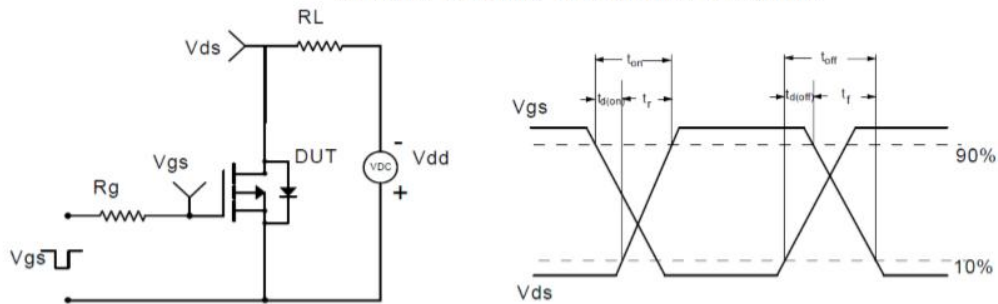


## Test Circuit-P

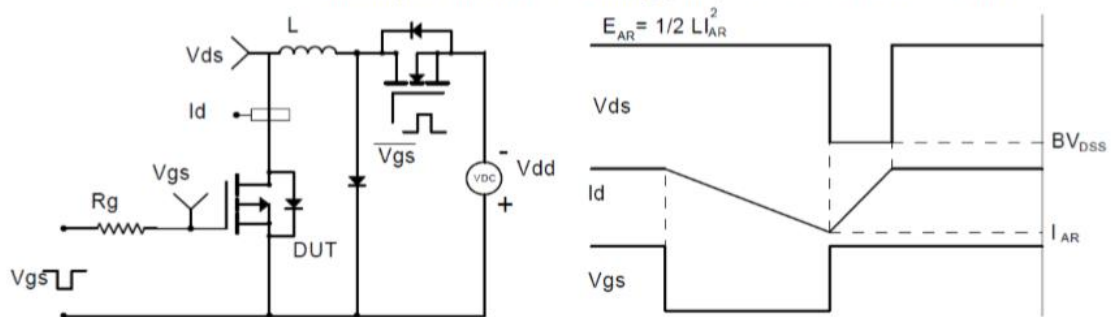
### Gate Charge Test Circuit & Waveform



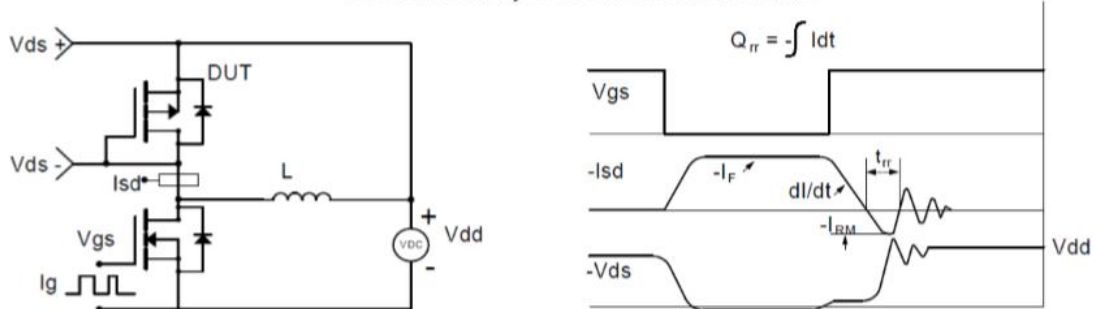
### Resistive Switching Test Circuit & Waveforms



### Unclamped Inductive Switching (UIS) Test Circuit & Waveforms

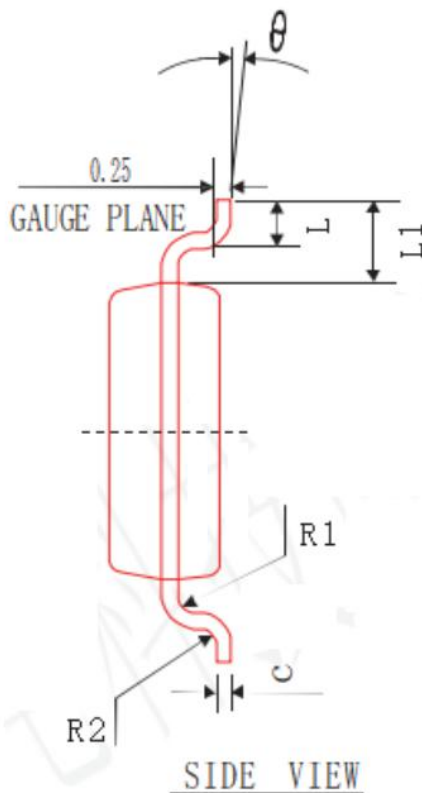
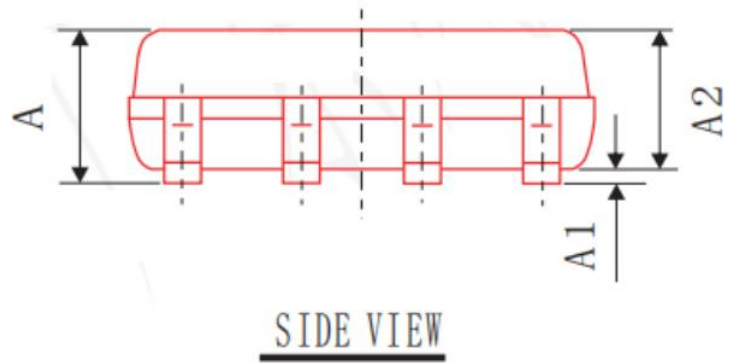
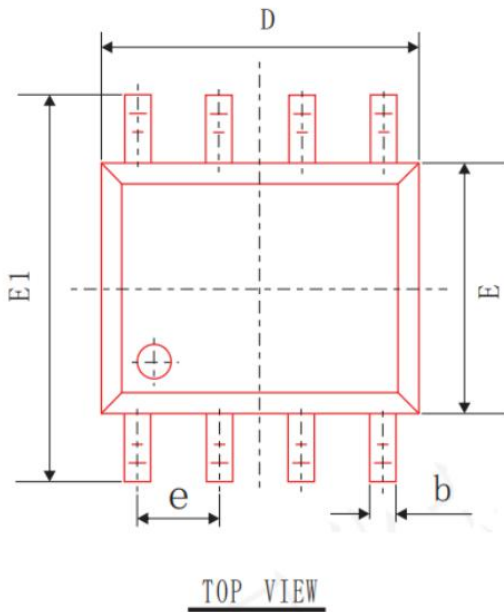


### Diode Recovery Test Circuit & Waveforms





## Package Mechanical Data-SOP-8




SYMBOL	MIN	NOM	MAX
A	1.40	1.60	1.80
A1	0.05	0.15	0.25
A2	1.35	1.45	1.55
b	0.30	0.40	0.50
c	0.153	0.203	0.253
D	4.80	4.90	5.00
E	3.80	3.90	4.00
E1	5.80	6.00	6.20
L	0.45	0.70	1.00
$\theta$	2°	4°	6°
L1	1.04 REF		
e	1.27 BSC		
R1	0.07 TYP		
R2	0.07 TYP		



Information furnished in this document is believed to be accurate and reliable. However, Jiangsu JieJie Microelectronics Co.,Ltd assumes no responsibility for the consequences of use without consideration for such information nor use beyond it.

Information mentioned in this document is subject to change without notice, apart from that when an agreement is signed, Jiangsu JieJie complies with the agreement.

Products and information provided in this document have no infringement of patents. Jiangsu JieJie assumes no responsibility for any infringement of other rights of third parties which may result from the use of such products and information.

 is a registered trademark of Jiangsu JieJie Microelectronics Co.,Ltd.  
Copyright ©2020 Jiangsu JieJie Microelectronics Co.,Ltd. Printed All rights reserved.

单击下面可查看定价，库存，交付和生命周期等信息

[>>JW\(捷捷微\)](#)