



## JST136C-600D 4A TRIACs

Rev.1

### DESCRIPTION:

With low holding and latching current, JST136C-600D triacs are especially recommended for use on middle and small resistance type power load. complying with UL standards (File ref: E252906). Package TO-220C is RoHS compliant. (2011/65/EU)

### MAIN FEATURES

Symbol	Value	Unit
$I_{T(RMS)}$	4	A
$V_{DRM}/V_{RRM}$	600	V

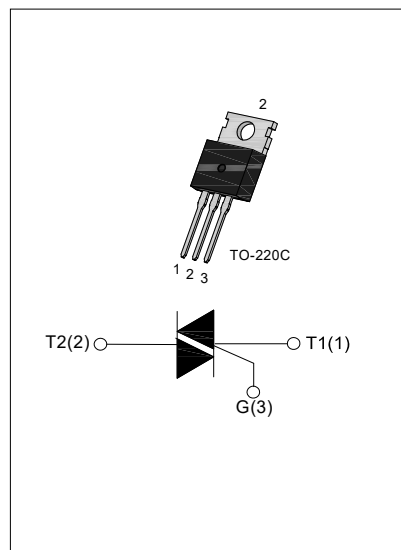

### ABSOLUTE MAXIMUM RATINGS

Parameter		Symbol	Value	Unit
Storage junction temperature range		$T_{stg}$	-40-150	°C
Operating junction temperature range		$T_j$	-40-125	°C
Repetitive peak off-state voltage( $T_j=25^\circ\text{C}$ )		$V_{DRM}$	600	V
Repetitive peak reverse voltage( $T_j=25^\circ\text{C}$ )		$V_{RRM}$	600	V
Non repetitive surge peak Off-state voltage		$V_{DSM}$	$V_{DRM} + 100$	V
Non repetitive peak reverse voltage		$V_{RSM}$	$V_{RRM} + 100$	V
RMS on-state current	TO-220C ( $T_C=105^\circ\text{C}$ )	$I_{T(RMS)}$	4	A
Non repetitive surge peak on-state current (full cycle, $F=50\text{Hz}$ )		$I_{TSM}$	35	A
$I^2t$ value for fusing ( $t_p=10\text{ms}$ )		$I^2t$	6.1	$\text{A}^2\text{s}$
Critical rate of rise of on-state current ( $I_G=2 \times I_{GT}$ )	I - II - III	$di/dt$	50	$\text{A}/\mu\text{s}$
	IV		10	
Peak gate current		$I_{GM}$	2	A
Average gate power dissipation		$P_{G(AV)}$	0.5	W
Peak gate power		$P_{GM}$	5	W

ELECTRICAL CHARACTERISTICS ( $T_j=25^{\circ}\text{C}$  unless otherwise specified)

Symbol	Test Condition	Quadrant		Value	Unit
$I_{GT}$	$V_D=12\text{V } R_L=30\Omega$	I - II -III	MAX	5	mA
		IV		10	
$V_{GT}$		ALL	MAX	1.3	V
$V_{GD}$	$V_D=V_{DRM} T_j=125^{\circ}\text{C}$ $R_L=3.3\text{K}\Omega$	ALL	MIN	0.2	V
$I_L$	$I_G=1.2I_{GT}$	I -III	MAX	20	mA
		II -IV		35	
$I_H$	$I_T=100\text{mA}$		MAX	15	mA
dv/dt	$V_D=2/3V_{DRM}$ Gate Open $T_j=125^{\circ}\text{C}$		MIN	50	V/ $\mu\text{s}$
(dv/dt) <sub>c</sub>	(dl/dt) <sub>c</sub> =1.7A/ms $T_j=125^{\circ}\text{C}$		MIN	0.1	V/ $\mu\text{s}$

## STATIC CHARACTERISTICS

Symbol	Parameter		Value(MAX)	Unit
$V_{TM}$	$I_{TM}=5.5\text{A } t_p=380\mu\text{s}$	$T_j=25^{\circ}\text{C}$	1.6	V
$V_{TO}$	Threshold voltage	$T_j=125^{\circ}\text{C}$	0.94	V
$R_d$	Dynamic resistance	$T_j=125^{\circ}\text{C}$	105	m $\Omega$
$I_{DRM}$	$V_D=V_{DRM} V_R=V_{RRM}$	$T_j=25^{\circ}\text{C}$	5	$\mu\text{A}$
$I_{RRM}$		$T_j=125^{\circ}\text{C}$	0.5	mA

## THERMAL RESISTANCES

Symbol	Parameter		Value	Unit
$R_{th(j-c)}$	junction to case(AC)	TO-220C	2.5	$^{\circ}\text{C}/\text{W}$

**ORDERING INFORMATION**

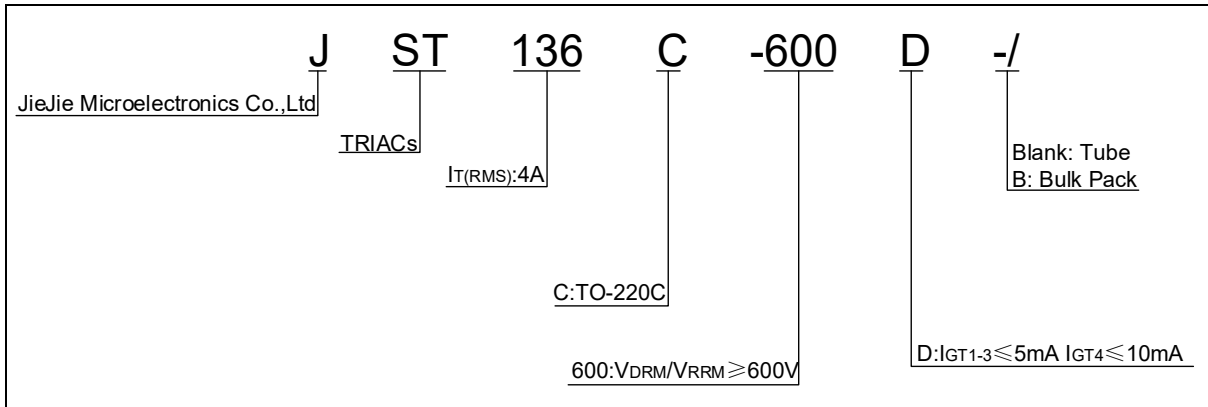

**MARKING**

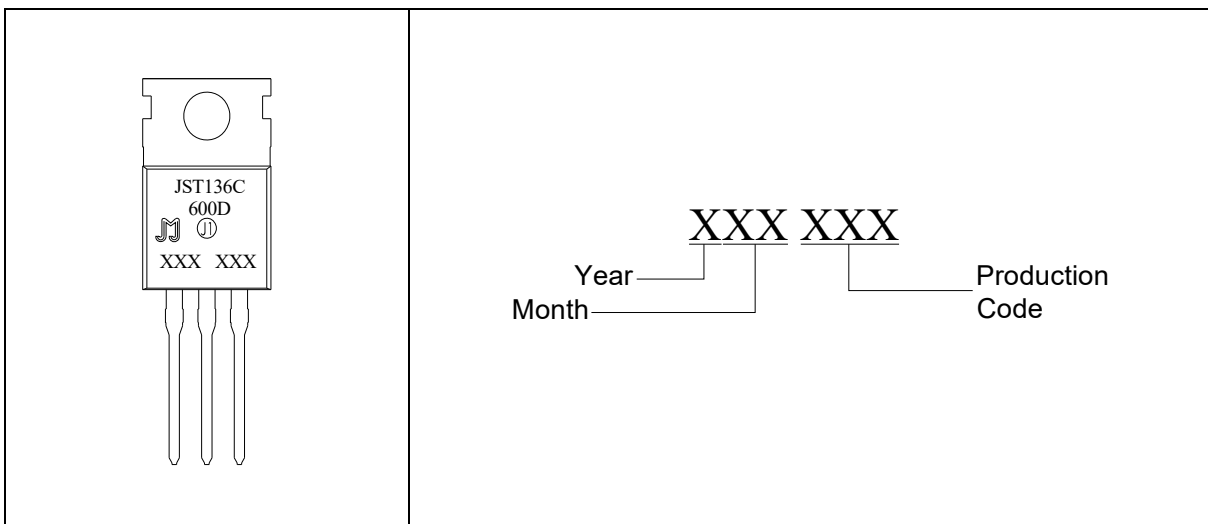

**FIG.1:** Maximum power dissipation versus RMS on-state current

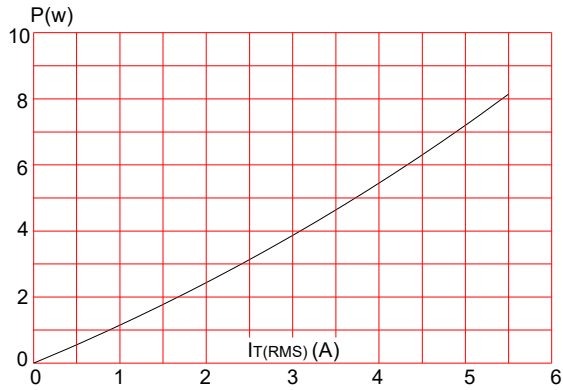

**FIG.2:** RMS on-state current versus case temperature

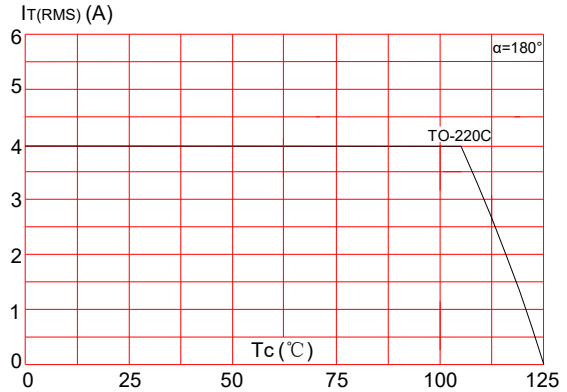

**FIG.3:** Surge peak on-state current versus number of cycles

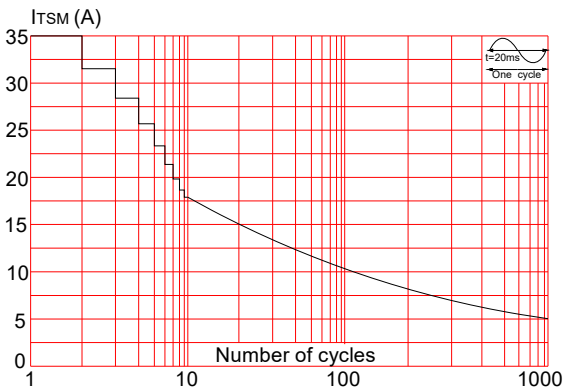

**FIG.4:** On-state characteristics (maximum values)

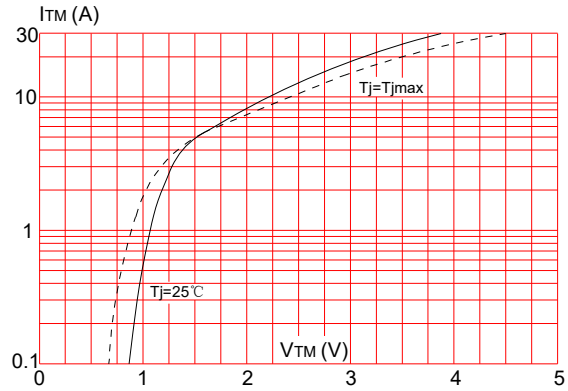

**FIG.5:** Non-repetitive surge peak on-state current for a sinusoidal pulse with width  $t_p < 20\text{ms}$  and corresponding value of  $I^2t$  ( I - II - III:  $dI/dt < 50\text{A}/\mu\text{s}$ ; IV:  $dI/dt < 10\text{A}/\mu\text{s}$ )

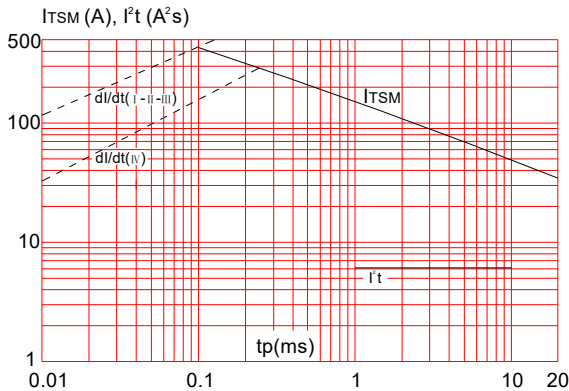

**FIG.6:** Relative variations of gate trigger current versus junction temperature

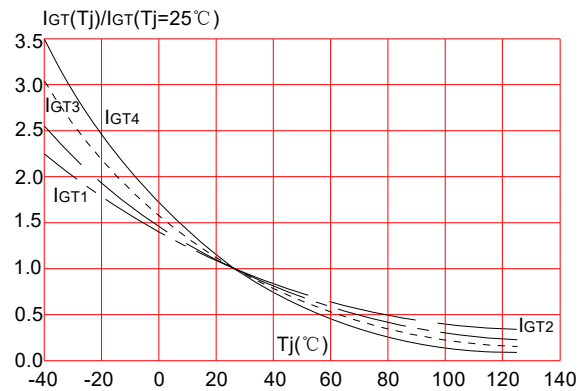

**FIG.7:** Relative variations of holding current versus junction temperature

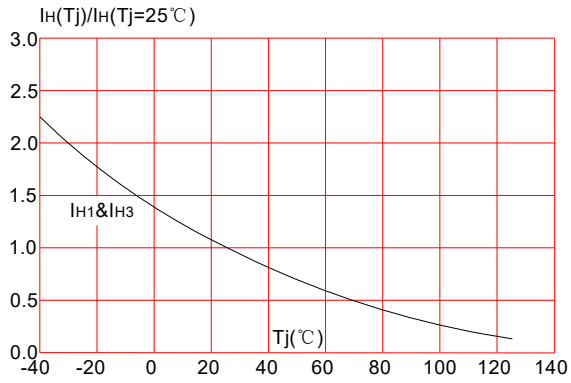

**FIG.8:** Relative variations of latching current versus junction temperature

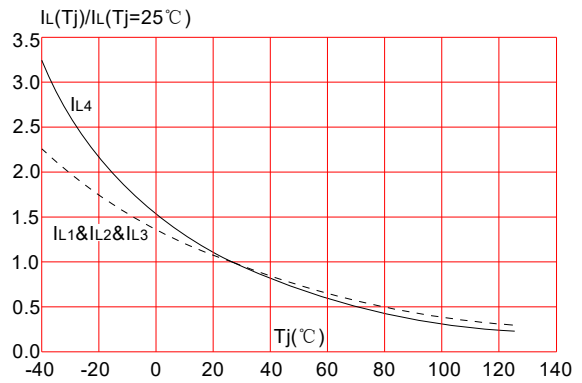

**ORDERING INFORMATION**

Order code	Voltage $V_{DRM}/V_{RRM}$ (V)	IGT(mA)		Package	Base qty. (pcs)	Delivery mode
		I - II - III	IV			
JST136C-600D	600	5	10	TO-220C	50	Tube

**Document Revision History**

Date	Revision	Changes
Mar 16, 2022	1	Last update

PACKAGE MECHANICAL DATA

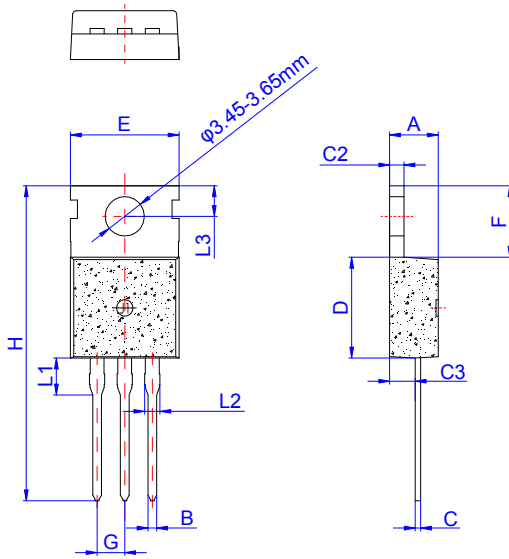

Ref.	Dimensions					
	Millimeters			Inches		
	Min.	Typ.	Max.	Min.	Typ.	Max.
A	4.40		4.60	0.173		0.181
B	0.70		0.90	0.028		0.035
C	0.45		0.60	0.018		0.024
C2	1.23		1.32	0.048		0.052
C3	2.20		2.60	0.087		0.102
D	8.90		9.90	0.350		0.390
E	9.90		10.3	0.390		0.406
F	6.30		6.90	0.248		0.272
G		2.54			0.1	
H	28.0		29.8	1.102		1.173
L1		3.39			0.133	
L2	1.14		1.70	0.045		0.067
L3	2.65		2.95	0.104		0.116

DELIVERY MODE

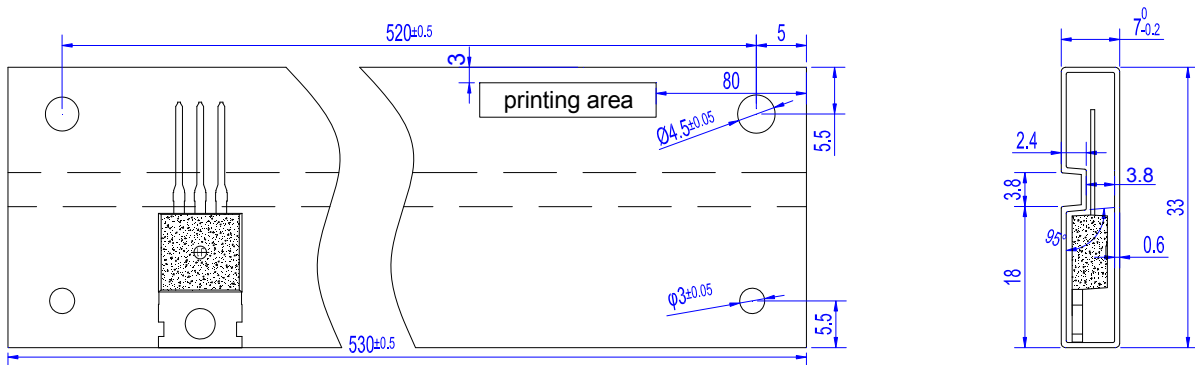

PACKAGE	OUTLINE	TUBE (PCS)	INNER BOX (PCS)	PER CARTON
TO-220C	TUBE	50	1,000	5,000



Information furnished in this document is believed to be accurate and reliable. However, Jiangsu JieJie Microelectronics Co.,Ltd assumes no responsibility for the consequences of use without consideration for such information nor use beyond it. Information mentioned in this document is subject to change without notice, apart from that when an agreement is signed, Jiangsu JieJie complies with the agreement. Products and information provided in this document have no infringement of patents. Jiangsu JieJie assumes no responsibility for any infringement of other rights of third parties which may result from the use of such products and information. This document supersedes and replaces all information previously supplied.

 is a registered trademark of Jiangsu JieJie Microelectronics Co.,Ltd.

Copyright ©2022 Jiangsu JieJie Microelectronics Co.,Ltd. Printed All rights reserved.

单击下面可查看定价，库存，交付和生命周期等信息

[>>JW\(捷捷微\)](#)