

Description

JMT P-channel Enhancement Mode Power MOSFET

Features

- $V_{DS} = -30V$, $I_D = -4.1A$
 $R_{DS(ON)} < 55m\Omega @ V_{GS} = -10V$
 $R_{DS(ON)} < 85m\Omega @ V_{GS} = -4.5V$
- Advanced Trench Technology
- Excellent $R_{DS(ON)}$ and Low Gate Charge
- Lead free product is acquired

Application

- PWM Applications
- Load Switch
- Power Management

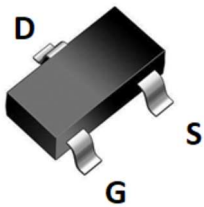

SOT-23 top view

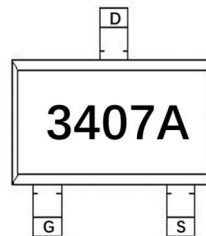

Marking and pin Assignment

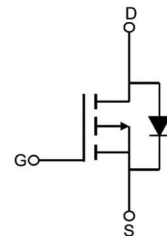

Schematic Diagram

Package Marking and Ordering Information

| Device Marking | Device | OUTLINE | Device Package | Reel Size | Reel (PCS) | Per Carton (PCS) |
|----------------|-----------|---------|----------------|-----------|------------|------------------|
| 3407A | JMTL3407A | TAPING | SOT-23 | 7inch | 3000 | 180000 |

Absolute Maximum Ratings ($T_A = 25^\circ C$ unless otherwise specified)

| Symbol | Parameter | Max. | Units | |
|-----------------|-----------------------------------------|---------------------|--------------|---|
| V_{DSS} | Drain-Source Voltage | -30 | V | |
| V_{GSS} | Gate-Source Voltage | ± 20 | V | |
| I_D | Continuous Drain Current | $T_A = 25^\circ C$ | -4.1 | A |
| | | $T_A = 100^\circ C$ | -2.7 | A |
| I_{DM} | Pulsed Drain Current ^{note1} | -16.4 | A | |
| P_D | Power Dissipation | $T_A = 25^\circ C$ | 1.51 | W |
| $R_{\theta JA}$ | Thermal Resistance, Junction to Ambient | 83 | $^\circ C/W$ | |
| T_J, T_{STG} | Operating and Storage Temperature Range | -55 to +150 | $^\circ C$ | |



Electrical Characteristics (T_J=25°C unless otherwise specified)

| Symbol | Parameter | Test Condition | Min. | Typ. | Max. | Units |
|---------------------------------------------------------------|-----------------------------------------------------------|--------------------------------------------------------------------------------------------------|------|------|-------|-------|
| Off Characteristic | | | | | | |
| V _{(BR)DSS} | Drain-Source Breakdown Voltage | V _{GS} = 0V, I _D = -250μA | -30 | - | - | V |
| I _{DSS} | Zero Gate Voltage Drain Current | V _{DS} = -30V, V _{GS} = 0V, | - | - | -1 | μA |
| I _{GSS} | Gate to Body Leakage Current | V _{DS} = 0V, V _{GS} = ±20V | - | - | ±100 | nA |
| On Characteristics | | | | | | |
| V _{GS(th)} | Gate Threshold Voltage | V _{DS} = V _{GS} , I _D = -250μA | -1.0 | -1.5 | -2.5 | V |
| R _{DS(on)} | Static Drain-Source on-Resistance <small>note2</small> | V _{GS} = -10V, I _D = -4A | - | 42 | 55 | mΩ |
| | | V _{GS} = -4.5V, I _D = -3A | - | 62 | 85 | |
| Dynamic Characteristics | | | | | | |
| C _{iss} | Input Capacitance | V _{DS} = -15V, V _{GS} = 0V, f = 1.0MHz | - | 580 | - | pF |
| C _{oss} | Output Capacitance | | - | 98 | - | pF |
| C _{rss} | Reverse Transfer Capacitance | | - | 74 | - | pF |
| Q _g | Total Gate Charge | V _{DS} = -15V, I _D = -4.1A, V _{GS} = -10V | - | 6.8 | - | nC |
| Q _{gs} | Gate-Source Charge | | - | 1 | - | nC |
| Q _{gd} | Gate-Drain("Miller") Charge | | - | 1.4 | - | nC |
| Switching Characteristics | | | | | | |
| t _{d(on)} | Turn-on Delay Time | V _{DD} = -15V, I _D = -1A, V _{GS} = -10V, R _{GEN} = 2.5Ω | - | 14 | - | ns |
| t _r | Turn-on Rise Time | | - | 61 | - | ns |
| t _{d(off)} | Turn-off Delay Time | | - | 19 | - | ns |
| t _f | Turn-off Fall Time | | - | 10 | - | ns |
| Drain-Source Diode Characteristics and Maximum Ratings | | | | | | |
| I _S | Maximum Continuous Drain to Source Diode Forward Current | | - | - | -4.1 | A |
| I _{SM} | Maximum Pulsed Drain to Source Diode Forward Current | | - | - | -16.4 | A |
| V _{SD} | Drain to Source Diode Forward Voltage | V _{GS} = 0V, I _S = -4.1A | - | -0.8 | -1.2 | V |

Notes:1. Repetitive Rating: Pulse Width Limited by Maximum Junction Temperature

2. Pulse Test: Pulse Width≤300μs, Duty Cycle≤2%



Figure 1: Output Characteristics

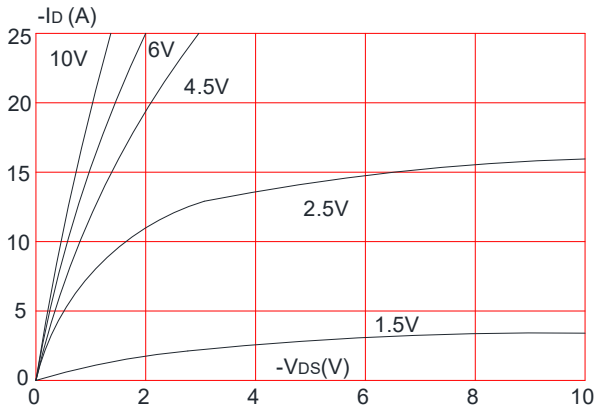

Figure 2: Typical Transfer Characteristics

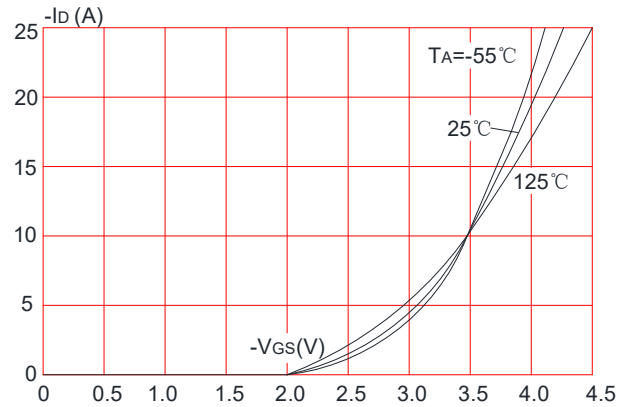

Figure 3: On-resistance vs. Drain Current

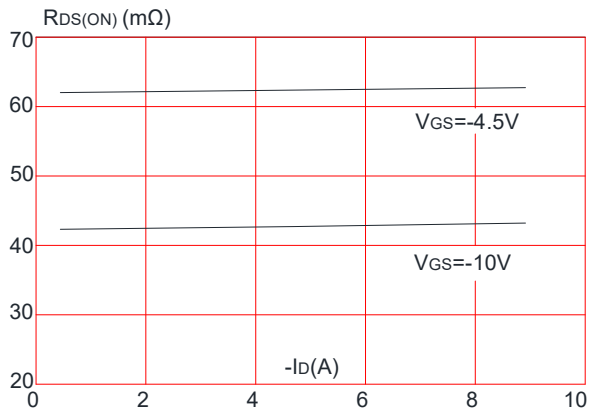

Figure 4: Body Diode Characteristics

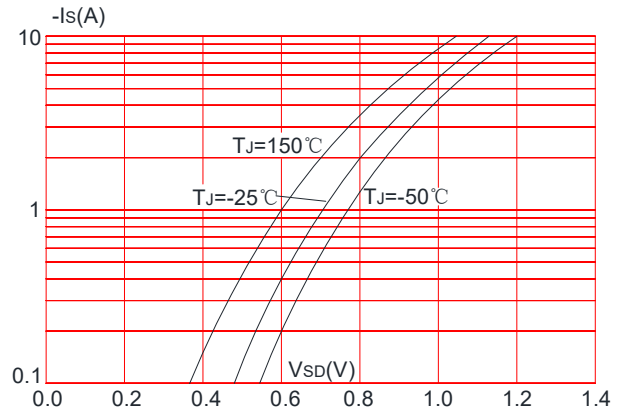

Figure 5: Gate Charge Characteristics

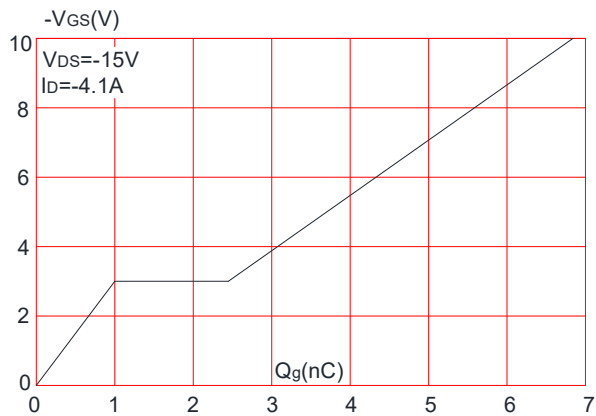

Figure 6: Capacitance Characteristics

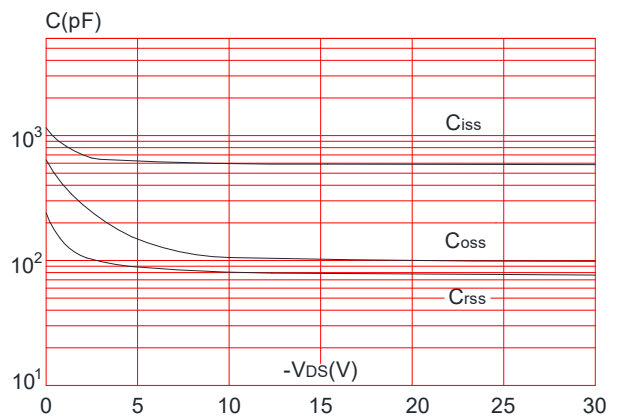

Figure 7: Normalized Breakdown Voltage vs. Junction Temperature

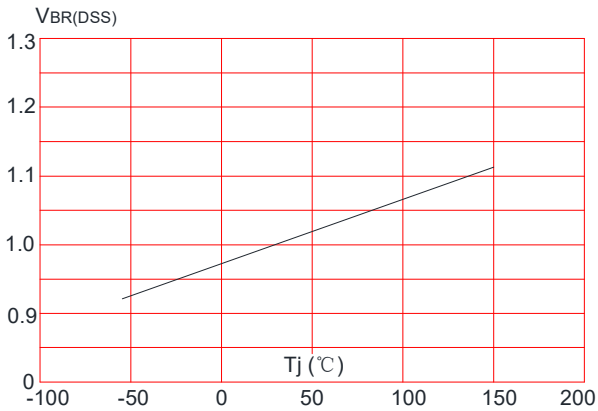

Figure 8: Normalized on Resistance vs. Junction Temperature

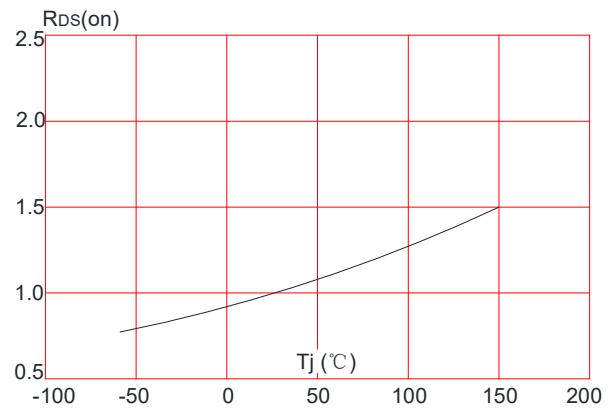

Figure 9: Maximum Safe Operating Area

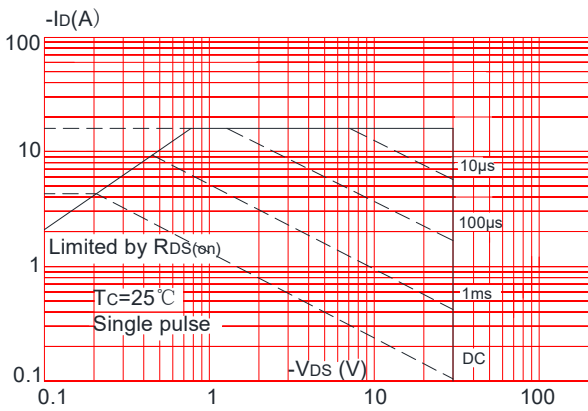

Figure 10: Maximum Continuous Drain Current vs. Ambient Temperature

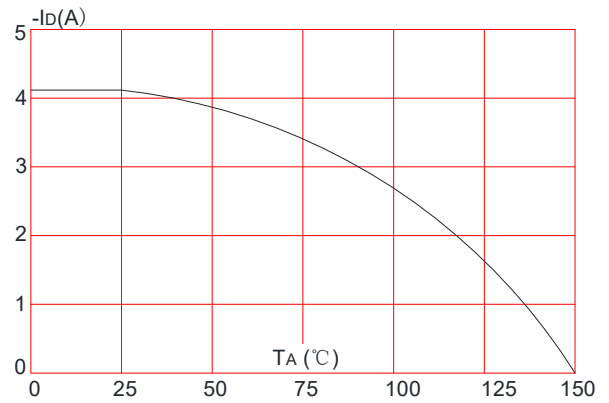
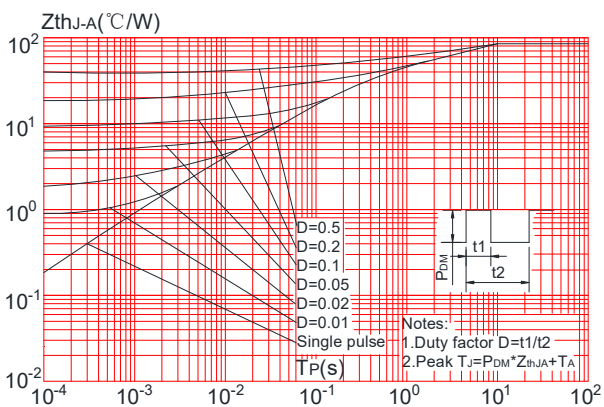
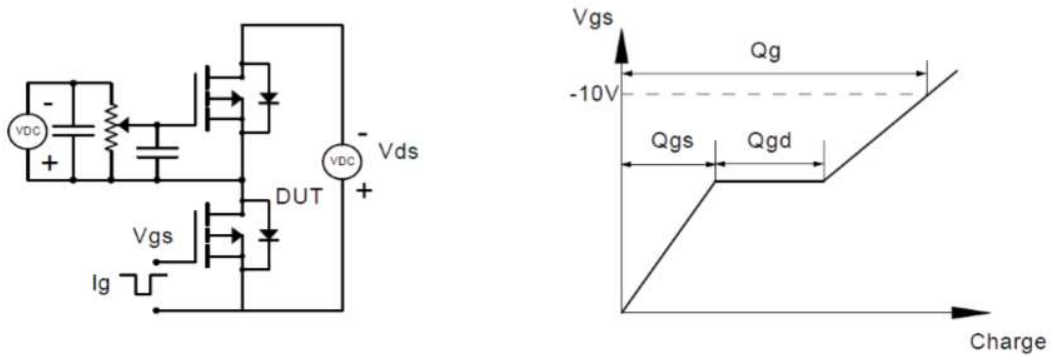

Figure.11: Maximum Effective Transient Thermal Impedance, Junction-to-Ambient



Typical Performance Characteristics

Gate Charge Test Circuit & Waveform



Resistive Switching Test Circuit & Waveforms

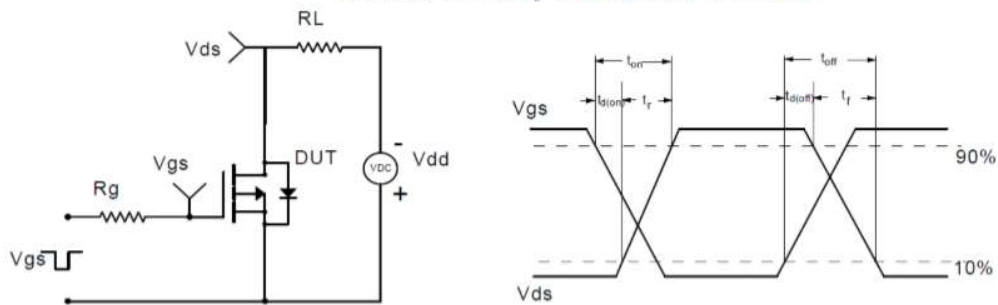

Unclamped Inductive Switching (UIS) Test Circuit & Waveforms

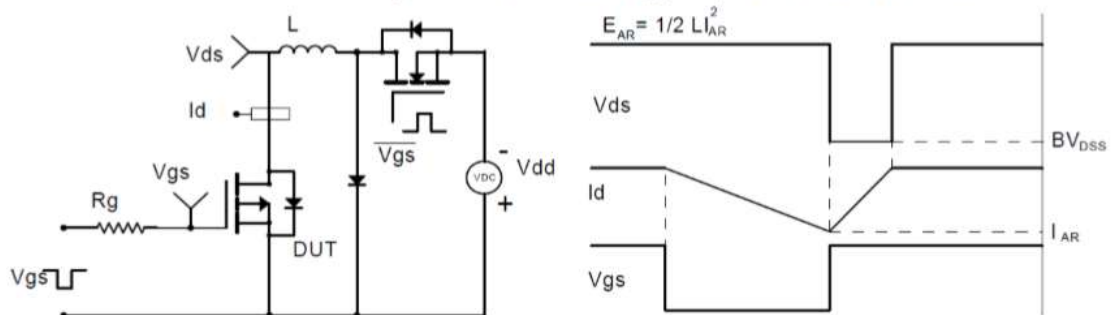

Diode Recovery Test Circuit & Waveforms

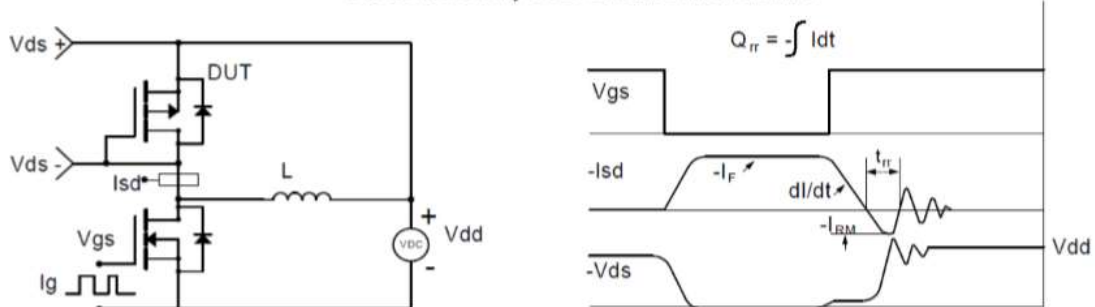

Package Mechanical Data-SOT-23

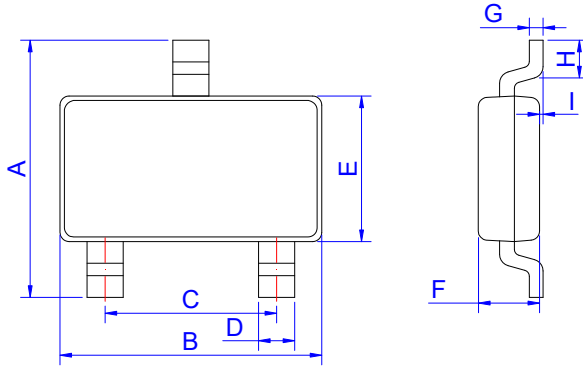

SOT-23

| Ref. | Dimensions | | | | | |
|------|-------------|------|------|-----------|-------|-------|
| | Millimeters | | | Inches | | |
| | Min. | Typ. | Max. | Min. | Typ. | Max. |
| A | 2.30 | 2.40 | 2.50 | 0.091 | 0.095 | 0.098 |
| B | 2.80 | 2.90 | 3.00 | 0.110 | 0.114 | 0.118 |
| C | 1.90 REF | | | 0.075 REF | | |
| D | 0.35 | 0.40 | 0.45 | 0.014 | 0.016 | 0.018 |
| E | 1.20 | 1.30 | 1.40 | 0.047 | 0.051 | 0.055 |
| F | 0.90 | 1.00 | 1.10 | 0.035 | 0.039 | 0.043 |
| G | | 0.10 | 0.15 | | 0.004 | 0.006 |
| H | 0.20 | | | 0.008 | | |
| I | 0 | | 0.10 | 0 | | 0.004 |

Package Information-SOT-23

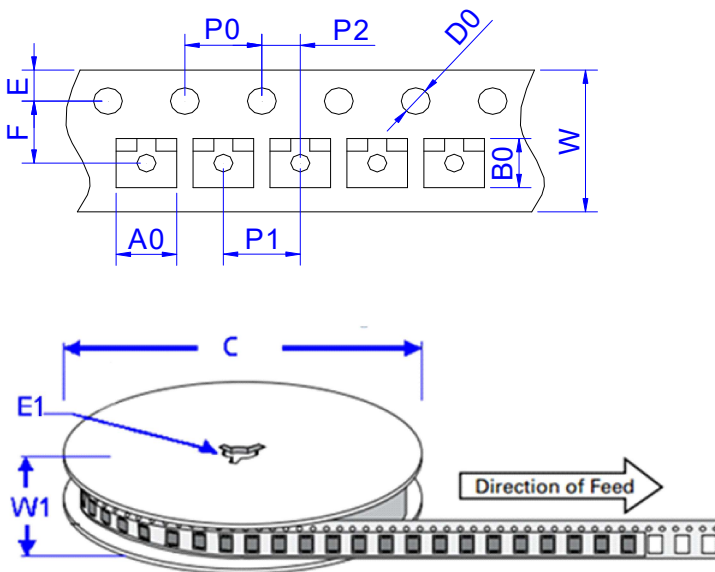

| Ref. | Dimensions | |
|------|-------------|---------------|
| | Millimeters | Inches |
| A0 | 3.15 ± 0.3 | 0.124 ± 0.012 |
| B0 | 2.77 ± 0.3 | 0.109 ± 0.012 |
| C | 178 | 7.0 |
| D0 | 1.50±0.1 | 0.059 ± 0.004 |
| E | 1.75 ± 0.2 | 0.069 ± 0.008 |
| E1 | 13.3±0.3 | 0.524± 0.012 |
| F | 3.5 ± 0.2 | 0.138 ± 0.008 |
| P0 | 4.00 ± 0.2 | 0.157 ± 0.008 |
| P1 | 4.00 ± 0.2 | 0.157 ± 0.008 |
| P2 | 2.00 ± 0.2 | 0.079 ± 0.008 |
| W | 8.00 ± 0.2 | 0.315 ± 0.008 |
| W1 | 11.5±1.0 | 0.453 ± 0.039 |



Information furnished in this document is believed to be accurate and reliable. However, Jiangsu JieJie Microelectronics Co.,Ltd assumes no responsibility for the consequences of use without consideration for such information nor use beyond it.

Information mentioned in this document is subject to change without notice, apart from that when an agreement is signed, Jiangsu JieJie complies with the agreement.

Products and information provided in this document have no infringement of patents. Jiangsu JieJie assumes no responsibility for any infringement of other rights of third parties which may result from the use of such products and information.

 is a registered trademark of Jiangsu JieJie Microelectronics Co.,Ltd.
Copyright ©2019 Jiangsu JieJie Microelectronics Co.,Ltd. Printed All rights reserved.

单击下面可查看定价，库存，交付和生命周期等信息

[>>JW\(捷捷微\)](#)