



1.5KE Series 1500W Transient Voltage Suppressor

Rev.2.6

DESCRIPTION:

The 1.5KE series of high current uni/bi-directional transient suppressors are designed for A.C. line protection and high power DC bus clamping applications. These devices offer uni/bi-directional port protection from 6.8 volts to 600 volts. They provide a clamping voltage lower than the avalanche voltage. Therefore, any voltage rise due to increased current conduction is contained to a minimum, providing the best possible protection level. They can also be connected in series and/or parallel to create very high capacity protection solutions.

FEATURES:

- ✧ Low incremental surge resistance.
- ✧ Excellent clamping capability.
- ✧ Color band denoted cathode except bidirectional.
- ✧ Typical I_R less than $1\mu A$ above 12V.
- ✧ High temperature wave soldering: $265^{\circ}C/10s$ at terminals.
- ✧ Plastic package has underwriters laboratory flammability 94V-0.
- ✧ 1500W peak pulse power capability at 10/1000 μs waveform.
- ✧ Meets MSL level 1, per J-STD-020, LF maximum peak of $260^{\circ}C$.
- ✧ Terminal: solder plated, solderable per J-STD-002.
- ✧ Fast response time: typically less than 1.0ps from 0V to V_{BR} min.
- ✧ UL 497B item recognized. (File No.:E480698).
- ✧ IEC61000-4-2 (ESD) $\pm 30kV$ (air), $\pm 30kV$ (contact).

ABSOLUTE MAXIMUM RATINGS($T_A=25^{\circ}C$, RH=45%-75%, unless otherwise noted)

Parameter	Symbol	Value	Unit
Operating junction and storage temperature range	T_J, T_{STG}	-55 to +175	$^{\circ}C$
Steady state power dissipation at $T_L=75^{\circ}C$	$P_{M(AV)}$	6.5	W
Peak pulse power dissipation at 10/1000 μs waveform	P_{PP}	1500	W
Maximum instantaneous forward voltage at 100A for unidirectional	V_F	5.0	V
Peak forward surge current, 8.3ms single half sine-wave(NOTE 1)	I_{FSM}	200	A

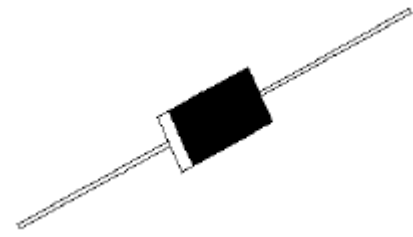

DO-27



Bi-directional



Uni-directional

Symbol

ABSOLUTE MAXIMUM RATINGS($T_A=25^{\circ}\text{C}$, RH=45%-75%, unless otherwise noted, continued)

Parameter	Symbol	Value	Unit
Typical thermal resistance junction to lead	$R_{\theta JL}$	15	$^{\circ}\text{C}/\text{W}$
Typical thermal resistance junction to ambient	$R_{\theta JA}$	75	$^{\circ}\text{C}/\text{W}$

Notes:

- 1 . Measured on 8.3ms single half sine wave or equivalent square wave for unidirectional device only, duty cycle=4 per minute maximum

ELECTRICAL CHARACTERISTICS($T_A=25^{\circ}\text{C}$)

Part Number		V_R	$I_R@V_R$	$V_{BR}@I_T$		I_T	$V_C@I_{PP}$	$I_{PP}^{\text{①}}$
Uni-Polar	Bi-Polar	V	max(μA)	min(V)	max(V)	mA	max(V)	A
1.5KE6.8A	1.5KE6.8CA	5.8	300	6.45	7.14	10	10.5	144.8
1.5KE7.5A	1.5KE7.5CA	6.4	150	7.13	7.88	10	11.3	134.5
1.5KE8.2A	1.5KE8.2CA	7.02	100	7.79	8.61	10	12.1	125.6
1.5KE9.1A	1.5KE9.1CA	7.78	50	8.65	9.55	1	13.4	113.4
1.5KE10A	1.5KE10CA	8.55	20	9.50	10.50	1	14.5	104.8
1.5KE11A	1.5KE11CA	9.4	5	10.50	11.60	1	15.6	97.4
1.5KE12A	1.5KE12CA	10.2	2	11.40	12.60	1	16.7	91.0
1.5KE13A	1.5KE13CA	11.1	1	12.40	13.70	1	18.2	83.5
1.5KE15A	1.5KE15CA	12.8	1	14.30	15.80	1	21.2	71.7
1.5KE16A	1.5KE16CA	13.6	1	15.20	16.80	1	22.5	67.6
1.5KE18A	1.5KE18CA	15.3	1	17.10	18.90	1	25.2	60.3
1.5KE20A	1.5KE20CA	17.1	1	19.00	21.00	1	27.7	54.9
1.5KE22A	1.5KE22CA	18.8	1	20.90	23.10	1	30.6	49.7
1.5KE24A	1.5KE24CA	20.5	1	22.80	25.20	1	33.2	45.8
1.5KE27A	1.5KE27CA	23.1	1	25.70	28.40	1	37.5	40.5
1.5KE30A	1.5KE30CA	25.6	1	28.50	31.50	1	41.4	36.7
1.5KE33A	1.5KE33CA	28.2	1	31.40	34.70	1	45.7	33.3
1.5KE36A	1.5KE36CA	30.8	1	34.20	37.80	1	49.9	30.5
1.5KE39A	1.5KE39CA	33.3	1	37.10	41.00	1	53.9	28.2
1.5KE43A	1.5KE43CA	36.8	1	40.90	45.20	1	59.3	25.6
1.5KE47A	1.5KE47CA	40.2	1	44.70	49.40	1	64.8	23.5
1.5KE51A	1.5KE51CA	43.6	1	48.50	53.60	1	70.1	21.7

ELECTRICAL CHARACTERISTICS ($T_A=25^{\circ}\text{C}$, continued)

Part Number		V_R	$I_R@V_R$	$V_{BR}@I_T$		I_T	$V_C@I_{PP}$	$I_{PP}^{①}$
Uni-Polar	Bi-Polar	V	max(μA)	min(V)	max(V)	mA	max(V)	A
1.5KE56A	1.5KE56CA	47.8	1	53.20	58.80	1	77.0	19.7
1.5KE62A	1.5KE62CA	53.0	1	58.90	65.10	1	85.0	17.9
1.5KE68A	1.5KE68CA	58.1	1	64.60	71.40	1	92.0	16.5
1.5KE75A	1.5KE75CA	64.1	1	71.30	78.80	1	103.0	14.8
1.5KE82A	1.5KE82CA	70.1	1	77.90	86.10	1	113.0	13.5
1.5KE91A	1.5KE91CA	77.8	1	86.50	95.50	1	125.0	12.2
1.5KE100A	1.5KE100CA	85.5	1	95.00	105.0	1	137.0	11.1
1.5KE110A	1.5KE110CA	94.0	1	105.0	116.0	1	152.0	10.0
1.5KE120A	1.5KE120CA	102.0	1	114.0	126.0	1	165.0	9.2
1.5KE130A	1.5KE130CA	111.0	1	124.0	137.0	1	179.0	8.5
1.5KE150A	1.5KE150CA	128.0	1	143.0	158.0	1	207.0	7.3
1.5KE160A	1.5KE160CA	136.0	1	152.0	168.0	1	219.0	6.9
1.5KE170A	1.5KE170CA	145.0	1	162.0	179.0	1	234.0	6.5
1.5KE180A	1.5KE180CA	154.0	1	171.0	189.0	1	246.0	6.2
1.5KE200A	1.5KE200CA	171.0	1	190.0	210.0	1	274.0	5.5
1.5KE220A	1.5KE220CA	185.0	1	209.0	231.0	1	328.0	4.6
1.5KE250A	1.5KE250CA	214.0	1	237.0	263.0	1	344.0	4.4
1.5KE300A	1.5KE300CA	256.0	1	285.0	315.0	1	414.0	3.7
1.5KE350A	1.5KE350CA	300.0	1	332.0	368.0	1	482.0	3.2
1.5KE400A	1.5KE400CA	342.0	1	380.0	420.0	1	548.0	2.8
1.5KE440A	1.5KE440CA	376.0	1	418.0	462.0	1	602.0	2.5
1.5KE480A	1.5KE480CA	408.0	1	456.0	504.0	1	658.0	2.3
1.5KE510A	1.5KE510CA	434.0	1	485.0	535.0	1	698.0	2.1
1.5KE540A	1.5KE540CA	460.0	1	513.0	567.0	1	740.0	2.0
1.5KE550A	1.5KE550CA	468.0	1	522.5	577.5	1	760.0	2.0
1.5KE600A	1.5KE600CA	512.0	1	570.0	630.0	1	828.0	1.8

① Surge waveform: 10/1000 μs V_R : Stand-off voltage -- Maximum voltage that can be applied V_{BR} : Breakdown voltage V_C : Clamping voltage -- Peak voltage measured across the suppressor at a specified I_{PP} I_R : Reverse leakage current

RATINGS AND V-I CHARACTERISTICS CURVES (T_A=25°C, unless otherwise noted)

FIG.1:V- I curve characteristics (Uni-directional)

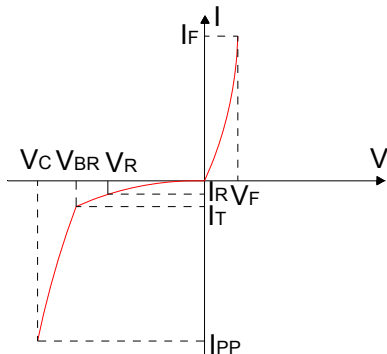

FIG.2:V- I curve characteristics (Bi-directional)

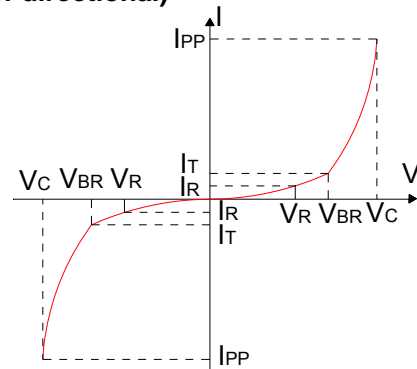

FIG.3: Pulse waveform

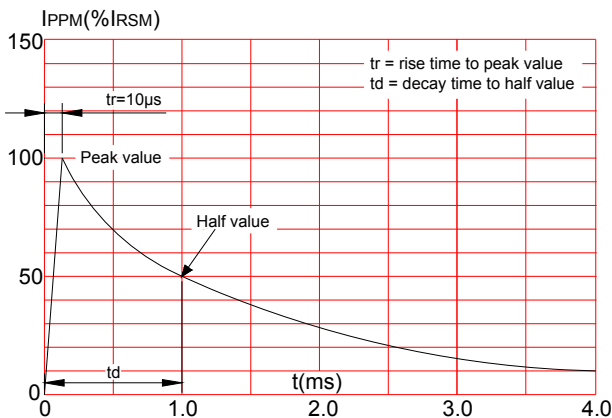
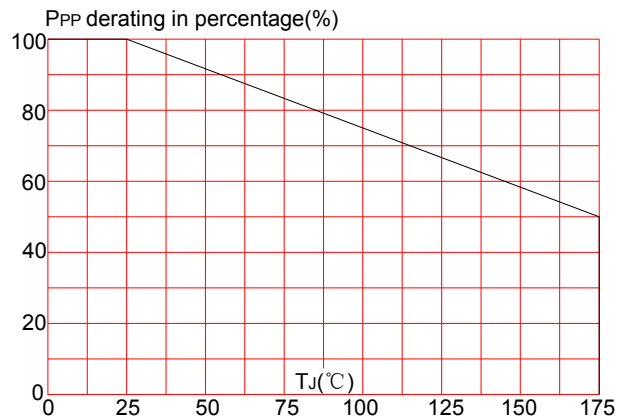
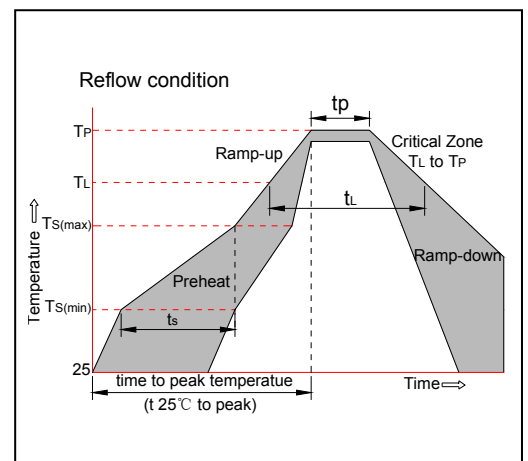

FIG.4: Pulse derating curve



SOLDERING PARAMETERS

Reflow Condition		Pb-Free assembly (see figure at right)
Pre Heat	-Temperature Min (T _{s(min)})	+150°C
	-Temperature Max(T _{s(max)})	+200°C
	-Time (Min to Max) (t _s)	60-180 secs.
Average ramp up rate (Liquidus Temp (T _L)to peak)		3°C/sec. Max
T _{s(max)} to T _L - Ramp-up Rate		3°C/sec. Max
Reflow	-Temperature(T _L)(Liquidus)	+217°C
	-Temperature(t _L)	60-150 secs.
Peak Temp (T _p)		+260(+0/-5)°C
Time within 5°C of actual Peak Temp (t _p)		20-40secs.
Ramp-down Rate		6°C/sec. Max
Time 25°C to Peak Temp (T _p)		8 min. Max
Do not exceed		+260°C



Flow/Wave Soldering(Solder Dipping)	
Peak temperature	265°C
Dipping time	10 sec.
Soldering	1 time

MARKING & ORDERING INFORMATION

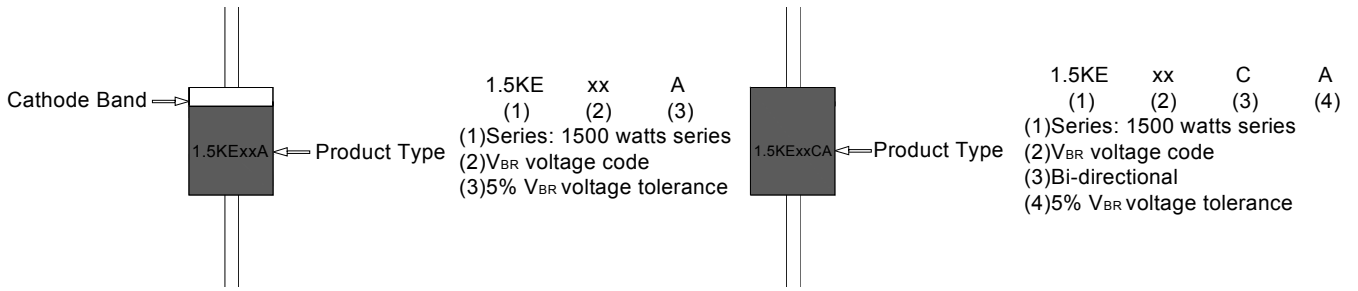

PACKAGE MECHANICAL DATA

Ref.	Dimensions			
	Millimeters		Inches	
	Min.	Max.	Min.	Max.
A	25.40	-	1.000	-
B	7.20	9.60	0.283	0.378
C	0.96	1.07	0.038	0.042
D	4.80	5.40	0.189	0.213

TAPE AND BOX SPECIFICATION-DO-27

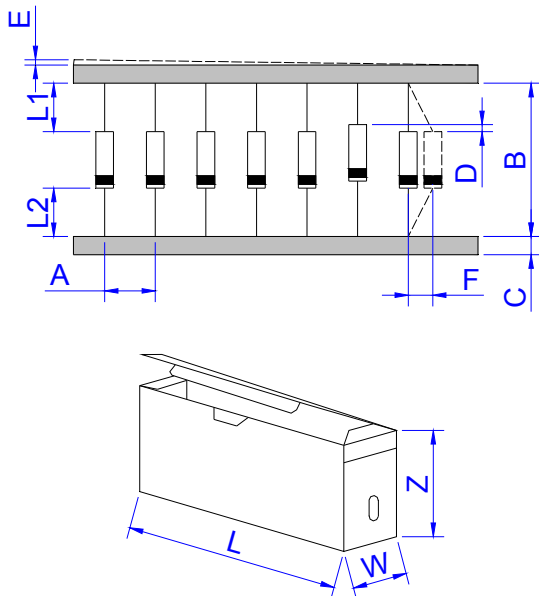

Ref.	Dimensions	
	Millimeters	Inches
A	10.0±0.5	0.394±0.020
B	53.0±1.5	2.087±0.059
C	6.0±0.5	0.236±0.020
D	1.2(MAX)	0.047(MAX)
E	0.8(MAX)	0.031(MAX)
F	1.5(MAX)	0.059(MAX)
L1-L2	1.0(MAX)	0.039(MAX)
W	80±5.0	3.150±0.197
L	250±5.0	9.843±0.197
Z	115±5.0	4.528±0.197

PART No.	UNIT WEIGHT (g/PCS) typ.	PER BOX (PCS)	PER CARTON (PCS)	DESCRIPTION
1.5KExxA/CA	1.11	1,000	10,000	Box

Information furnished in this document is believed to be accurate and reliable. However, Jiangsu JieJie Microelectronics Co.,Ltd assumes no responsibility for the consequences of use without consideration for such information nor use beyond it.

Information mentioned in this document is subject to change without notice, apart from that when an agreement is signed, Jiangsu JieJie complies with the agreement.

Products and information provided in this document have no infringement of patents. Jiangsu JieJie assumes no responsibility for any infringement of other rights of third parties which may result from the use of such products and information.

This document is the 2.6th version which is made in 3-Aug.-2021. This document supersedes and replaces all information previously supplied.

 is a registered trademark of Jiangsu JieJie Microelectronics Co.,Ltd.

Copyright©2021 Jiangsu JieJie Microelectronics Co.,Ltd. Printed All rights reserved.

单击下面可查看定价，库存，交付和生命周期等信息

[>>JW\(捷捷微\)](#)