

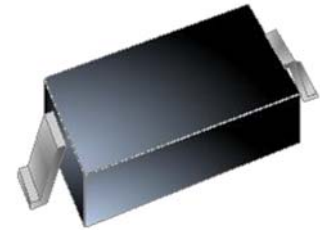

### FEATURES

- ◇ 400 watts peak pulse power per line ( $t_P=8/20\mu s$ )
- ◇ Protects one bi-directional I/O line
- ◇ Low clamping voltage
- ◇ Working voltage: 5V
- ◇ Low leakage current
- ◇ RoHS compliant
- ◇ Meets MSL level 3



SOD-323

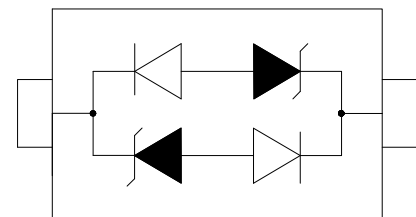

Pin Configuration

### MAIN APPLICATIONS

- ◇ Cell phone handsets and accessories
- ◇ Microprocessor based equipment
- ◇ Personal digital assistants (PDA's)
- ◇ Notebooks, desktops, and servers
- ◇ Portable instrumentation
- ◇ Peripherals
- ◇ USB interface

### PROTECTION SOLUTION TO MEET

- ◇ IEC61000-4-2 (ESD)  $\pm 30kV$  (air),  $\pm 30kV$  (contact)
- ◇ IEC61000-4-4 (EFT) 40A (5/50ns)
- ◇ IEC61000-4-5 (lightning) 17A (8/20 $\mu s$ )

### MECHANICAL CHARACTERISTICS

- ◇ SOD-323 package
- ◇ Molding compound flammability rating: UL 94V-0
- ◇ Weight 5 milligrams (approximate)
- ◇ Quantity per reel: 3,000pcs
- ◇ Lead finish: lead free
- ◇ Marking code:5B

**ABSOLUTE MAXIMUM RATINGS** ( $T_A=25^{\circ}\text{C}$ ,  $\text{RH}=45\%-75\%$ , unless otherwise noted)

Parameter	Symbol	Value	Unit
Peak pulse power dissipation on 8/20 $\mu\text{s}$ waveform	$P_{PP}$	400	W
ESD per IEC 61000-4-2 (Air) ESD per IEC 61000-4-2 (Contact)	$V_{ESD}$	+/- 30 +/- 30	kV
Lead soldering temperature	$T_L$	260 (10 sec.)	$^{\circ}\text{C}$
Operating junction temperature range	$T_J$	-55 to +125	$^{\circ}\text{C}$
Storage temperature range	$T_{STG}$	-55 to +150	$^{\circ}\text{C}$

**ELECTRICAL CHARACTERISTICS** ( $T_A=25^{\circ}\text{C}$ )

Parameter	Symbol	Conditions	Min	Typ	Max	Unit
Reverse working voltage	$V_{RWM}$				5.0	V
Reverse breakdown voltage	$V_{BR}$	$I_T=1\text{mA}$	6.0			V
Reverse leakage current	$I_R$	$V_{RWM}=5\text{V}$			1	$\mu\text{A}$
Clamping voltage	$V_C$	$I_{PP}=1\text{A}$ , $t_P=8/20\mu\text{s}$			9.8	V
		$I_{PP}=17\text{A}$ , $t_P=8/20\mu\text{s}$			25	V
Junction capacitance	$C_J$	$V_{RWM}=0\text{V}$ , $f=1\text{MHz}$		1.0	1.5	pF

**RATINGS AND V-I CHARACTERISTICS CURVES** ( $T_A=25^{\circ}\text{C}$ , unless otherwise noted)

**FIG.1: V- I curve characteristics (Bi-directional)**

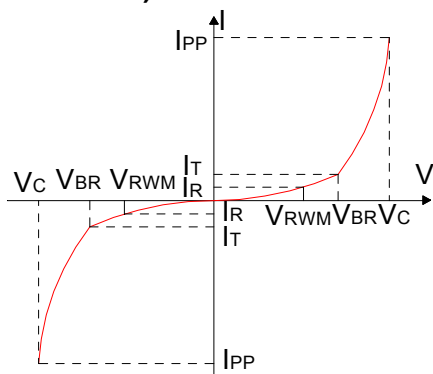

**FIG.2: Pulse waveform (8/20 $\mu\text{s}$ )**

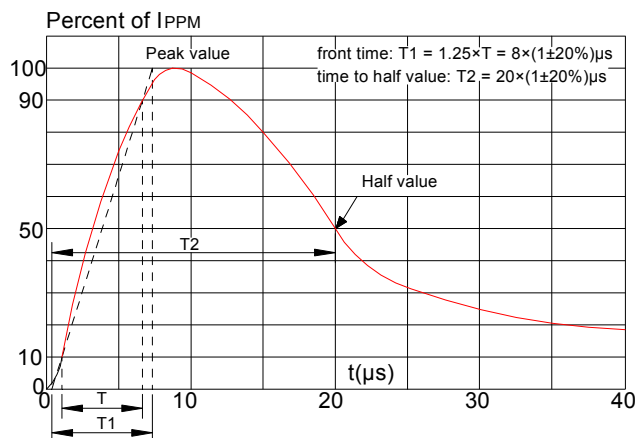

FIG.3: Pulse derating curve

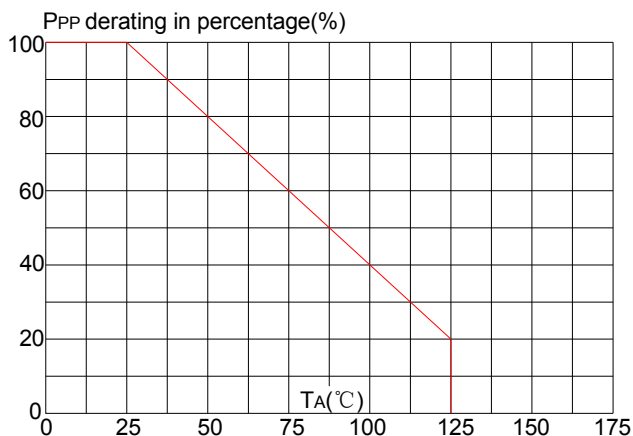
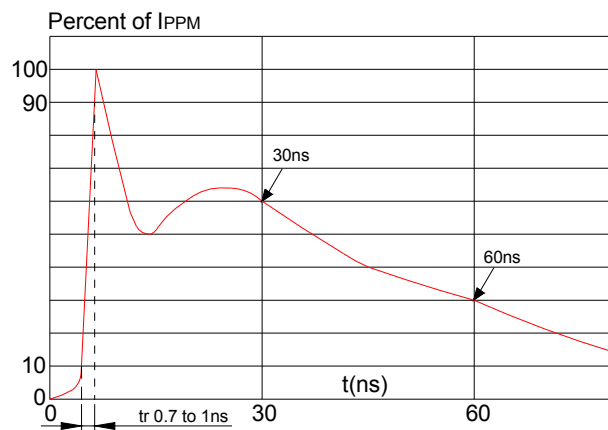
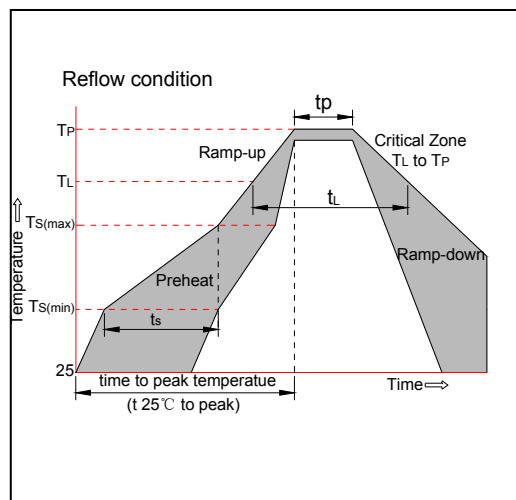

FIG.4: ESD clamping (30kV contact)



SOLDERING PARAMETERS

Reflow Condition		Pb-Free assembly (see figure at right)
Pre Heat	-Temperature Min (Ts(min))	+150°C
	-Temperature Max(Ts(max))	+200°C
	-Time (Min to Max) (ts)	60-180 secs.
Average ramp up rate (Liquidus Temp (TL)to peak)		3°C/sec. Max
Ts(max) to TL - Ramp-up Rate		3°C/sec. Max
Reflow	-Temperature(TL)(Liquidus)	+217°C
	-Temperature(tL)	60-150 secs.
Peak Temp (Tp)		+260(+0/-5)°C
Time within 5°C of actual Peak Temp (tp)		20-40secs.
Ramp-down Rate		6°C/sec. Max
Time 25°C to Peak Temp (Tp)		8 min. Max
Do not exceed		+260°C



**PACKAGE MECHANICAL DATA**

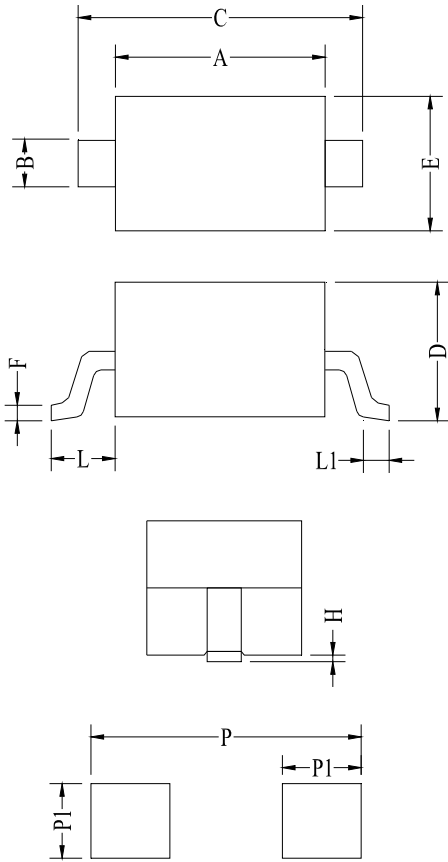

**Land Pattern**

Symbol	Millimeters			Inches		
	Min	Typ	Max	Min	Typ	Max
A	1.60	1.70	1.80	0.063	0.067	0.071
B	0.25	0.32	0.40	0.010	0.013	0.016
C	2.30	2.60	2.80	0.091	0.102	0.110
D	0.80	0.95	1.10	0.031	0.037	0.043
E	1.20	1.30	1.40	0.047	0.051	0.055
F	0.08	0.13	0.18	0.003	0.005	0.007
L	0.475REF			0.019REF		
L1	0.25	0.33	0.40	0.010	0.013	0.016
H	0.00	0.06	0.14	0.000	0.002	0.006
P	3.00			0.118		
P1	0.80			0.031		

TAPE AND REEL INFORMATION-SOD-323

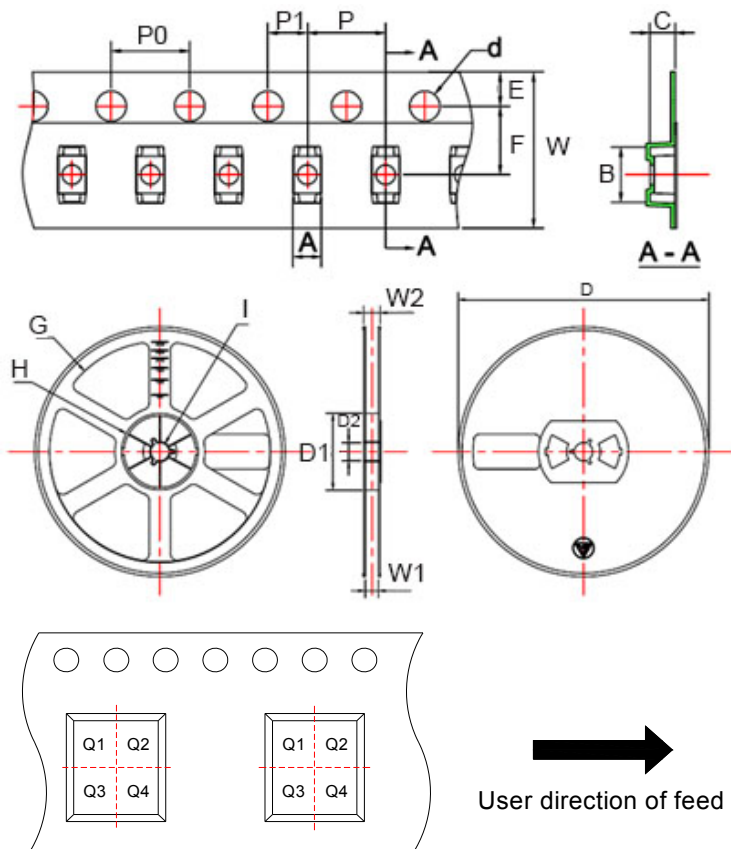

Pin 1 quadrant:Q1&Q2

Packaging description:

SOD-323 parts are shipped in tape. The carrier tape is made from a dissipative(carbon filled) polycarbonate resin. The cover tape is a multilayer film(heat activated adhesive in nature)primarily composed of polyester film, adhesive layer, sealant, and anti-static sprayed agent. The reels are blue in color and made of recyclable plastic.

Symbol	Millimeters	Inches
	Typ	Typ
A	1.46	0.057
B	2.90	0.114
C	1.25	0.049
d	∅1.50	∅0.059
E	1.75	0.069
F	3.50	0.138
P0	4.00	0.157
P	4.00	0.157
P1	2.00	0.079
W	8.00	0.315
D	∅178.0	∅7.008
D1	54.40	2.142
D2	13.00	0.512
G	R78.0	R3.071
H	R25.60	R1.008
I	R6.50	R0.256
W1	9.50	0.374
W2	12.30	0.484

ORDERING INFORMATION

PART No.	PACKAGE TYPE	QUANTITY(PCS) REEL	DESCRIPTION
JEB05C	SOD-323	3,000	7 inch reel pack

**MARKING CODE**

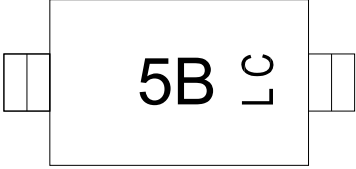
Part Number	Marking Code
JEB05C	

Information furnished in this document is believed to be accurate and reliable. However, Jiangsu JieJie Microelectronics Co.,Ltd assumes no responsibility for the consequences of use without consideration for such information nor use beyond it.

Information mentioned in this document is subject to change without notice, apart from that when an agreement is signed, Jiangsu JieJie complies with the agreement.

Products and information provided in this document have no infringement of patents. Jiangsu JieJie assumes no responsibility for any infringement of other rights of third parties which may result from the use of such products and information.

This document is the second version which is made in 20-May-2021. This document supersedes and replaces all information previously supplied.

 is a registered trademark of Jiangsu JieJie Microelectronics Co.,Ltd.

Copyright ©2021 Jiangsu JieJie Microelectronics Co.,Ltd. Printed All rights reserved.