

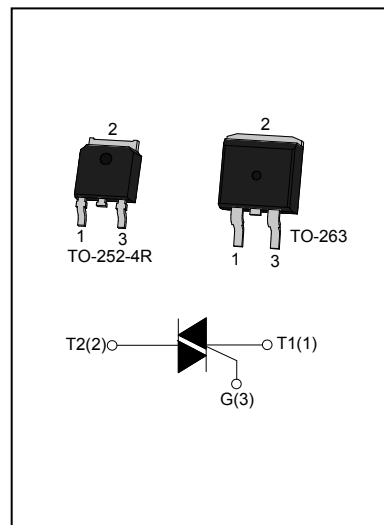

DESCRIPTION:

JST137 series triacs with low holding and latching current are especially recommended for use on middle and small resistance type power load. Package TO-252-4R & TO-263 are RoHS compliant. (2011/65/EU)



MAIN FEATURES

Symbol	Value	Unit
$I_{T(RMS)}$	8	A
V_{DRM}/V_{RRM}	600/800	V

ABSOLUTE MAXIMUM RATINGS

Parameter		Symbol	Value	Unit
Storage junction temperature range		T_{stg}	-40-150	°C
Operating junction temperature range		T_j	-40-125	°C
Repetitive peak off-state voltage($T_j=25^\circ\text{C}$)		V_{DRM}	600/800	V
Repetitive peak reverse voltage($T_j=25^\circ\text{C}$)		V_{RRM}	600/800	V
RMS on-state current	TO-252-4R ($T_c=103^\circ\text{C}$)	$I_{T(RMS)}$	8	A
	TO-263 ($T_c=85^\circ\text{C}$)			
Non repetitive surge peak on-state current (full cycle, F=50Hz)		I_{TSM}	65	A
I^2t value for fusing ($t_p=10\text{ms}$)		I^2t	21	A^2s
Peak gate current		I_{GM}	2	A
Critical rate of rise of on-state current($I_G=2 \times I_{GT}$)	I - II - III	di/dt	50	$\text{A}/\mu\text{s}$
	IV		10	
Average gate power dissipation		$P_{G(AV)}$	0.5	W
Peak gate power		P_{GM}	5	W

ELECTRICAL CHARACTERISTICS ($T_j=25^\circ\text{C}$ unless otherwise specified)

Symbol	Test Condition	Quadrant		Value				Unit
				D	E	F	G	
I_{GT}	$V_D=12\text{V } R_L=30\Omega$	I - II -III	MAX	5	10	25	50	mA
		IV		10	25	70	100	
V_{GT}		ALL	MAX	1.3				V
V_{GD}	$V_D=V_{DRM} T_j=125^\circ\text{C}$ $R_L=3.3\text{K}\Omega$	ALL	MIN	0.2				V
I_L	$I_G=1.2I_{GT}$	I -III	MAX	10	20	50	70	mA
		II -IV		20	30	70	100	
I_H	$I_T=100\text{mA}$		MAX	10	15	40	60	mA
dV/dt	$V_D=2/3V_{DRM}$ Gate Open $T_j=125^\circ\text{C}$		MIN	20	50	50	200	V/ μs

STATIC CHARACTERISTICS

Symbol	Parameter		Value(MAX)	Unit
V_{TM}	$I_{TM}=10\text{A } t_p=380\mu\text{s}$	$T_j=25^\circ\text{C}$	1.6	V
I_{DRM}	$V_D=V_{DRM} V_R=V_{RRM}$	$T_j=25^\circ\text{C}$	5	μA
I_{RRM}		$T_j=125^\circ\text{C}$	1	mA

THERMAL RESISTANCES

Symbol	Parameter		Value	Unit
$R_{th(j-c)}$	junction to case(AC)	TO-252-4R	2.1	$^\circ\text{C/W}$
		TO-263	3.1	
$R_{th(j-a)}$	junction to ambient	TO-252-4R	70	$^\circ\text{C/W}$
		TO-263	45	

ORDERING INFORMATION

<p>JieJie Microelectronics Co.,Ltd</p>	<p>J</p> <p>Triacs</p> <p>ST</p> <p>$I_{T(RMS)}:8A$</p> <p>E:TO-263 ETR:TO-263(Tape&Reel) K:TO-252-4R KTR:TO-252-4R(Tape&Reel)</p>	<p>137</p>	<p>K</p>	<p>-600</p> <p>600:$V_{DRM}/V_{RRM} \geq 600V$ 800:$V_{DRM}/V_{RRM} \geq 800V$</p>	<p>E</p> <p>D:$I_{GT1-3} \leq 5mA$ $I_{GT4} \leq 10mA$ E:$I_{GT1-3} \leq 10mA$ $I_{GT4} \leq 25mA$ F:$I_{GT1-3} \leq 25mA$ $I_{GT4} \leq 70mA$ G:$I_{GT1-3} \leq 50mA$ $I_{GT4} \leq 100mA$</p>
--	---	-------------------	-----------------	---	--

PACKAGE MECHANICAL DATA

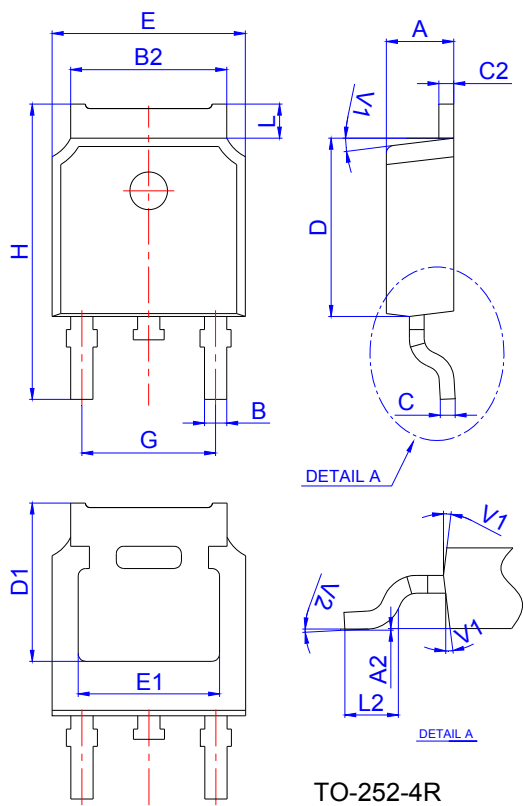

Ref.	Dimensions					
	Millimeters			Inches		
	Min.	Typ.	Max.	Min.	Typ.	Max.
A	2.10		2.50	0.083		0.098
A2	0		0.10	0		0.004
B	0.66		0.86	0.026		0.034
B2	5.18		5.48	0.202		0.216
C	0.40		0.60	0.016		0.024
C2	0.44		0.58	0.017		0.023
D	5.90		6.30	0.232		0.248
D1	5.30REF			0.209REF		
E	6.40		6.80	0.252		0.268
E1	4.63			0.182		
G	4.47		4.67	0.176		0.184
H	9.50		10.70	0.374		0.421
L	1.09		1.21	0.043		0.048
L2	1.35		1.65	0.053		0.065
V1		7°			7°	
V2	0°		6°	0°		6°

FOOTPRINT-TO-252-4R (dimensions in mm)

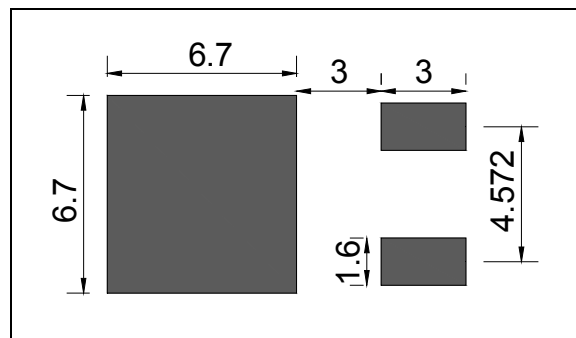

PACKAGE MECHANICAL DATA

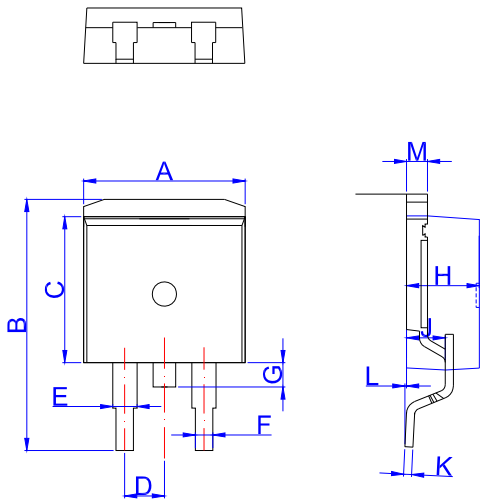

TO-263

Ref.	Dimensions					
	Millimeters			Inches		
	Min.	Typ.	Max.	Min.	Typ.	Max.
A	9.90		10.20	0.390		0.402
B	14.70		15.80	0.579		0.622
C	9.4		9.6	0.37		0.378
D		2.54			0.100	
E	1.20		1.40	0.047		0.055
F	0.75		0.85	0.029		0.033
G			1.75			0.069
H	4.40		4.70	0.173		0.185
J	2.30		2.70	0.091		0.106
K	0.38		0.55	0.015		0.022
L	0	0.10	0.25	0	0.004	0.010
M	1.25		1.35	0.049		0.053

FOOTPRINT-TO-263 (dimensions in mm)

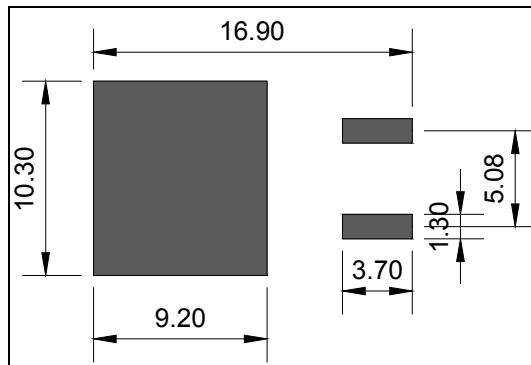

PACKAGE INFORMATION

PACKAGE	OUTLINE	TUBE (PCS)	INNER BOX (PCS)	PER CARTON
TO-263	TUBE	50	1,000	6,000
TO-252-4R	TUBE	80	4,000	32,000
PACKAGE	OUTLINE	REEL (PCS)	PER CARTON (PCS)	TAPE & REEL
TO-263	TAPING	800	4,000	13 inch
TO-252-4R	TAPING	2,500	25,000	13 inch

MARKING

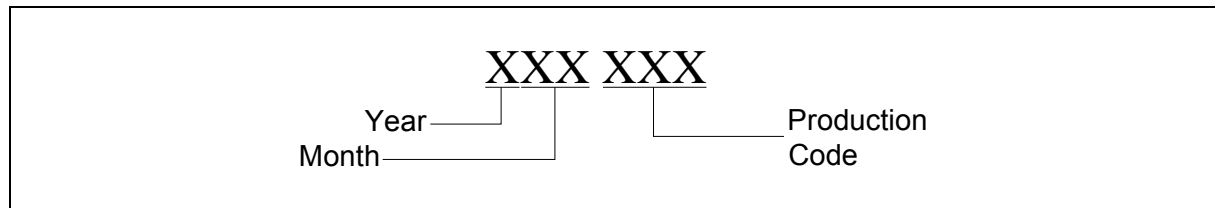
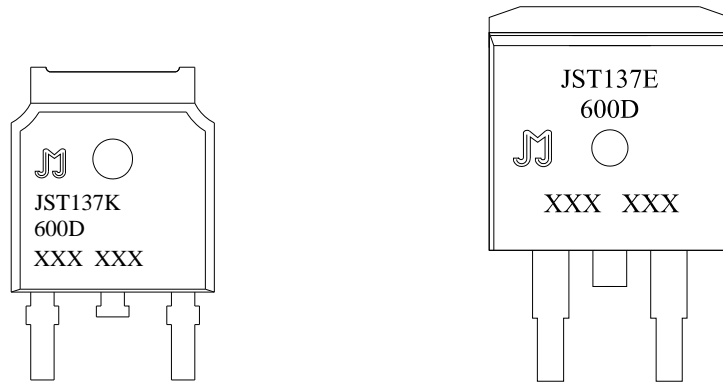

FIG.1: Maximum power dissipation versus RMS on-state current

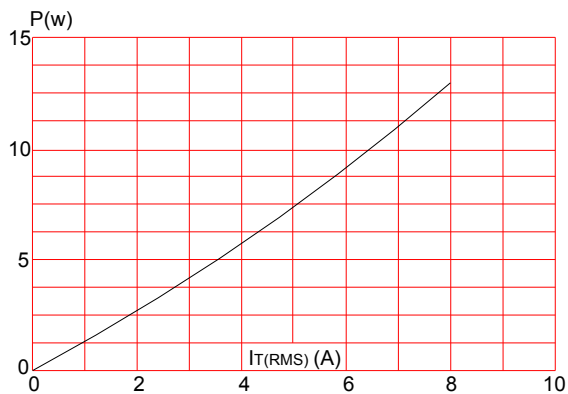

FIG.2: RMS on-state current versus ambient temperature (printed circuit board FR4, copper thickness:35μm)(full cycle)

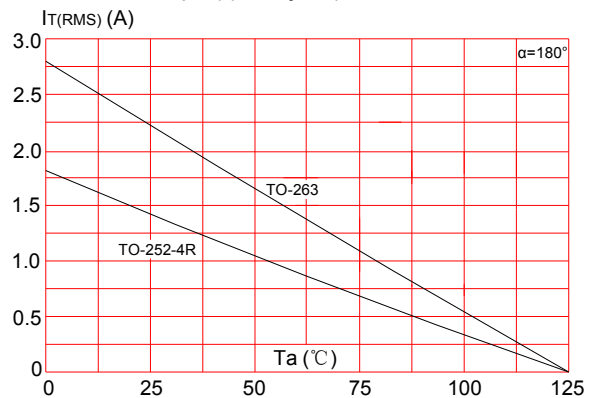

FIG.3: Surge peak on-state current versus number of cycles

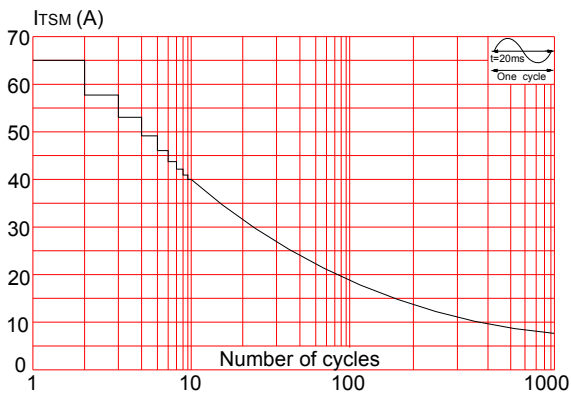

FIG.4: On-state characteristics (maximum values)

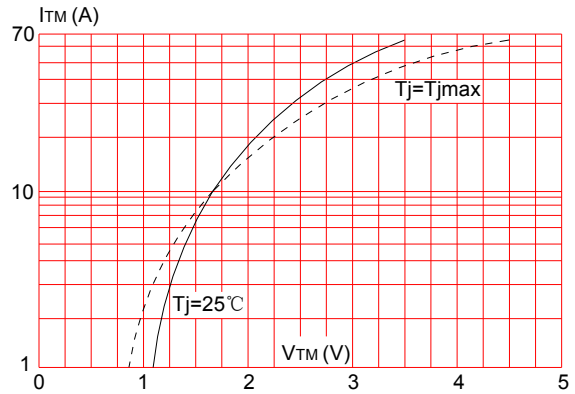

FIG.5: Non-repetitive surge peak on-state current for a sinusoidal pulse with width $t_p < 20\text{ms}$, and corresponding value of I^2t (I - II - III: $dI/dt < 50\text{A}/\mu\text{s}$; IV: $dI/dt < 10\text{A}/\mu\text{s}$)

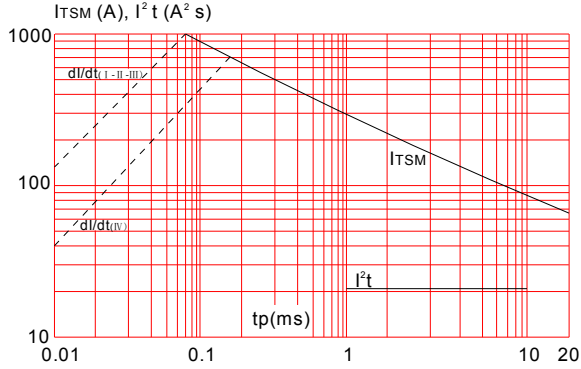

FIG.7: Relative variations of holding current versus junction temperature

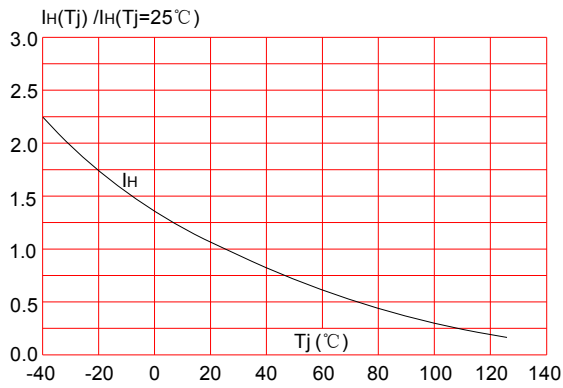

FIG.6: Relative variations of gate trigger current versus junction temperature

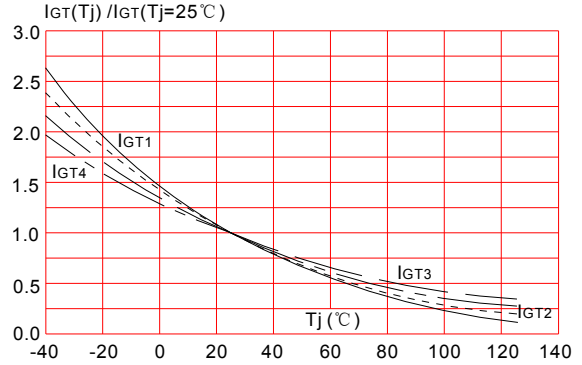
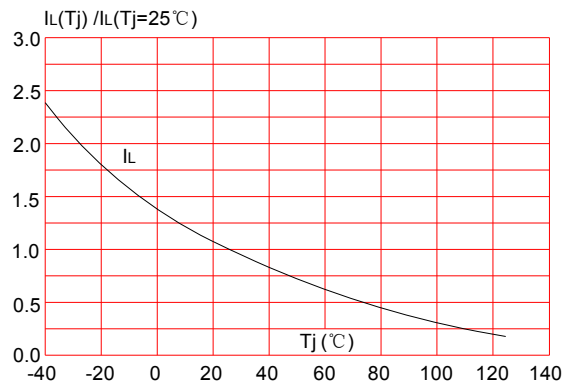
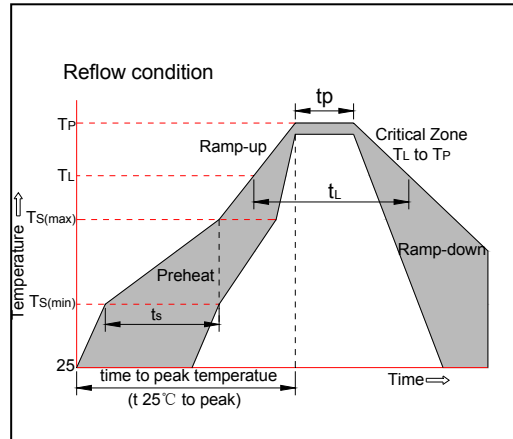

FIG.8: Relative variations of latching current versus junction temperature



SOLDERING PARAMETERS

Reflow Condition		Pb-Free assembly (see figure at right)
Pre Heat	-Temperature Min ($T_{s(min)}$)	+150°C
	-Temperature Max ($T_{s(max)}$)	+200°C
	-Time (Min to Max) (t_s)	60-180 secs.
Average ramp up rate (Liquidus Temp (T_L) to peak)		3°C/sec. Max
$T_{s(max)}$ to T_L - Ramp-up Rate		3°C/sec. Max
Reflow	-Temperature(T_L) (Liquidus)	+217°C
	-Temperature(t_L)	60-150 secs.
Peak Temp (T_p)		+260(+0/-5)°C
Time within 5°C of actual Peak Temp (t_p)		20-40secs.
Ramp-down Rate		6°C/sec. Max
Time 25°C to Peak Temp (T_p)		8 min. Max
Do not exceed		+260°C



Information furnished in this document is believed to be accurate and reliable. However, Jiangsu JieJie Microelectronics Co.,Ltd assumes no responsibility for the consequences of use without consideration for such information nor use beyond it. Information mentioned in this document is subject to change without notice, apart from that when an agreement is signed, Jiangsu JieJie complies with the agreement. Products and information provided in this document have no infringement of patents. Jiangsu JieJie assumes no responsibility for any infringement of other rights of third parties which may result from the use of such products and information. This document is the thirteenth version which is made in 8-Apr.-2019. This document supersedes and replaces all information previously supplied.

 is a registered trademark of Jiangsu JieJie Microelectronics Co.,Ltd.

Copyright ©2019 Jiangsu JieJie Microelectronics Co.,Ltd. Printed All rights reserved.

单击下面可查看定价，库存，交付和生命周期等信息

[>>JW\(捷捷微\)](#)