



P4KE Series 400W Transient Voltage Suppress

Rev.2.3

DESCRIPTION:

The P4KE series of high current uni/bi-directional transient suppressors are designed for A.C. line protection and high power DC bus clamping applications. These devices offer uni/bi-directional port protection from 6.8 volts to 480 volts. They provide a clamping voltage lower than the avalanche voltage. Therefore, any voltage rise due to increased current conduction is contained to a minimum, providing the best possible protection level. They can also be connected in series and/or parallel to create very high capacity protection solutions.

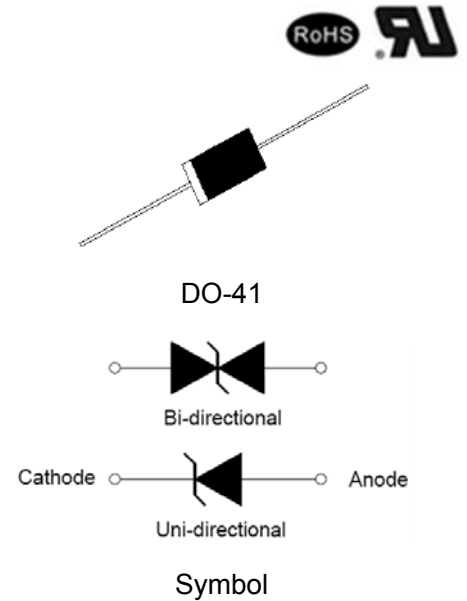

FEATURES

- ✧ Low incremental surge resistance.
- ✧ Excellent clamping capability.
- ✧ DO-41 molded plastic.
- ✧ Color band denoted cathode except bidirectional.
- ✧ High temperature wave soldering: 260°C/10s at terminals.
- ✧ Plastic package has underwriters laboratory flammability 94V-0.
- ✧ 400W peak pulse power capability at 10/1000µs waveform.
- ✧ Meets MSL level 1, per J-STD-020, LF maximum peak of 260°C.
- ✧ Terminal: solder plated, solderable per J-STD-002.
- ✧ Fast response time: typically less than 1.0ps from 0V to V_{BR} min.
- ✧ UL 497B item recognized. (File No.:E480698).
- ✧ IEC61000-4-2 (ESD) ±30kV (air), ±30kV (contact).

ABSOLUTE MAXIMUM RATINGS (T_A=25°C, RH=45%-75%, unless otherwise noted)

Parameter	Symbol	Value	Unit
Operating junction and storage temperature range	T _J , T _{STG}	-55 to +175	°C
Peak pulse power dissipation at 10/1000µs waveform	P _{PP}	400	W
Steady state power dissipation at T _L =75°C	P _{M(AV)}	1.5	W
Maximum instantaneous forward voltage at 25A for unidirectional	V _F	5.0	V
Peak forward surge current, 8.3ms single half sine-wave for unidirectional only(NOTE 1)	I _{FSM}	60	A

ABSOLUTE MAXIMUM RATINGS (T_A=25°C, RH=45%-75%, unless otherwise noted, continued)

Parameter	Symbol	Value	Unit
Typical thermal resistance junction to lead	R _{θJL}	60	°C/W
Typical thermal resistance junction to ambient	R _{θJA}	100	°C/W

Notes:

1. Measured on 8.3ms single half sine wave or equivalent square wave for unidirectional device only, duty cycle=4 per minute maximum

ELECTRICAL CHARACTERISTICS (T_A=25°C)

Part Number		V _R	I _{R@V_R}	V _{BR@I_T}		I _T	V _{C@I_{PP}}	I _{PP} ^①
Uni-Polar	Bi-Polar	V	max(μA)	min(V)	max(V)	mA	max(V)	A
P4KE6.8A	P4KE6.8CA	5.8	150	6.45	7.14	10	10.5	39.0
P4KE7.5A	P4KE7.5CA	6.4	100	7.13	7.88	10	11.3	36.3
P4KE8.2A	P4KE8.2CA	7.02	50	7.79	8.61	10	12.1	33.9
P4KE9.1A	P4KE9.1CA	7.78	20	8.65	9.55	1	13.4	30.6
P4KE10A	P4KE10CA	8.55	10	9.50	10.50	1	14.5	28.3
P4KE11A	P4KE11CA	9.4	5	10.50	11.60	1	15.6	26.3
P4KE12A	P4KE12CA	10.2	2	11.40	12.60	1	16.7	24.6
P4KE13A	P4KE13CA	11.1	1	12.40	13.70	1	18.2	22.5
P4KE15A	P4KE15CA	12.8	1	14.30	15.80	1	21.2	19.3
P4KE16A	P4KE16CA	13.6	1	15.20	16.80	1	22.5	18.2
P4KE18A	P4KE18CA	15.3	1	17.10	18.90	1	25.2	16.1
P4KE20A	P4KE20CA	17.1	1	19.00	21.00	1	27.7	14.8
P4KE22A	P4KE22CA	18.8	1	20.90	23.10	1	30.6	13.4
P4KE24A	P4KE24CA	20.5	1	22.80	25.20	1	33.2	12.3
P4KE27A	P4KE27CA	23.1	1	25.70	28.40	1	37.5	10.9
P4KE30A	P4KE30CA	25.6	1	28.50	31.50	1	41.4	9.9
P4KE33A	P4KE33CA	28.2	1	31.40	34.70	1	45.7	9.0
P4KE36A	P4KE36CA	30.8	1	34.20	37.80	1	49.9	8.2
P4KE39A	P4KE39CA	33.3	1	37.10	41.00	1	53.9	7.6
P4KE43A	P4KE43CA	36.8	1	40.90	45.20	1	59.3	6.9
P4KE47A	P4KE47CA	40.2	1	44.70	49.40	1	64.8	6.3
P4KE51A	P4KE51CA	43.6	1	48.50	53.60	1	70.1	5.8

ELECTRICAL CHARACTERISTICS (T_A=25°C, continued)

Part Number		V _R	I _R @V _R	V _{BR} @I _T		I _T	V _C @I _{PP}	I _{PP} ^①
Uni-Polar	Bi-Polar	V	max(μA)	min(V)	max(V)	mA	max(V)	A
P4KE56A	P4KE56CA	47.8	1	53.20	58.80	1	77.0	5.3
P4KE62A	P4KE62CA	53.0	1	58.90	65.10	1	85.0	4.8
P4KE68A	P4KE68CA	58.1	1	64.60	71.40	1	92.0	4.5
P4KE75A	P4KE75CA	64.1	1	71.30	78.80	1	103.0	4.0
P4KE82A	P4KE82CA	70.1	1	77.90	86.10	1	113.0	3.6
P4KE91A	P4KE91CA	77.8	1	86.50	95.50	1	125.0	3.3
P4KE100A	P4KE100CA	85.5	1	95.00	105.0	1	137.0	3.0
P4KE110A	P4KE110CA	94.0	1	105.0	116.0	1	152.0	2.7
P4KE120A	P4KE120CA	102.0	1	114.0	126.0	1	165.0	2.5
P4KE130A	P4KE130CA	111.0	1	124.0	137.0	1	179.0	2.3
P4KE150A	P4KE150CA	128.0	1	143.0	158.0	1	207.0	2.0
P4KE160A	P4KE160CA	136.0	1	152.0	168.0	1	219.0	1.9
P4KE170A	P4KE170CA	145.0	1	162.0	179.0	1	234.0	1.8
P4KE180A	P4KE180CA	154.0	1	171.0	189.0	1	246.0	1.7
P4KE200A	P4KE200CA	171.0	1	190.0	210.0	1	274.0	1.5
P4KE220A	P4KE220CA	185.0	1	209.0	231.0	1	328.0	1.3
P4KE250A	P4KE250CA	214.0	1	237.0	263.0	1	344.0	1.2
P4KE300A	P4KE300CA	256.0	1	285.0	315.0	1	414.0	1.0
P4KE350A	P4KE350CA	300.0	1	332.0	368.0	1	482.0	0.85
P4KE400A	P4KE400CA	342.0	1	380.0	420.0	1	548.0	0.75
P4KE440A	P4KE440CA	376.0	1	418.0	462.0	1	602.0	0.68
P4KE480A	P4KE480CA	408.0	1	456.0	504.0	1	658.0	0.61

① Surge waveform: 10/1000μs

V_R: Stand-off voltage -- maximum voltage that can be appliedV_{BR}: Breakdown voltageV_C: Clamping voltage -- peak voltage measured across the suppressor at a specified I_{PP}I_R: Reverse leakage current

RATINGS AND V-I CHARACTERISTICS CURVES (T_A=25°C, unless otherwise noted)

FIG.1:V- I curve characteristics (Uni-directional)

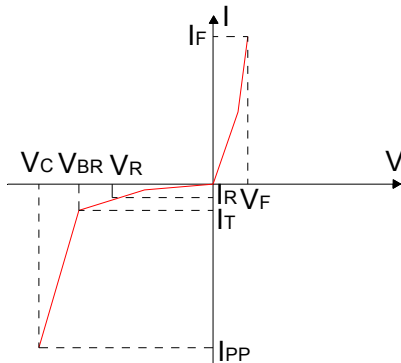

FIG.2:V- I curve characteristics (Bi-directional)

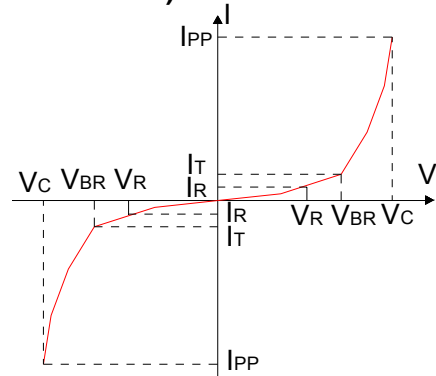

FIG.3: Pulse waveform

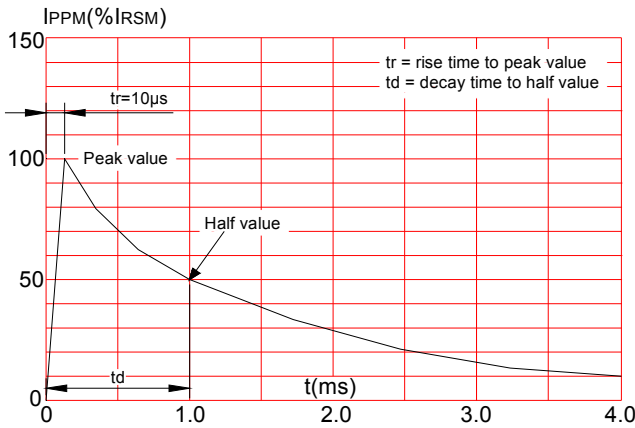
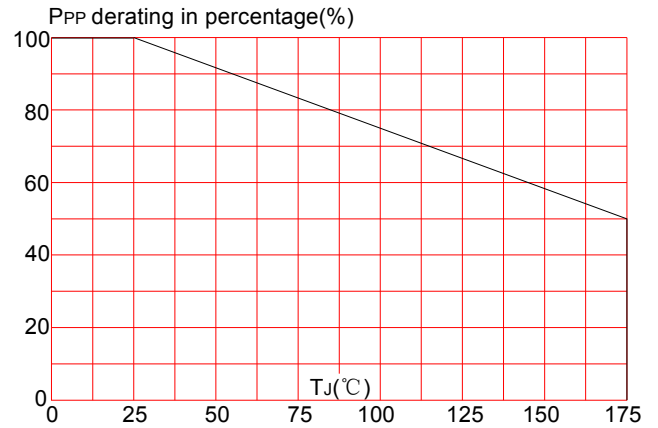
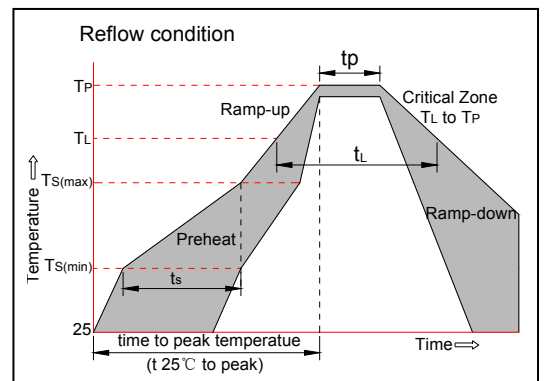

FIG.4: Pulse derating curve



SOLDERING PARAMETERS

Reflow Condition		Pb-Free assembly (see figure at right)
Pre Heat	-Temperature Min (T _{s(min)})	+150°C
	-Temperature Max(T _{s(max)})	+200°C
	-Time (Min to Max) (t _s)	60-180 secs.
Average ramp up rate (Liquidus Temp (T _L)to peak)		3°C/sec. Max
T _{s(max)} to T _L - Ramp-up Rate		3°C/sec. Max
Reflow	-Temperature(T _L)(Liquidus)	+217°C
	-Temperature(t _L)	60-150 secs.
Peak Temp (T _p)		+260(+0/-5)°C
Time within 5°C of actual Peak Temp (t _p)		20-40secs.
Ramp-down Rate		6°C/sec. Max
Time 25°C to Peak Temp (T _p)		8 min. Max
Do not exceed		+260°C



Flow/Wave Soldering(Solder Dipping)	
Peak Temperature	260°C
Dipping Time	10 seconds
Soldering	1 time

MARKING & ORDERING INFORMATION

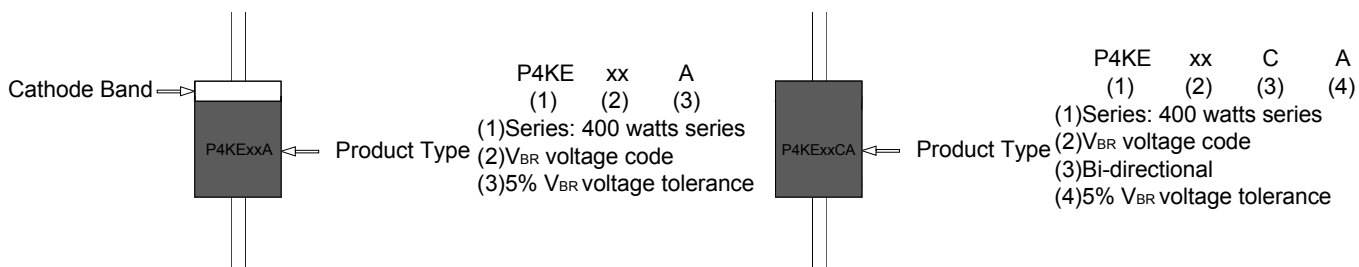

PACKAGE MECHANICAL DATA

Ref.	Dimensions			
	Millimeters		Inches	
	Min.	Max.	Min.	Max.
A	25.40	-	1.000	-
B	4.90	5.30	0.193	0.209
C	0.69	0.89	0.027	0.035
D	2.40	2.80	0.095	0.110

TAPE AND BOX SPECIFICATION-DO-41

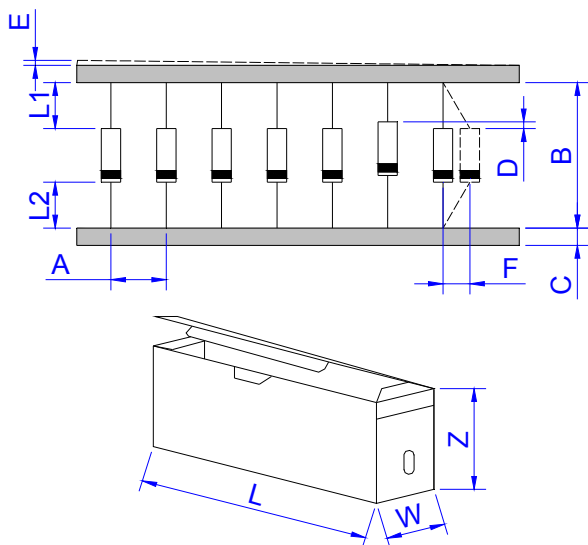

Ref.	Dimensions	
	Millimeters	Inches
A	5.0±0.5	0.197±0.020
B	53.0±1.5	2.087±0.059
C	6.0±0.5	0.236±0.020
D	1.2(MAX)	0.047(MAX)
E	0.8(MAX)	0.031(MAX)
F	1.5(MAX)	0.059(MAX)
L1-L2	1.0(MAX)	0.039(MAX)
W	80±5.0	3.150±0.197
L	255±5.0	10.039±0.197
Z	145±5.0	5.709±0.197

PART No.	UNIT WEIGHT (g/PCS) typ.	PER BOX (PCS)	PER CARTON (PCS)	DESCRIPTION
P4KExxA/CA	0.28	5,000	50,000	Box

Information furnished in this document is believed to be accurate and reliable. However, Jiangsu JieJie Microelectronics Co.,Ltd assumes no responsibility for the consequences of use without consideration for such information nor use beyond it.

Information mentioned in this document is subject to change without notice, apart from that when an agreement is signed, Jiangsu JieJie complies with the agreement.

Products and information provided in this document have no infringement of patents. Jiangsu JieJie assumes no responsibility for any infringement of other rights of third parties which may result from the use of such products and information.

This document is the 2.3rd version which is made in 2-Aug.-2021. This document supersedes and replaces all information previously supplied.

 is a registered trademark of Jiangsu JieJie Microelectronics Co.,Ltd.

Copyright©2021 Jiangsu JieJie Microelectronics Co.,Ltd. Printed All rights reserved.

单击下面可查看定价，库存，交付和生命周期等信息

[>>JW\(捷捷微\)](#)