

60V 1.3mΩ N-Ch Power MOSFET

Features

- Ultra-low ON-resistance, $R_{DS(ON)}$
- Low Gate Charge, Q_g
- 100% UIS and R_g Tested
- Pb-free Lead Plating
- Halogen-free and RoHS-compliant
- AEC-Q101 Qualified for Automotive Applications

Product Summary

| Parameter | Value | Unit |
|--|-------|------|
| V_{DS} | 60 | V |
| $V_{GS(th), Typ}$ | 2.8 | V |
| I_D (@ $V_{GS} = 10V$) ⁽¹⁾ | 225 | A |
| $R_{DS(ON), Typ}$ (@ $V_{GS} = 10V$) | 1.3 | mΩ |

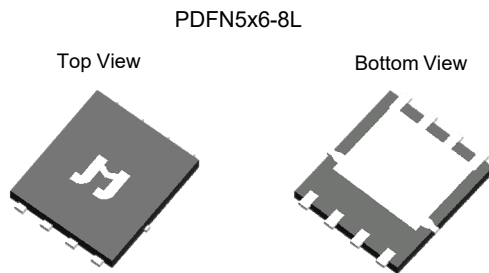
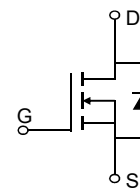
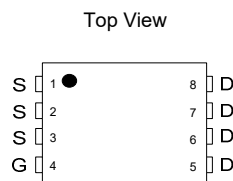
Pin Configuration

Ordering Information

| Device | Package | # of Pins | Marking | MSL | T_J (°C) | Media | Quantity (pcs) |
|----------------|------------|-----------|----------|-----|------------|--------------|----------------|
| JMSH0601AGQ-13 | PDFN5x6-8L | 8 | SH0601AQ | 1 | -55 to 175 | 13-inch Reel | 3000 |

Absolute Maximum Ratings (@ $T_A = 25^\circ\text{C}$ unless otherwise specified)

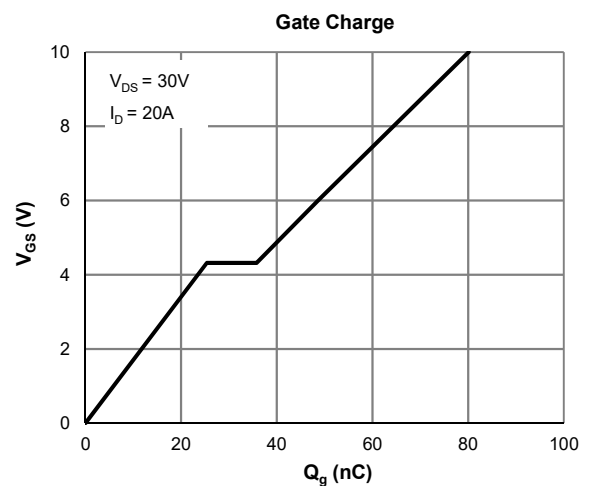
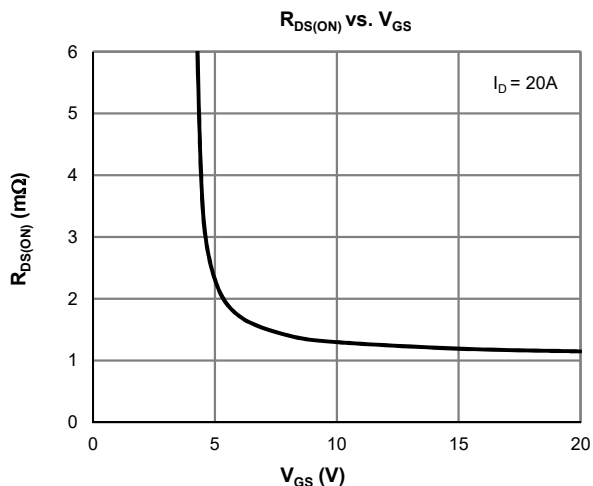
| Parameter | Symbol | Value | Unit |
|---|----------------|---------------------------|------|
| Drain-to-Source Voltage | V_{DS} | 60 | V |
| Gate-to-Source Voltage | V_{GS} | ± 20 | V |
| Continuous Drain Current ⁽¹⁾ | I_D | $T_C = 25^\circ\text{C}$ | 225 |
| | | $T_C = 100^\circ\text{C}$ | 159 |
| Pulsed Drain Current ⁽²⁾ | I_{DM} | 902 | A |
| Avalanche Current ⁽³⁾ | I_{AS} | 50 | A |
| Avalanche Energy ⁽³⁾ | E_{AS} | 375 | mJ |
| Power Dissipation ⁽⁴⁾ | P_D | $T_C = 25^\circ\text{C}$ | 176 |
| | | $T_C = 100^\circ\text{C}$ | 88 |
| Junction & Storage Temperature Range | T_J, T_{STG} | -55 to 175 | °C |





Electrical Characteristics (@ $T_J = 25^\circ\text{C}$ unless otherwise specified)

| Parameter | Symbol | Conditions | Min. | Typ. | Max. | Unit |
|-----------------------------------|---------------|---|------|------|-----------|------------------|
| STATIC PARAMETERS | | | | | | |
| Drain-Source Breakdown Voltage | $V_{(BR)DSS}$ | $I_D = 250\mu\text{A}, V_{GS} = 0\text{V}$ | 60 | | | V |
| Zero Gate Voltage Drain Current | I_{DSS} | $V_{DS} = 48\text{V}, V_{GS} = 0\text{V}$ $T_J = 55^\circ\text{C}$ | | | 1.0 | μA |
| | | | | | 5.0 | |
| Gate-Body Leakage Current | I_{GSS} | $V_{DS} = 0\text{V}, V_{GS} = \pm 20\text{V}$ | | | ± 100 | nA |
| Gate Threshold Voltage | $V_{GS(th)}$ | $V_{DS} = V_{GS}, I_D = 250\mu\text{A}$ | 2.2 | 2.8 | 3.4 | V |
| Static Drain-Source ON-Resistance | $R_{DS(ON)}$ | $V_{GS} = 10\text{V}, I_D = 20\text{A}$ | | 1.3 | 1.7 | $\text{m}\Omega$ |
| Forward Transconductance | g_{FS} | $V_{DS} = 5\text{V}, I_D = 20\text{A}$ | | 435 | | S |
| Diode Forward Voltage | V_{SD} | $I_S = 1\text{A}, V_{GS} = 0\text{V}$ | | 0.65 | 1.0 | V |
| Diode Continuous Current | I_S | $T_C = 25^\circ\text{C}$ | | | 176 | A |

DYNAMIC PARAMETERS ⁽⁵⁾

| | | | | | | |
|------------------------------|-----------|--|---|------|-----|----|
| Input Capacitance | C_{ISS} | $V_{GS} = 0\text{V}, V_{DS} = 30\text{V}, f = 1\text{MHz}$ | | 5874 | | pF |
| Output Capacitance | C_{OSS} | | | 1375 | | pF |
| Reverse Transfer Capacitance | C_{RSS} | | | 45 | | pF |
| Gate Resistance | R_g | | $V_{GS} = 0\text{V}, V_{DS} = 0\text{V}, f = 1\text{MHz}$ | | 2.0 | |

SWITCHING PARAMETERS ⁽⁵⁾

| | | | | | | |
|---|--------------|--|---|------|----|----|
| Total Gate Charge (@ $V_{GS} = 10\text{V}$) | Q_g | $V_{GS} = 0 \text{ to } 10\text{V}$ $V_{DS} = 30\text{V}, I_D = 20\text{A}$ | | 81 | | nC |
| Total Gate Charge (@ $V_{GS} = 6.0\text{V}$) | Q_g | | | 49 | | nC |
| Gate Source Charge | Q_{gs} | | | 25 | | nC |
| Gate Drain Charge | Q_{gd} | | | 10.4 | | nC |
| Turn-On DelayTime | $t_{D(on)}$ | $V_{GS} = 10\text{V}, V_{DS} = 30\text{V}$ $R_L = 1.5\Omega, R_{GEN} = 6\Omega$ | | 17.7 | | ns |
| Turn-On Rise Time | t_r | | | 37 | | ns |
| Turn-Off DelayTime | $t_{D(off)}$ | | | 74 | | ns |
| Turn-Off Fall Time | t_f | | | 37 | | ns |
| Body Diode Reverse Recovery Time | t_{rr} | | $I_F = 20\text{A}, dI_F/dt = 100\text{A}/\mu\text{s}$ | | 63 | |
| Body Diode Reverse Recovery Charge | Q_{rr} | $I_F = 20\text{A}, dI_F/dt = 100\text{A}/\mu\text{s}$ | | 83 | | nC |

Thermal Performance

| Parameter | Symbol | Typ. | Max. | Unit |
|---|-----------------|------|------|---------------------------|
| Thermal Resistance, Junction-to-Ambient | $R_{\theta JA}$ | 42 | 50 | $^\circ\text{C}/\text{W}$ |
| Thermal Resistance, Junction-to-Case | $R_{\theta JC}$ | 0.85 | 1.0 | $^\circ\text{C}/\text{W}$ |

Notes:

1. Computed continuous current assumes the condition of T_{J_Max} while the actual continuous current depends on the thermal & electro-mechanical application board design.
2. This single-pulse measurement was taken under $T_{J_Max} = 175^\circ\text{C}$.
3. This single-pulse measurement was taken under the following condition [$L = 300\mu\text{H}, V_{GS} = 10\text{V}, V_{DD} = 30\text{V}$] while its value is limited by $T_{J_Max} = 175^\circ\text{C}$.
4. The power dissipation P_D is based on $T_{J_Max} = 175^\circ\text{C}$.
5. This value is guaranteed by design hence it is not included in the production test.

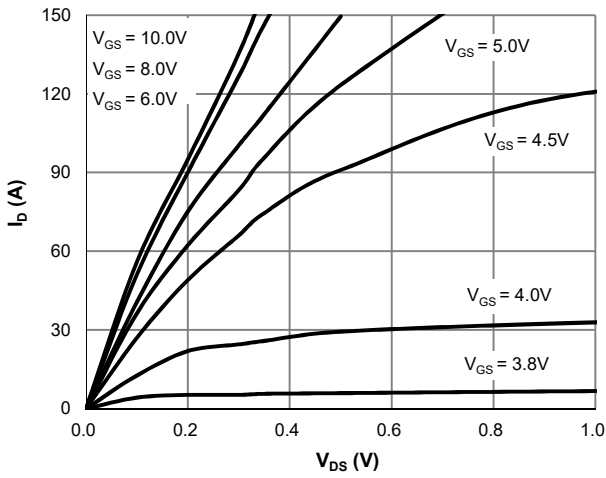
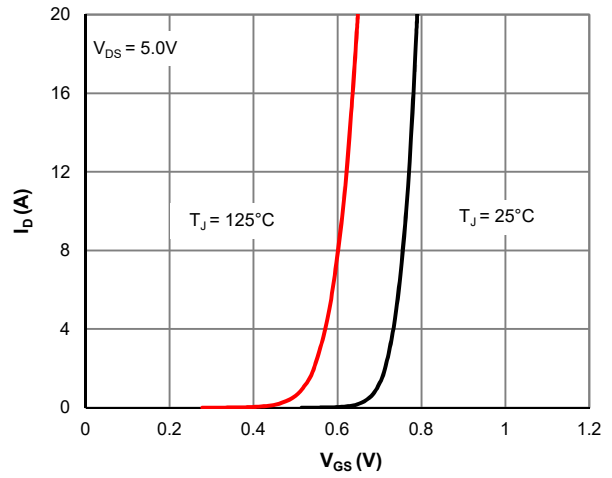
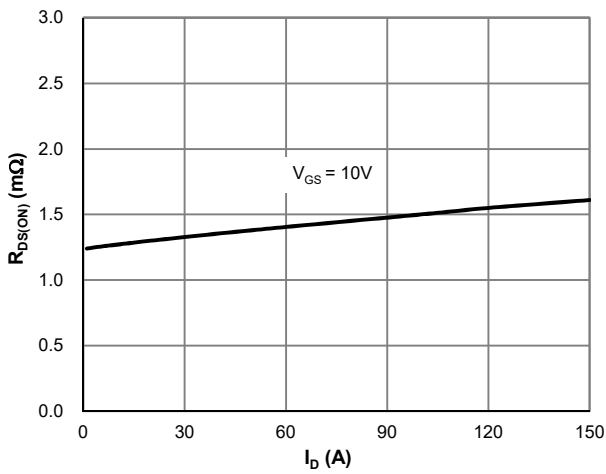
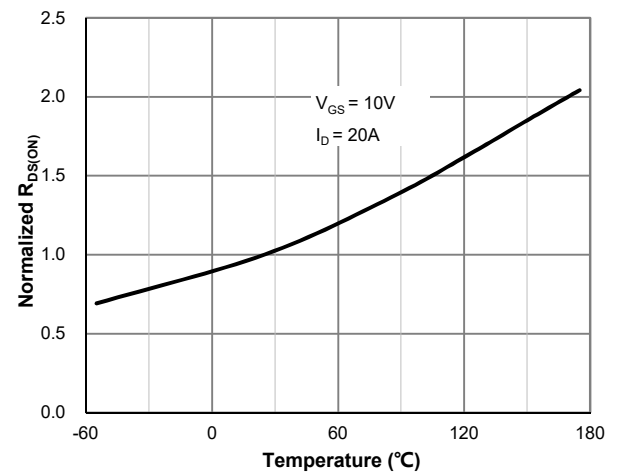
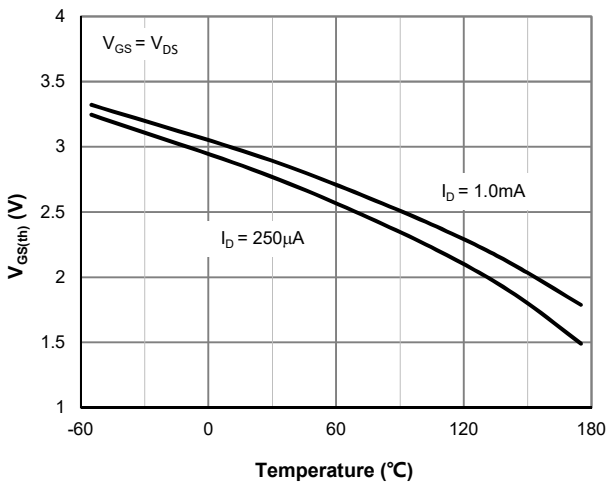
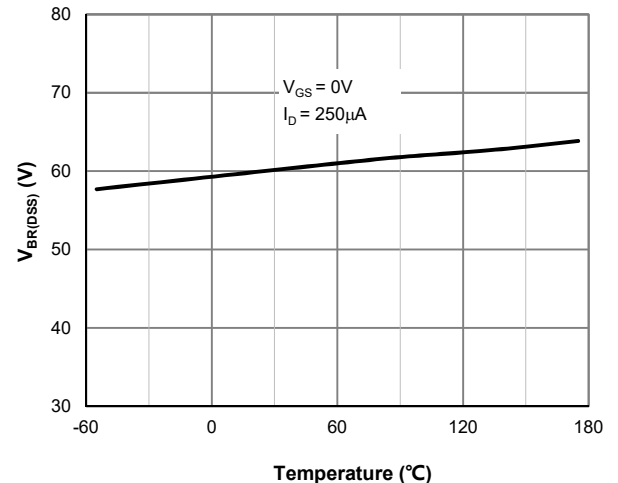
Typical Electrical & Thermal Characteristics

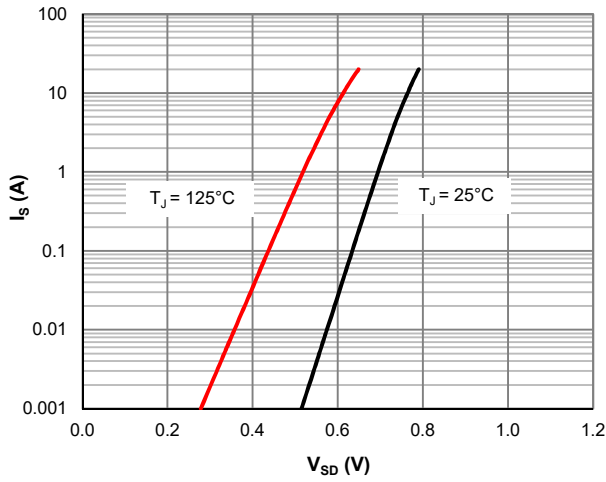
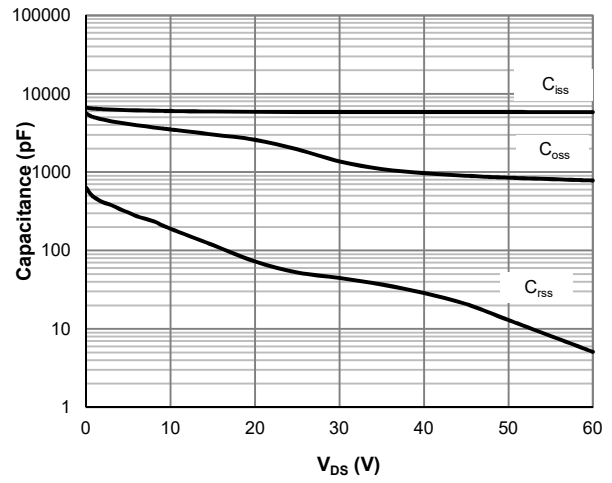
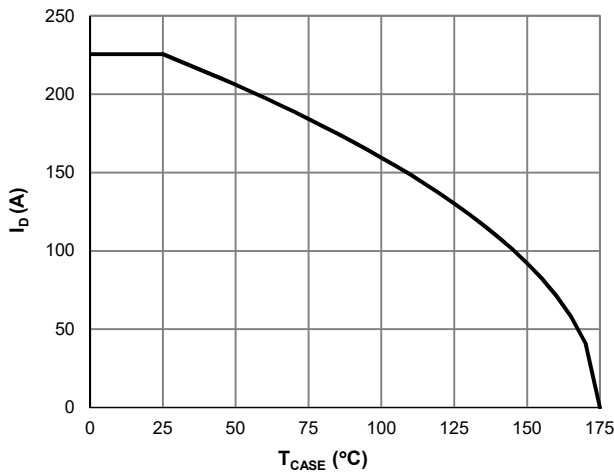
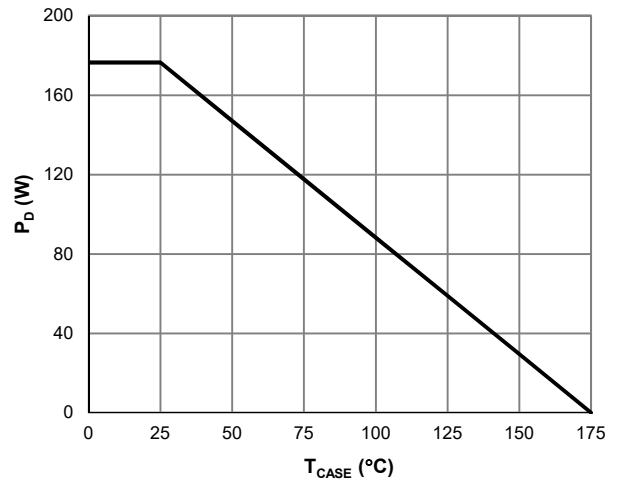
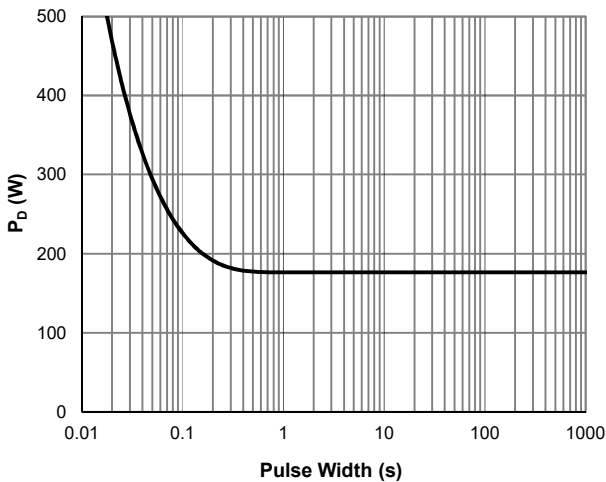
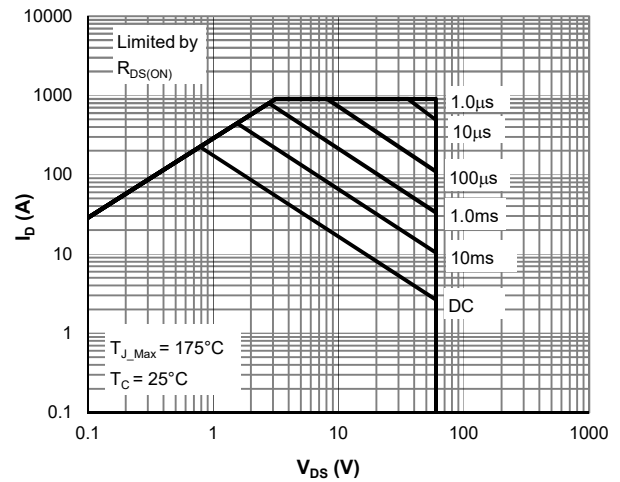
Figure 1: Saturation Characteristics

Figure 2: Transfer Characteristics

Figure 3: $R_{DS(ON)}$ vs. Drain Current

Figure 4: $R_{DS(ON)}$ vs. Junction Temperature

Figure 5: $V_{GS(th)}$ vs. Junction Temperature

Figure 6: $V_{BR(DSS)}$ vs. Junction Temperature

Typical Electrical & Thermal Characteristics

Figure 7: Body-Diode Characteristics

Figure 8: Capacitance Characteristics

Figure 9: Current De-rating

Figure 10: Power De-rating

Figure 11: Single Pulse Power Rating, Junction-to-Case

Figure 12: Maximum Safe Operating Area



Typical Electrical & Thermal Characteristics

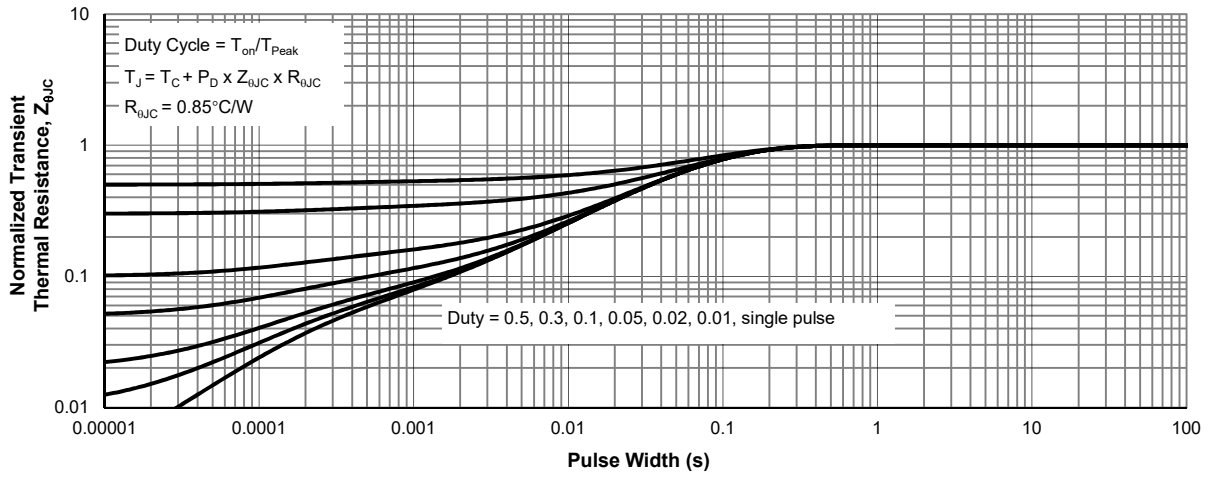
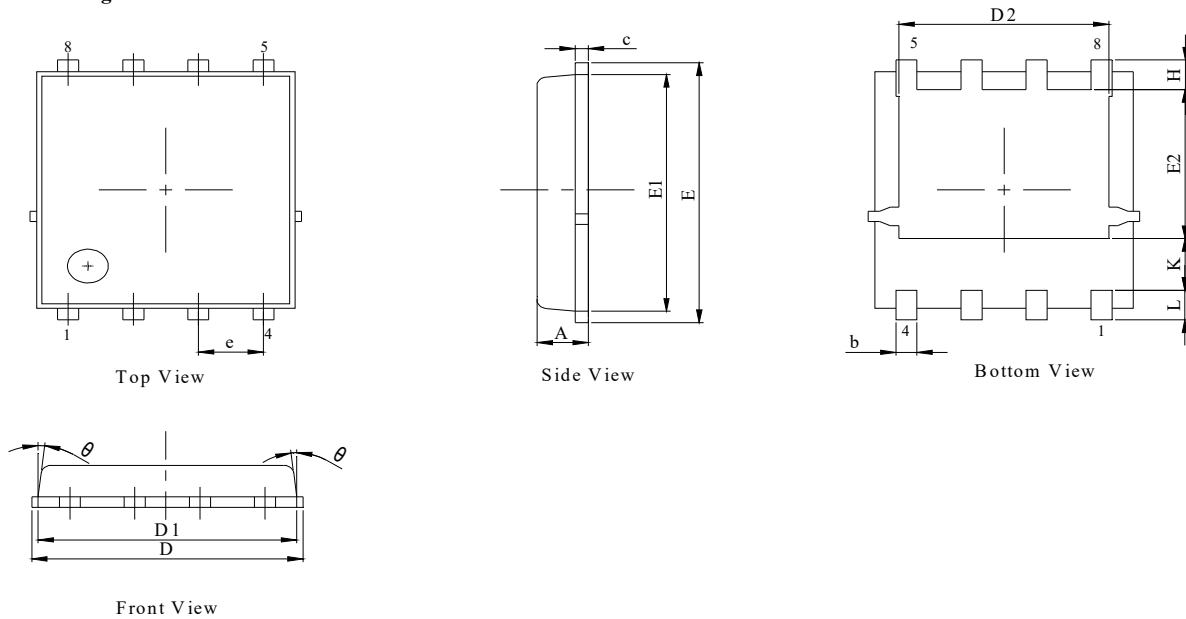
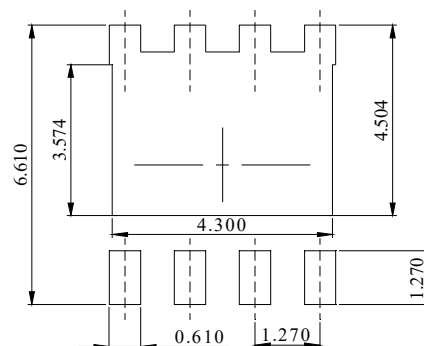

Figure 13: Normalized Maximum Transient Thermal Impedance

PDFN5x6-8L Package Information
Package Outline

NOTES:

1. Dimension and tolerance per ASME Y14.5M, 1994.
2. All dimensions in millimeter (angle in degree).
3. Dimensions D1 and E1 do not include mold flash protrusions or gate burrs.

| DIM. | MILLIMETER | | |
|------|------------|------|------|
| | MIN. | NOM. | MAX. |
| A | 0.90 | 1.00 | 1.10 |
| b | 0.31 | 0.41 | 0.51 |
| c | 0.20 | 0.25 | 0.30 |
| D | 5.00 | 5.20 | 5.40 |
| D1 | 4.95 | 5.05 | 5.15 |
| D2 | 4.00 | 4.10 | 4.20 |
| E | 6.05 | 6.15 | 6.25 |
| E1 | 5.50 | 5.60 | 5.70 |
| E2 | 3.42 | 3.53 | 3.63 |
| e | 1.27BSC | | |
| H | 0.60 | 0.70 | 0.80 |
| L | 0.50 | 0.70 | 0.80 |
| K | 1.23 REF | | |
| θ | - | - | 10° |

Recommended Soldering Footprint

DIMENSIONS: MILLIMETERS

单击下面可查看定价，库存，交付和生命周期等信息

[>>JW\(捷捷微\)](#)