



# 60V 7.4mΩ N-Ch Power MOSFET

### Features

- Low  $R_{DS(ON)}$
- Low Gate Charge
- 100% UIS Tested, 100%  $R_g$  Tested
- Pb-free Lead Plating
- Halogen-free and RoHS-compliant

### Product Summary

Parameter	Value	Unit
$V_{DS}$	60	V
$V_{GS(th\_Typ)}$	1.6	V
$I_D$ (@ $V_{GS} = 10V$ ) <sup>(1)</sup>	56	A
$R_{DS(ON\_Typ)}$ (@ $V_{GS} = 10V$ )	7.4	mΩ
$R_{DS(ON\_Typ)}$ (@ $V_{GS} = 4.5V$ )	9.5	mΩ

### Applications

- Power Management in Telecom., Industrial Automation, CE
- Motor Driving in Power Tool, E-vehicle, Robotics
- Current Switching in DC/DC & AC/DC (SR) Sub-systems

TO-252-3L Top View

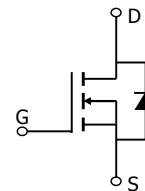

### Ordering Information

Device	Package	# of Pins	Marking	MSL	$T_J$ (°C)	Media	Quantity (pcs)
JMSL0609AK-13	TO-252-3L	3	SL0609A	1	-55 to 150	13-inch Reel	2500

### Absolute Maximum Ratings (@ $T_A = 25^\circ C$ unless otherwise specified)

Parameter	Symbol	Value	Unit
Drain-to-Source Voltage	$V_{DS}$	60	V
Gate-to-Source Voltage	$V_{GS}$	$\pm 20$	V
Continuous Drain Current <sup>(1)</sup>	$I_D$	$T_C = 25^\circ C$	56
		$T_C = 100^\circ C$	34
Pulsed Drain Current <sup>(2)</sup>	$I_{DM}$	224	A
Avalanche Energy <sup>(3)</sup>	$E_{AS}$	74	mJ
Power Dissipation <sup>(4)</sup>	$P_D$	$T_C = 25^\circ C$	52
		$T_C = 100^\circ C$	20
Junction & Storage Temperature Range	$T_J, T_{STG}$	-55 to 150	°C

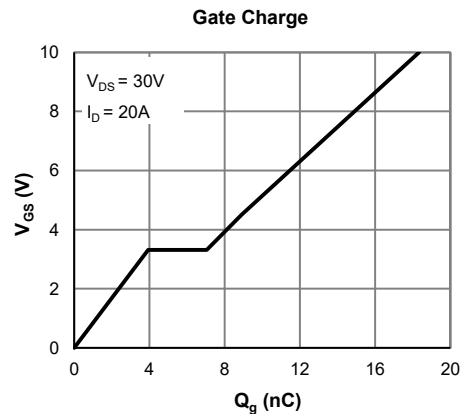
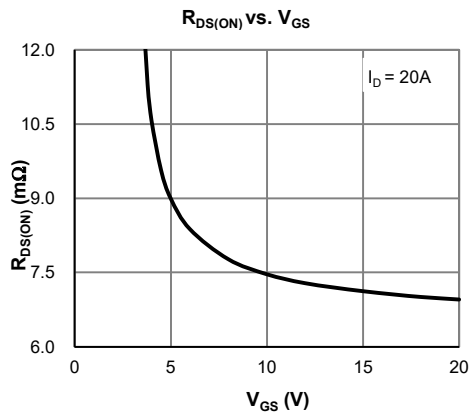

**Electrical Characteristics** (@  $T_J = 25^\circ\text{C}$  unless otherwise specified)

Parameter	Symbol	Conditions	Min.	Typ.	Max.	Unit
<b>STATIC PARAMETERS</b>						
Drain-Source Breakdown Voltage	$V_{(BR)DSS}$	$I_D = 250\mu\text{A}$ , $V_{GS} = 0\text{V}$	60			V
Zero Gate Voltage Drain Current	$I_{DSS}$	$V_{DS} = 48\text{V}$ , $V_{GS} = 0\text{V}$ $T_J = 55^\circ\text{C}$			1.0 5.0	$\mu\text{A}$
Gate-Body Leakage Current	$I_{GSS}$	$V_{DS} = 0\text{V}$ , $V_{GS} = \pm 20\text{V}$			$\pm 100$	nA
Gate Threshold Voltage	$V_{GS(th)}$	$V_{DS} = V_{GS}$ , $I_D = 250\mu\text{A}$	1.2	1.6	2.5	V
Static Drain-Source ON-Resistance	$R_{DS(on)}$	$V_{GS} = 10\text{V}$ , $I_D = 20\text{A}$		7.4	9.4	$\text{m}\Omega$
		$V_{GS} = 4.5\text{V}$ , $I_D = 15\text{A}$		9.5	12.4	$\text{m}\Omega$
Forward Transconductance	$g_{FS}$	$V_{DS} = 5\text{V}$ , $I_D = 20\text{A}$		25		S
Diode Forward Voltage	$V_{SD}$	$I_S = 1\text{A}$ , $V_{GS} = 0\text{V}$		0.70	1.0	V
Diode Continuous Current	$I_S$	$T_C = 25^\circ\text{C}$			52	A

**DYNAMIC PARAMETERS** <sup>(5)</sup>

Input Capacitance	$C_{iss}$	$V_{GS} = 0\text{V}$ , $V_{DS} = 30\text{V}$ , $f = 1\text{MHz}$		1110		pF
Output Capacitance	$C_{oss}$			352		pF
Reverse Transfer Capacitance	$C_{rss}$			12.0		pF
Gate Resistance	$R_g$	$V_{GS} = 0\text{V}$ , $V_{DS} = 0\text{V}$ , $f = 1\text{MHz}$		1.3		$\Omega$

**SWITCHING PARAMETERS** <sup>(5)</sup>

Total Gate Charge (@ $V_{GS} = 10\text{V}$ )	$Q_g$	$V_{GS} = 0$ to $10\text{V}$ $V_{DS} = 30\text{V}$ , $I_D = 20\text{A}$		18.3		nC
Total Gate Charge (@ $V_{GS} = 4.5\text{V}$ )	$Q_g$			8.9		nC
Gate Source Charge	$Q_{gs}$			3.9		nC
Gate Drain Charge	$Q_{gd}$			3.1		nC
Turn-On DelayTime	$t_{D(on)}$			7.0		ns
Turn-On Rise Time	$t_r$	$V_{GS} = 10\text{V}$ , $V_{DS} = 30\text{V}$		19.3		ns
Turn-Off DelayTime	$t_{D(off)}$	$R_L = 1.5\Omega$ , $R_{GEN} = 3\Omega$		18.9		ns
Turn-Off Fall Time	$t_f$			3.4		ns
Body Diode Reverse Recovery Time	$t_{rr}$	$I_F = 20\text{A}$ , $dI_F/dt = 100\text{A}/\mu\text{s}$		21		ns
Body Diode Reverse Recovery Charge	$Q_{rr}$	$I_F = 20\text{A}$ , $dI_F/dt = 100\text{A}/\mu\text{s}$		5.2		nC

**Thermal Performance**

Parameter	Symbol	Typ.	Max.	Unit
Thermal Resistance, Junction-to-Ambient	$R_{\theta JA}$	46	53	$^\circ\text{C}/\text{W}$
Thermal Resistance, Junction-to-Case	$R_{\theta JC}$	2.4	2.8	$^\circ\text{C}/\text{W}$

**Notes:**

1. Computed continuous current assumes the condition of  $T_{J\_Max}$  while the actual continuous current depends on the thermal & electro-mechanical application board design.
2. This single-pulse measurement was taken under  $T_{J\_Max} = 150^\circ\text{C}$ .
3.  $E_{AS}$  of 74 mJ is based on starting  $T_J = 25^\circ\text{C}$ ,  $L = 3.0\text{mH}$ ,  $I_{AS} = 7\text{A}$ ,  $V_{GS} = 10\text{V}$ ,  $V_{DD} = 30\text{V}$ ; 100% test at  $L = 0.1\text{mH}$ ,  $I_{AS} = 26\text{A}$ .
4. The power dissipation  $P_D$  is based on  $T_{J\_Max} = 150^\circ\text{C}$ .
5. This value is guaranteed by design hence it is not included in the production test.

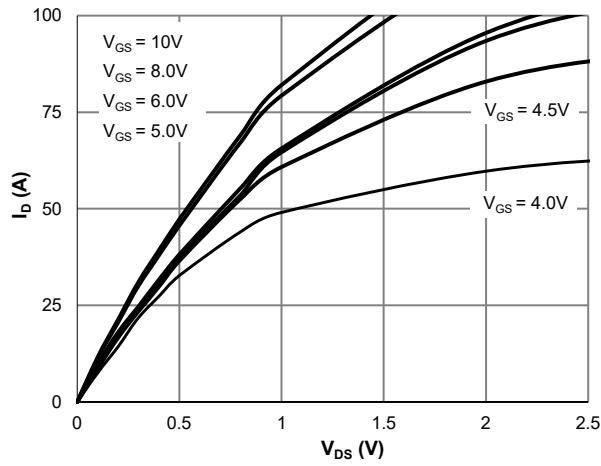
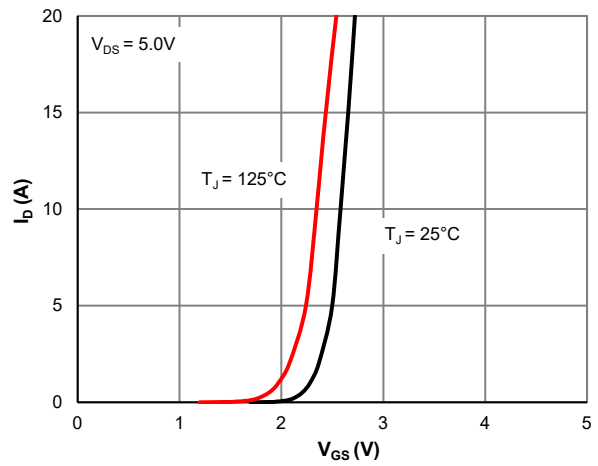
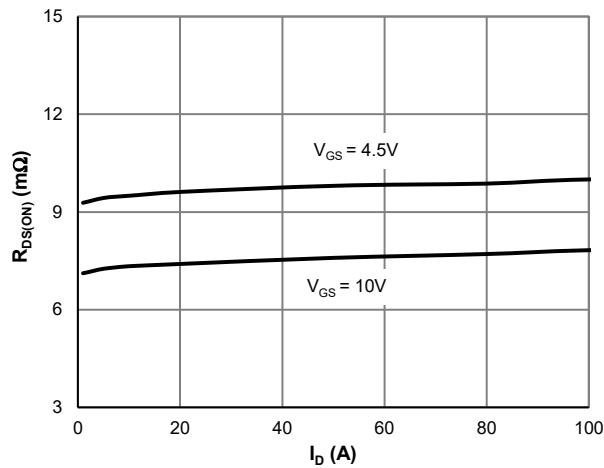
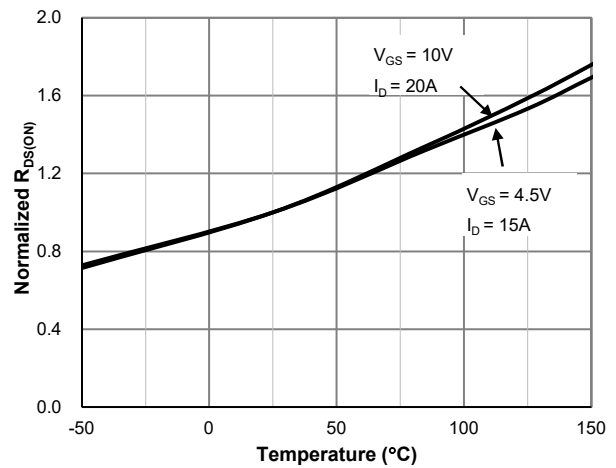
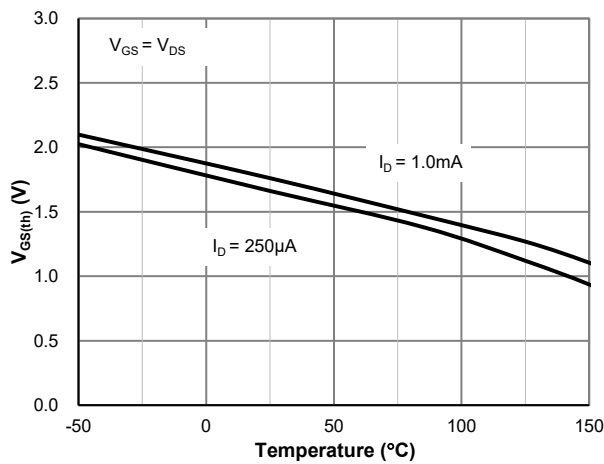
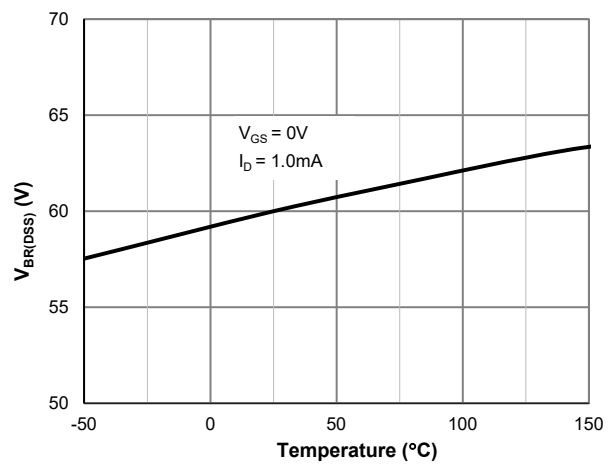
**Typical Electrical & Thermal Characteristics**

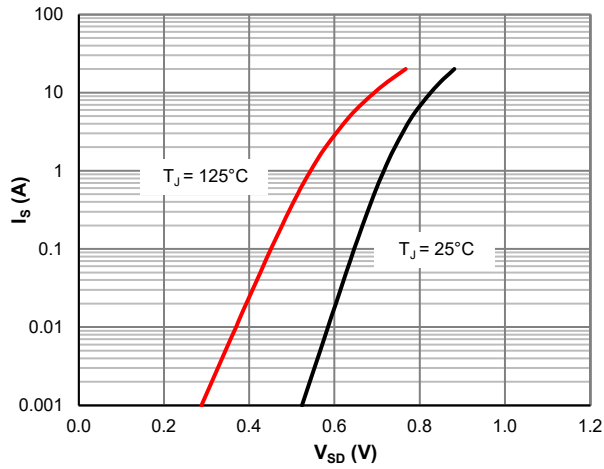
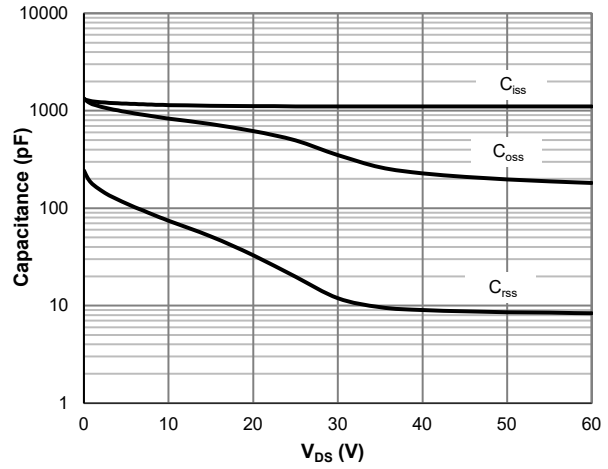
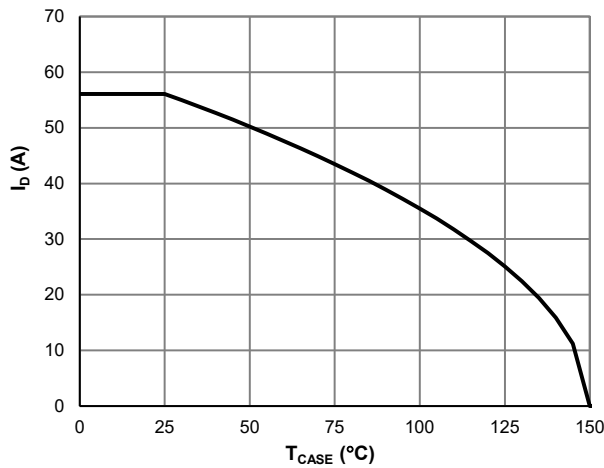
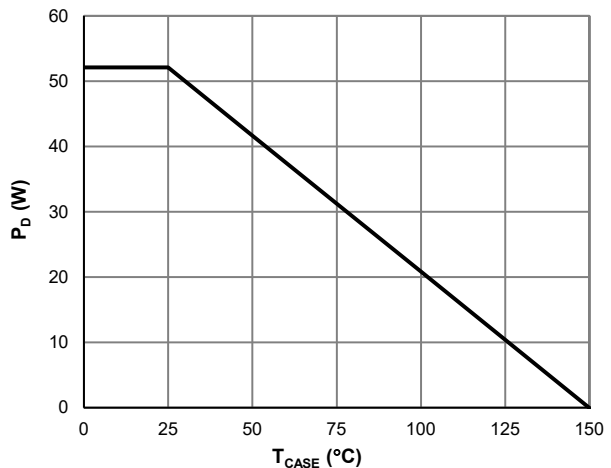
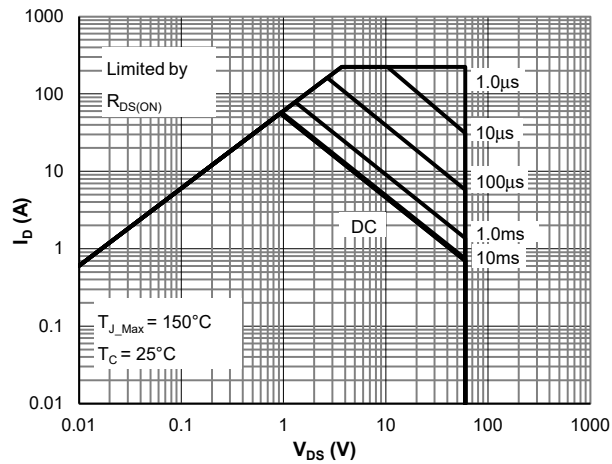
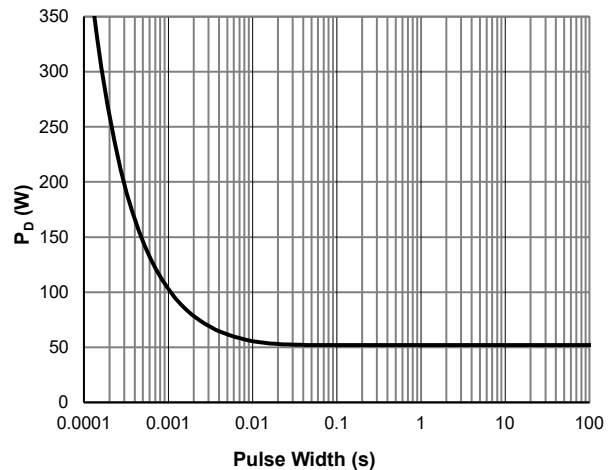
**Figure 1: Saturation Characteristics**

**Figure 2: Transfer Characteristics**

**Figure 3:  $R_{DS(ON)}$  vs. Drain Current**

**Figure 4:  $R_{DS(ON)}$  vs. Junction Temperature**

**Figure 5:  $V_{GS(th)}$  vs. Junction Temperature**

**Figure 6:  $V_{BR(DSS)}$  vs. Junction Temperature**

**Typical Electrical & Thermal Characteristics**

**Figure 7: Body-Diode Characteristics**

**Figure 8: Capacitance Characteristics**

**Figure 9: Current De-rating**

**Figure 10: Power De-rating**

**Figure 11: Maximum Safe Operating Area**

**Figure 12: Single Pulse Power Rating, Junction-to-Case**

Typical Electrical & Thermal Characteristics

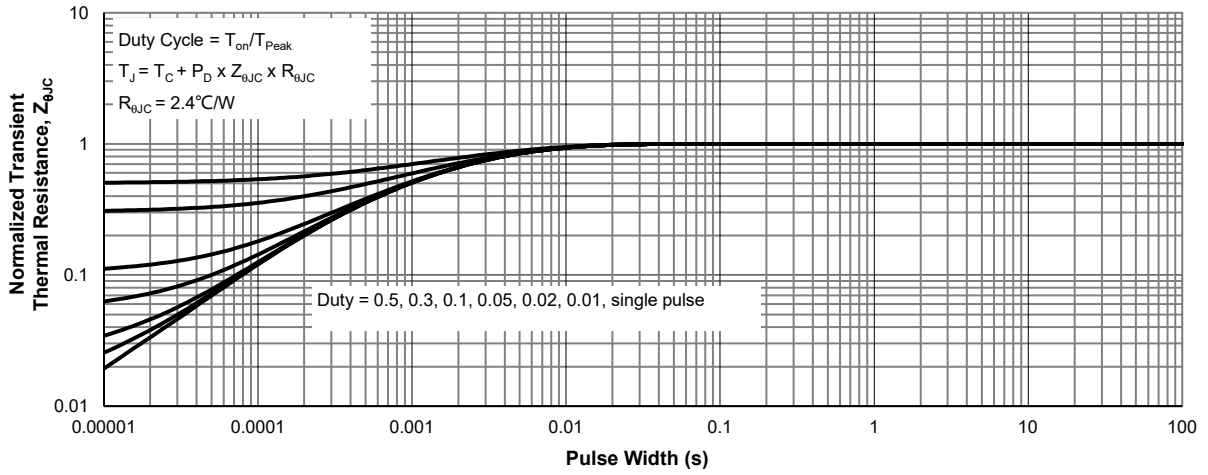
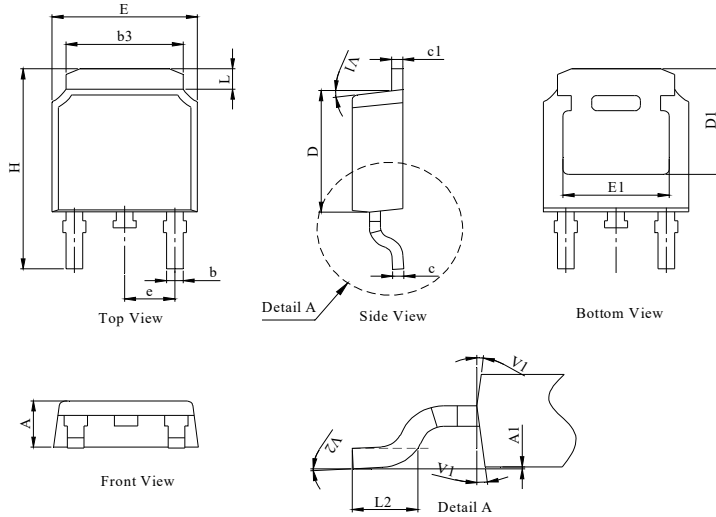
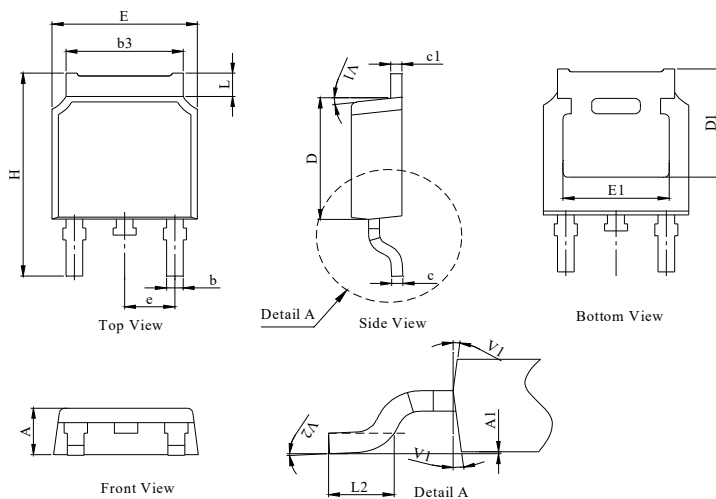

Figure 13: Normalized Maximum Transient Thermal Impedance

**TO-252-3L Package Information**
**Package Outline Type-A**

DIM.	MILLIMETER		
	MIN.	NOM.	MAX.
A	2.18	2.30	2.39
A1	0	--	0.13
b	0.64	0.76	0.89
c	0.40	0.50	0.61
c1	0.46	0.50	0.58
D	5.97	6.10	6.23
D1	5.05	--	--
E	6.35	6.60	6.73
E1	4.32	--	--
b3	5.21	5.38	5.55
e	2.29 BSC		
H	9.40	10.00	10.40
L	0.89	--	1.27
L2	1.40	--	1.78
V1	7° REF		
V2	0°	--	6°

**Package Outline Type-B**

DIM.	MILLIMETER		
	MIN.	NOM.	MAX.
A	2.10	2.30	2.40
A1	0	--	0.13
b	0.66	0.76	0.86
b3	5.21	5.38	5.55
c	0.40	0.50	0.60
c1	0.44	0.50	0.58
D	5.90	6.10	6.30
D1	5.30REF		
E	6.40	6.60	6.80
E1	4.63	-	-
e	2.29 BSC		
H	9.50	10.00	10.70
L	1.09	--	1.21
L2	1.35	--	1.65
V1	7° REF		
V2	0°	--	6°

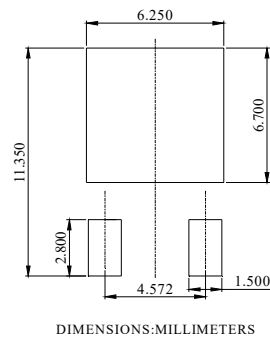
**Recommended Soldering Footprint**

单击下面可查看定价，库存，交付和生命周期等信息

[>>JW\(捷捷微\)](#)