

*Parameters Subject to Change Without Notice*

## DESCRIPTION

The JW1120 is a current mode monolithic buck LED driver. Operating with an input range of 4.5-20V, JW1120 delivers 2A of continuous output current with two integrated N-Channel MOSFETs. The internal synchronous power switches provide high efficiency without the use of an external Schottky diode. At light loads, the LED driver operates in low frequency to maintain high efficiency and low output ripple.

The JW1120 guarantees robustness with LED short protection, thermal protection, start-up current run-away protection, input under voltage lockout.

The JW1120 is available in 6-pin and 8-pin TSOT packages, which provide a compact solution with minimal external components.

*Company's Logo is Protected, "JW" and "JOULWATT" are Registered Trademarks of JoulWatt technology Inc.*

## FEATURES

- 4.5V to 20V operating input range
- 2A output current
- Up to 94% efficiency
- High efficiency (>85%) at light load
- Fixed 1MHz Switching frequency
- Input under voltage lockout
- Start-up current run-away protection
- LED short protection
- Thermal protection
- Available in TSOT23-6 and TSOT23-8 packages

## APPLICATIONS

- LED Driver

## TYPICAL APPLICATION

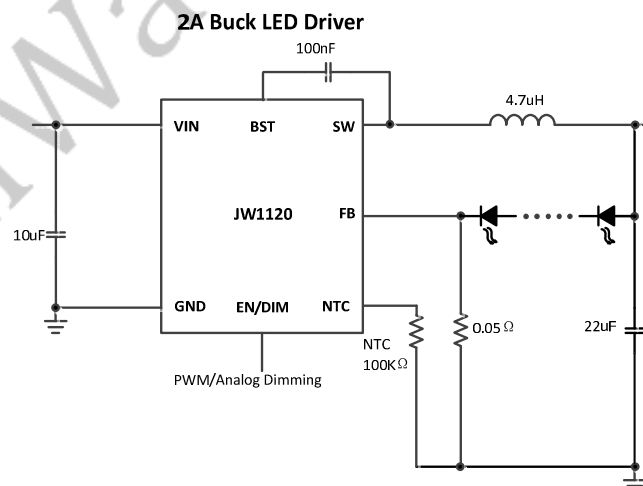

**ORDER INFORMATION**

LEAD FREE FINISH	TAPE AND REEL	PACKAGE	TOP MARKING
JW1120TSOTB#PBF	JW1120TSOTB#TRPBF	TSOT23-6	J20X
JW1120TSOTC#PBF	JW1120TSOTC#TRPBF	TSOT23-8	J21X

Note:

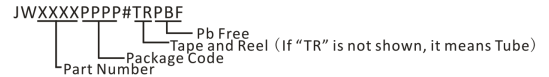

**PIN CONFIGURATION**

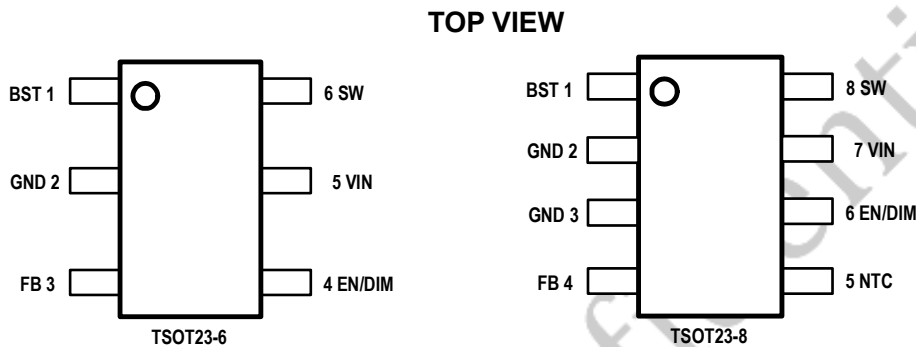

**ABSOLUTE MAXIMUM RATING<sup>1)</sup>**

VIN, SW Pin	-0.3V to 22V
BST Pin	SW-0.3V to SW+5V
All other pins	-0.3V to 6V
Junction Temperature <sup>(2) (3)</sup>	150°C
Lead Temperature	260°C
Storage Temperature	-65 °C to +150°C

**RECOMMENDED OPERATING CONDITIONS**

Input Voltage VIN	4.5V to 20V
Operating Junction Temperature	-40°C to 125°C

**THERMAL PERFORMANCE<sup>4)</sup>**

R <sub>θJC</sub> (°C/W)	R <sub>θJA</sub> (°C/W)	R <sub>θJB</sub> (°C/W)	ψ <sub>JT</sub> (°C/W)	ψ <sub>JB</sub> (°C/W)
55	110	14.7	1.2	14.7

Note:

- Exceeding these ratings may damage the device.
- The JW1120 guarantees robust performance from -40°C to 150°C junction temperature. The junction temperature range specification is assured by design, characterization and correlation with statistical process controls.
- The JW1120 includes thermal protection that is intended to protect the device in overload conditions. Thermal protection is active when junction temperature exceeds the maximum operating junction temperature. Continuous operation over the specified absolute maximum operating junction temperature may damage the device.
- Measured on JE51-7, 4-layer PCB.

**ELECTRICAL CHARACTERISTICS**

<i>V<sub>IN</sub>=12V, T<sub>A</sub>=25 °C, Unless otherwise stated</i>						
Item	Symbol	Conditions	Min.	Typ.	Max.	Unit
V <sub>IN</sub> Under Voltage Lock-out Threshold	V <sub>IN_MIN</sub>	V <sub>IN</sub> falling		3.8		V
V <sub>IN</sub> Under Voltage Lockout Hysteresis	V <sub>IN_MIN_HYST</sub>	V <sub>IN</sub> rising		320		mV
Shutdown Supply Current	I <sub>SD</sub>	V <sub>EN</sub> =0V			1	µA
Supply Current	I <sub>Q</sub>	V <sub>EN</sub> =5V, V <sub>FB</sub> =2V		100		µA
Feedback Voltage	V <sub>FB</sub>	4.5V<V <sub>IN</sub> <20V	95	100	105	mV
Top Switch Resistance <sup>5)</sup>	R <sub>DS(ON)T</sub>			100		mΩ
Bottom Switch Resistance <sup>5)</sup>	R <sub>DS(ON)B</sub>			100		mΩ
Top Switch Leakage Current	I <sub>LEAK_TOP</sub>	V <sub>IN</sub> =20V, V <sub>EN</sub> =0V, V <sub>SW</sub> =0V			1	µA
Bottom Switch Leakage Current	I <sub>LEAK_BOT</sub>	V <sub>IN</sub> =20V, V <sub>EN</sub> =0V, V <sub>SW</sub> =20V			1	µA
Top Switch Current Limit <sup>5)</sup>	I <sub>LIM_TOP</sub>	Minimum Duty Cycle		3.6		A
Switch Frequency	F <sub>SW</sub>			1		MHz
Minimum On Time <sup>5)</sup>	T <sub>ON_MIN</sub>			120		ns
Minimum Off Time <sup>5)</sup>	T <sub>OFF_MIN</sub>	V <sub>FB</sub> =0V		100		ns
Maximum Duty Cycle <sup>5)</sup>	D <sub>Max</sub>	V <sub>FB</sub> =0V		90		%
EN/DIM rising threshold	V <sub>ENH</sub>	V <sub>EN</sub> rising, FB=0V	1.2			V
EN/DIM falling threshold	V <sub>ENL</sub>	V <sub>EN</sub> falling, FB=0V			0.3	V
EN/DIM Input Low Voltage	V <sub>EN_PLOW</sub>	PWM dimming	0.285	0.3	0.315	V
EN/DIM Input High Voltage	V <sub>EN_PHIGH</sub>	PWM dimming	1.14	1.2	1.26	V
EN/DIM Analog Dimming High Threshold	V <sub>EN_AHIGH</sub>	Analog dimming	1.9	2	2.1	V
EN/DIM Analog Dimming Low Threshold	V <sub>EN_ALOW</sub>	Analog dimming	1.14	1.2	1.26	V
NTC Threshold	V <sub>NTC_HIGH</sub>		1.14	1.2	1.26	V
NTC Pull-up Current	I <sub>NTC</sub>		48	60	72	µA
Thermal Shutdown <sup>5)</sup>	T <sub>TSD</sub>			150		°C
Thermal Shutdown hysteresis <sup>5)</sup>	T <sub>TSD_HYST</sub>			15		°C

**Note:**

5) Guaranteed by design.

**PIN DESCRIPTION**

Pin (SOT23-8)	Pin (SOT23-6)	Name	Description
1	1	BST	Bootstrap pin for top switch. A 0.1uF or larger capacitor should be connected between this pin and the SW pin to supply current to the top switch and top switch driver.
2,3	2	GND	Ground.
4	3	FB	The FB pin is regulated at 0.1V. Depending on the resistance connected at the FB pin to ground, the maximum peak current is set.
5	NA	NTC	A constant current of 60uA is following out of this pin. Connect an NTC resistor at this pin for remote thermal sensing.
6	4	EN/DIM	Drive EN pin above 1.1V to enable the LED driver. To achieve dimming, drive the EN pin with a PWM pulse or an analog voltage between 1.2V and 2.0V.
7	5	VIN	Input voltage pin. VIN supplies power to the IC. Connect a 4.5V to 20V supply to VIN and bypass VIN to GND with a suitably large capacitor to eliminate noise on the input to the IC.
8	6	SW	SW is the switching node that supplies power to the output. Connect the output LC filter from SW to the output load.

**BLOCK DIAGRAM**

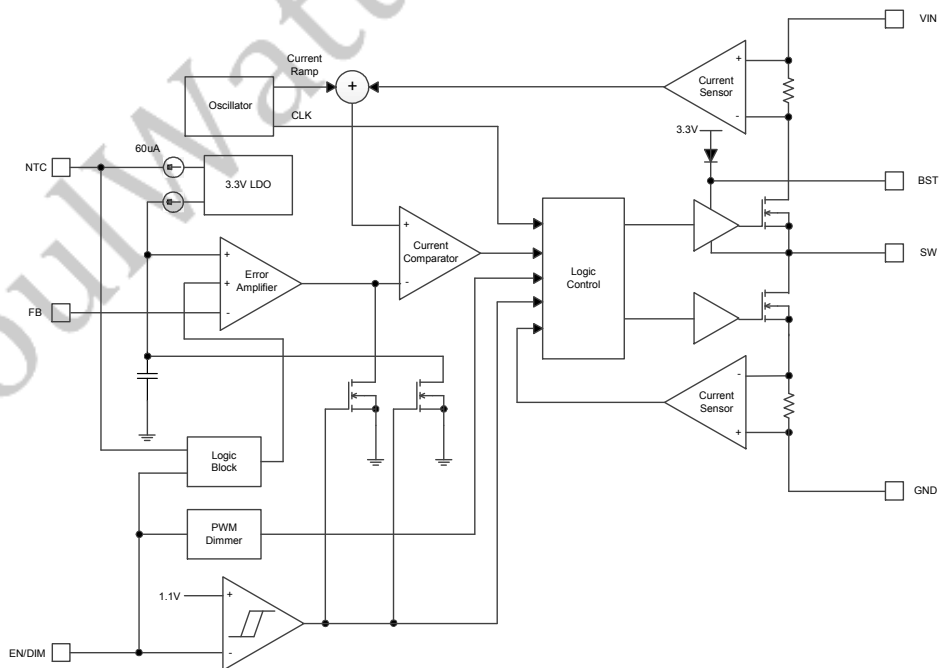

TYPICAL PERFORMANCE CHARACTERISTICS

Quiescent Current Vs. Temp

VIN=12V, VEN=3V, VFB=0.5V

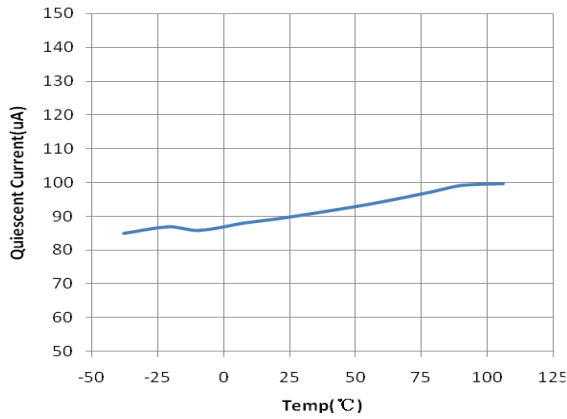

Quiescent Current Vs. Input Voltage

VEN=3V, VFB=0.5V

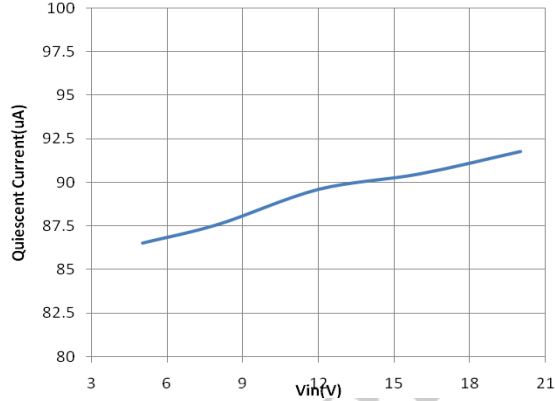

Feedback Voltage Vs. Temp.

VIN=12V, VEN=3V, Sweep FB voltage @ different temperature

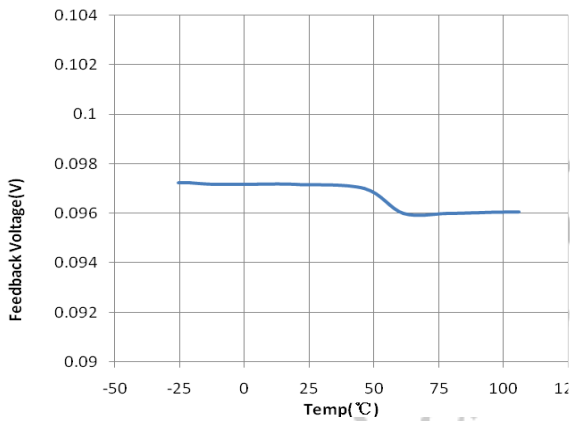

Efficiency vs. Vin

VEN=3V, Vout=4V, L=4.7uH

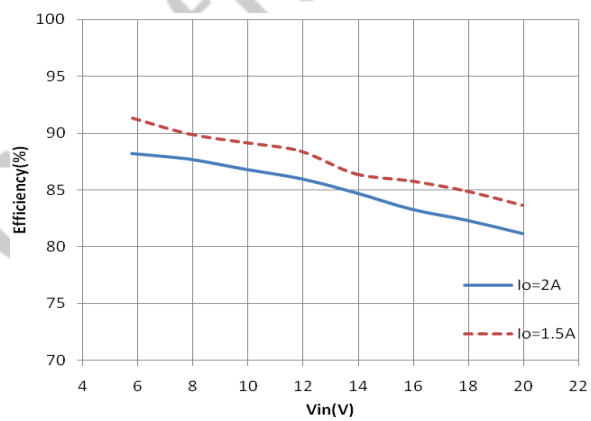

Efficiency vs. Vout

Io=500mA, L=4.7uH

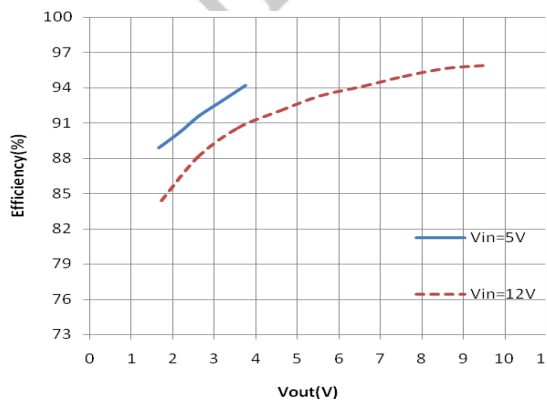

Line Regulation

VIN=12V, VEN=3V, Vout=4V, L=4.7uH

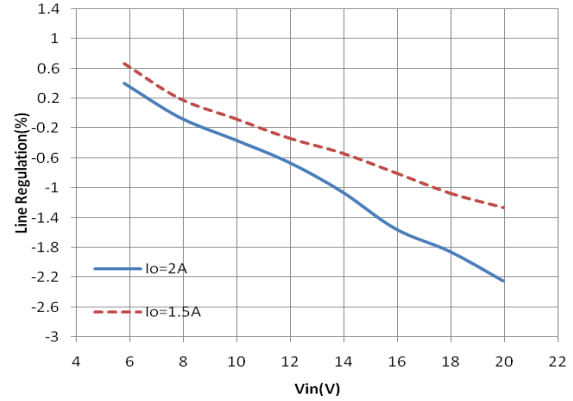

TYPICAL PERFORMANCE CHARACTERISTICS(continued)

**Analog Dimming**  
**I<sub>LED</sub> VS EN/DIM Voltage**  
VIN=12V, Vout=2#LED

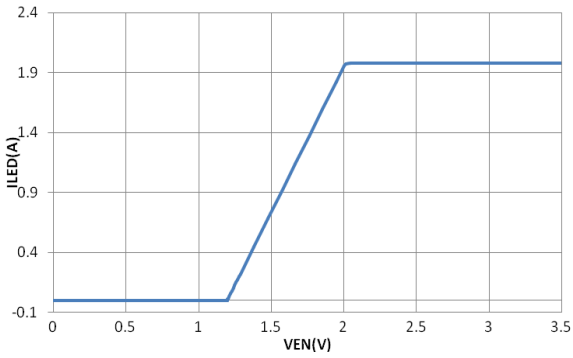

**PWM DIMMING**  
**Duty cycle VS Output Current**  
VIN=12V, Vout=2#LED  
PWM=1kHz

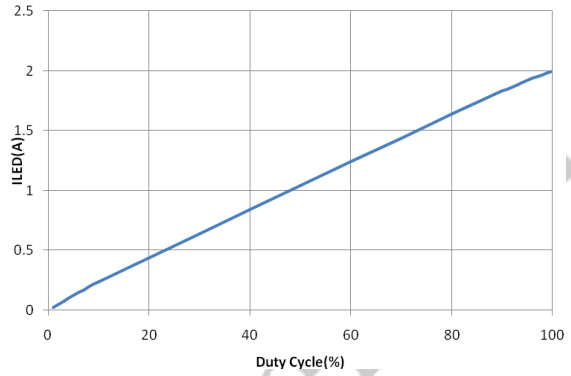

JoulWatt Confidential

**TYPICAL PERFORMANCE CHARACTERISTICS(continued)**

Vin =12V, Vout = 2#LED, L = 4.7μH, Cout = 22μF, TA = +25°C, unless otherwise noted

**Steady State Test**

VIN=12V, Vout=2#LED  
Iout=2A

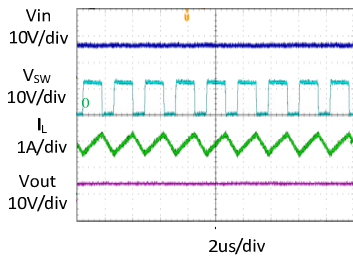

**Startup through Enable**

VIN=12V, Vout=2#LED  
Iout=2A

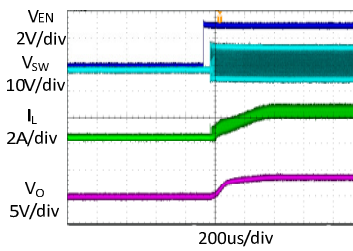

**Shutdown through Enable**

VIN=12V, Vout=2#LED  
Iout=2A

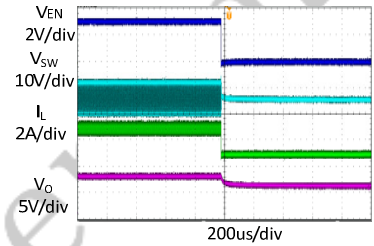

**Startup through Vin**

VIN=12V, Vout=2#LED  
Iout=2A

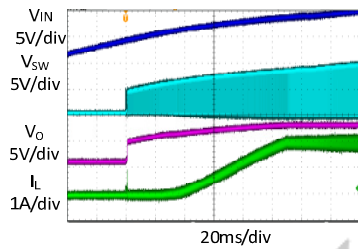

**Shutdown through Vin**

VIN=12V, Vout=2#LED  
Iout=2A

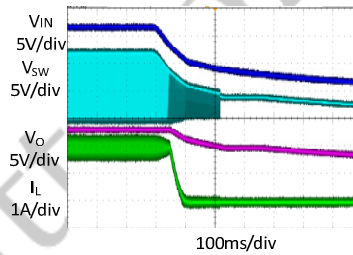

**Short LED+ to LED- Protection**

VIN=12V, Vout=2#LED  
Iout=2A- Short

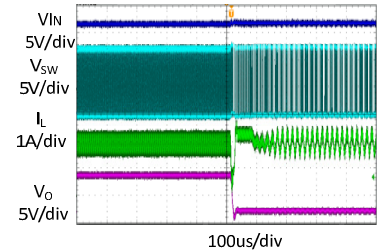

**Short LED+ to LED- Recovery**

VIN=12V, LED+ short to LED-,  
Recovery

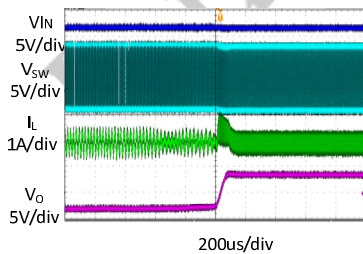

**Short LED+ to Gnd Protection**

VIN=12V, Vout=2#LED  
Iout=2A- Short

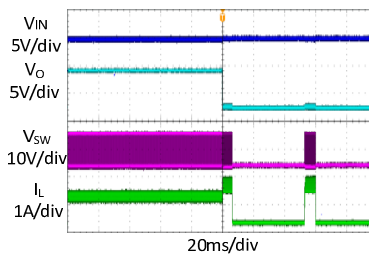

**Short LED+ to Gnd Recovery**

VIN=12V, LED+ short to Gnd-  
Recovery

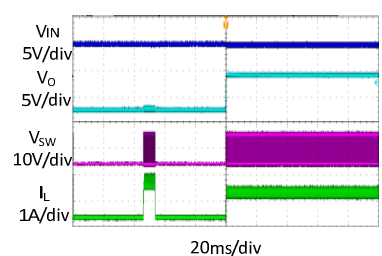

**TYPICAL PERFORMANCE CHARACTERISTICS** *(continued)*

Vin =12V, Vout = 2#LED, L = 4.7μH, Cout = 22μF, TA = +25°C, unless otherwise noted

**Open LED Load Protection**

VIN=12V, Vout=2#LED  
Iout=2A- open

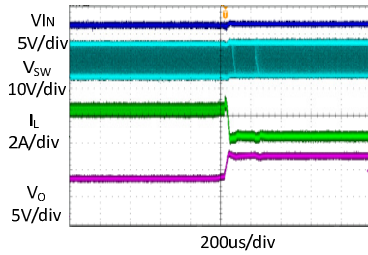

**Open LED Load Recovery**

VIN=12V, Vout=2#LED  
Iout=2A

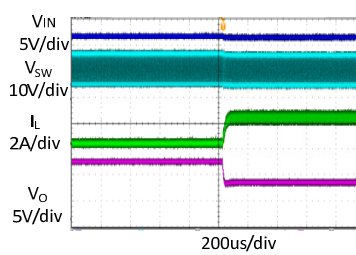

**PWM Dimming**

VIN=12V, Vout=2#LED  
PWM=1kHz, 50%

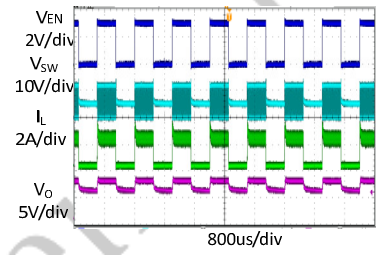

**PWM Dimming**

VIN=12V, Vout=2#LED  
PWM=1kHz, 1%

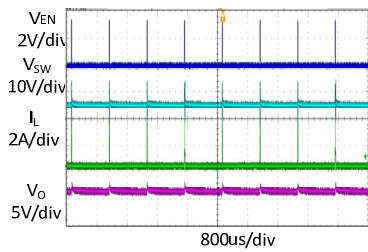

**PWM Dimming**

VIN=12V, Vout=2#LED  
PWM=1kHz, 99%

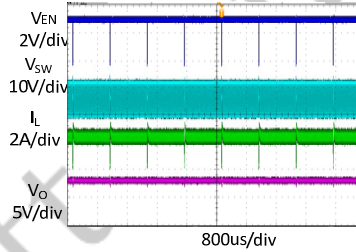



## FUNCTIONAL DESCRIPTION

The JW1120 is a synchronous, current-mode buck LED driver capable of supplying up to 2A of load current.

### Current-Mode Control

The JW1120 utilizes current-mode control to regulate the FB voltage. Voltage at the FB pin is regulated at 0.1V so that by connecting a resistor at the FB pin to ground, maximum current through the LED string can be accurately controlled.

### PFM Mode

The JW1120 operates in PFM mode at light load. In PFM mode, switch frequency is continuously controlled in proportion to the load current, i.e. switch frequency decreases when load current drops to boost power efficiency at light load by reducing switch-loss, while switch frequency increases when load current rises, minimizing both load current and output voltage ripples.

### Shut-Down Mode

The JW1120 operates in shut-down mode when voltage at EN pin is driven below 0.3V. In shut-down mode, the entire regulator is off and the supply current consumed by the JW1120 drops below 1 $\mu$ A.

### PWM Dimming

Current through the LED string can be controlled by applying PWM signal at the EN/DIM pin. The LED current rises and falls in proportion to the duty cycle of the applied PWM pulses.

### Analog Dimming

Besides PWM dimming, current through the

LED string can also be controlled by applying an analog voltage at the EN/DIM pin. Voltage below 1.2V leads to very small LED current, while voltage above 2V corresponds to full LED current. In between 1.2V and 2V, the LED current changes proportionally to the EN/DIM voltage.

### Power Switch

N-Channel MOSFET switches are integrated on the JW1120 to down convert the input voltage to the regulated output voltage. Since the top MOSFET needs a gate voltage great than the input voltage, a boost capacitor connected between BST and SW pins is required to drive the gate of the top switch. The boost capacitor is charged by the internal 3.3V rail when SW is low.

### Vin Under-Voltage Protection

A resistive divider can be connected between Vin and ground, with the central tap connected to EN, so that when Vin drops to the pre-set value, EN drops below 1.2V to trigger input under voltage lockout protection.

### Output Current Run-Away Protection

At start-up, due to the high voltage at input and low voltage at output, current inertia of the output inductor can be easily built up, resulting in a large start-up output current. A valley current limit is designed in the JW1120 so that only when output current drops below the valley current limit can the bottom power switch be turned off. By such control mechanism, the output current at start-up is well controlled.

### LED Short Protection

When the positive terminal of the LED string

(the output of the LED driver) is short to ground, LED short protection is activated. In LED short protection mode, the LED driver switches for 10ms to try to bring the voltage at the positive terminal of the LED string up and if it fails to bring the voltage up, then the LED driver will stop switching for 44ms to allow heat to be dissipated. This hiccup cycle will continue until the short condition is removed.

### **Thermal Protection**

When the temperature of the JW1120 rises above 150°C, it is forced into thermal shut-down.

Only when core temperature drops below 135°C can the regulator become active again.

### **Remote Thermal Sensing**

A constant current of 60uA is flowing out of the NTC pin. An NTC resistor is to be connected at this pin so that the pin voltage is above 1.2V during normal operation. When the sensed LED temperature rises, voltage at the NTC pin falls and when it falls below 1.2V, the allowed maximum LED current falls to protect the LED strings.

JoulWatt Confidential

## APPLICATION INFORMATION

### LED Current Set

The output current is determined by the resistor  $R_{sense}$  connected between LED+ and LED-, and the output current can be calculated by:

$$R_{sense} = \frac{100mV}{I_{LED}}$$

For example, for  $I_{LED} = 2A$ ,  $R_{sense}=50m\Omega$ .

### PWM Dimming

A PWM pulse can also be applied to the EN/DIM pin to achieve dimming. When PWM dimming, the LED current is proportional to the duty cycle of the PWM square pulse.

### Analog Dimming

The analogy dimming range is 1.2V to 2.0V corresponding to the LED current sense voltage of 0V ~ 100mV. Refer to the dimming curve.

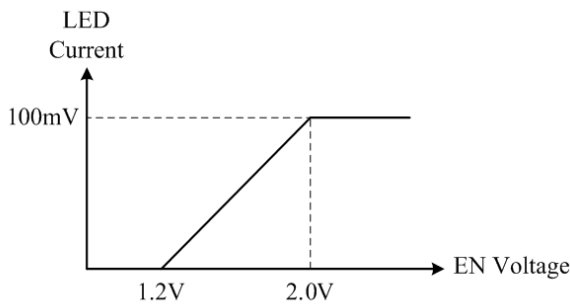

### Input Capacitor

The input capacitor is used to supply the AC input current to the step-down converter and maintaining the DC input voltage. The ripple current through the input capacitor can be calculated by:

$$I_{C1} = I_{LOAD} \cdot \sqrt{\frac{V_{OUT}}{V_{IN}} \cdot \left(1 - \frac{V_{OUT}}{V_{IN}}\right)}$$

where  $I_{LOAD}$  is the load current,  $V_{OUT}$  is the output voltage,  $V_{IN}$  is the input voltage.

Thus the input capacitor can be calculated by the following equation when the input ripple voltage is determined.

$$C_1 = \frac{I_{LOAD}}{f_s \cdot \Delta V_{IN}} \cdot \frac{V_{OUT}}{V_{IN}} \cdot \left(1 - \frac{V_{OUT}}{V_{IN}}\right)$$

where  $C_1$  is the input capacitance value,  $f_s$  is the switching frequency,  $\Delta V_{IN}$  is the input ripple current.

The input capacitor is used to reduce the surge current from the input supply and maintaining the DC input voltage. It can be electrolytic, tantalum or ceramic. To minimizing the switching noise, a small X5R or X7R ceramic capacitor, i.e. 0.1uF, should be placed as close to the IC as possible when using electrolytic capacitors. A 10uF ceramic capacitor is sufficient for most application.

### Output Capacitor

The output capacitor is required to maintain the DC output voltage, and the capacitance value determines the output ripple voltage. It can be low ESR electrolytic, tantalum or ceramic, which lower ESR capacitors get lower output ripple voltage.

The output capacitors also affect the system stability and transient response, and a 2.2uF ceramic capacitor and a 47uF electrolytic capacitor are recommended in typical application.

### Inductor

The inductor is used to supply constant current to the output load, and the value determines the ripple current which affect the efficiency and the

output voltage ripple. The ripple current is typically allowed to be 30% of the maximum switch current limit, thus the inductance value can be calculated by:

$$L = \frac{V_{OUT}}{f_s \cdot \Delta I_L} \cdot \left(1 - \frac{V_{OUT}}{V_{IN}}\right)$$

where  $V_{IN}$  is the input voltage,  $V_{OUT}$  is the output voltage,  $f_s$  is the switching frequency, and  $\Delta I_L$  is the peak-to-peak inductor ripple current.

**PCB Layout Precaution**

The PCB layout of JW1120 must be carefully designed. Different PCB layout optimization is required for different topology application of

JW1120.

1. Place the input decoupling capacitor as close to JW1120 ( $V_{IN}$  pin and GND) as possible to eliminate noise at the input pin. The loop area formed by input capacitor and GND must be minimized.
2. Put the feedback trace as far away from the inductor and noisy power traces as possible.
3. The ground plane on the PCB should be as large as possible for better heat dissipation

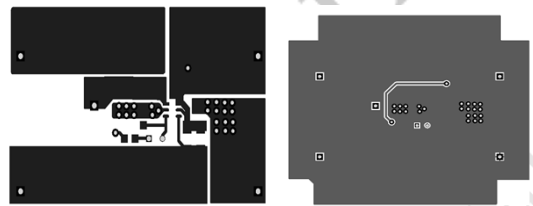

PACKAGE OUTLINE

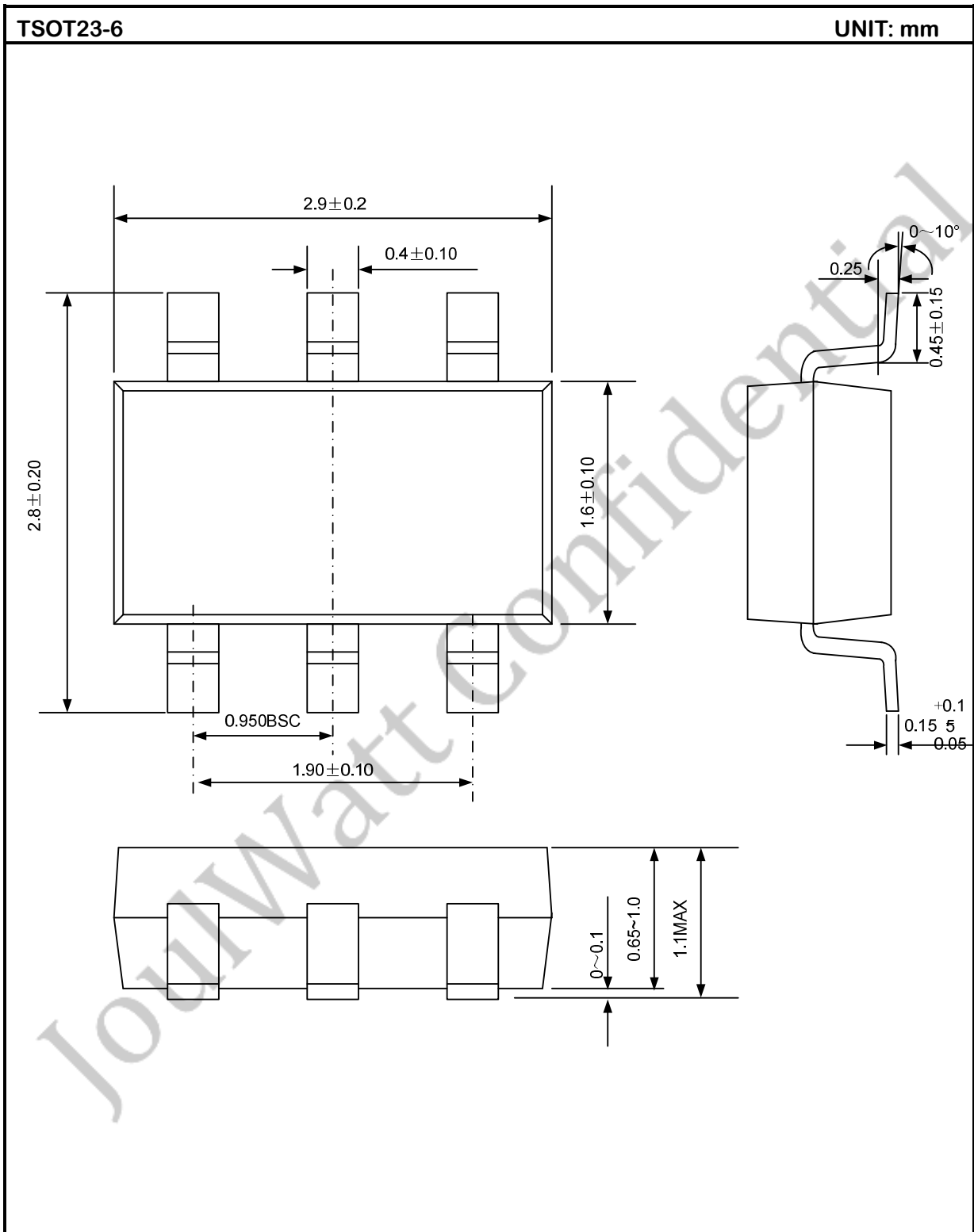

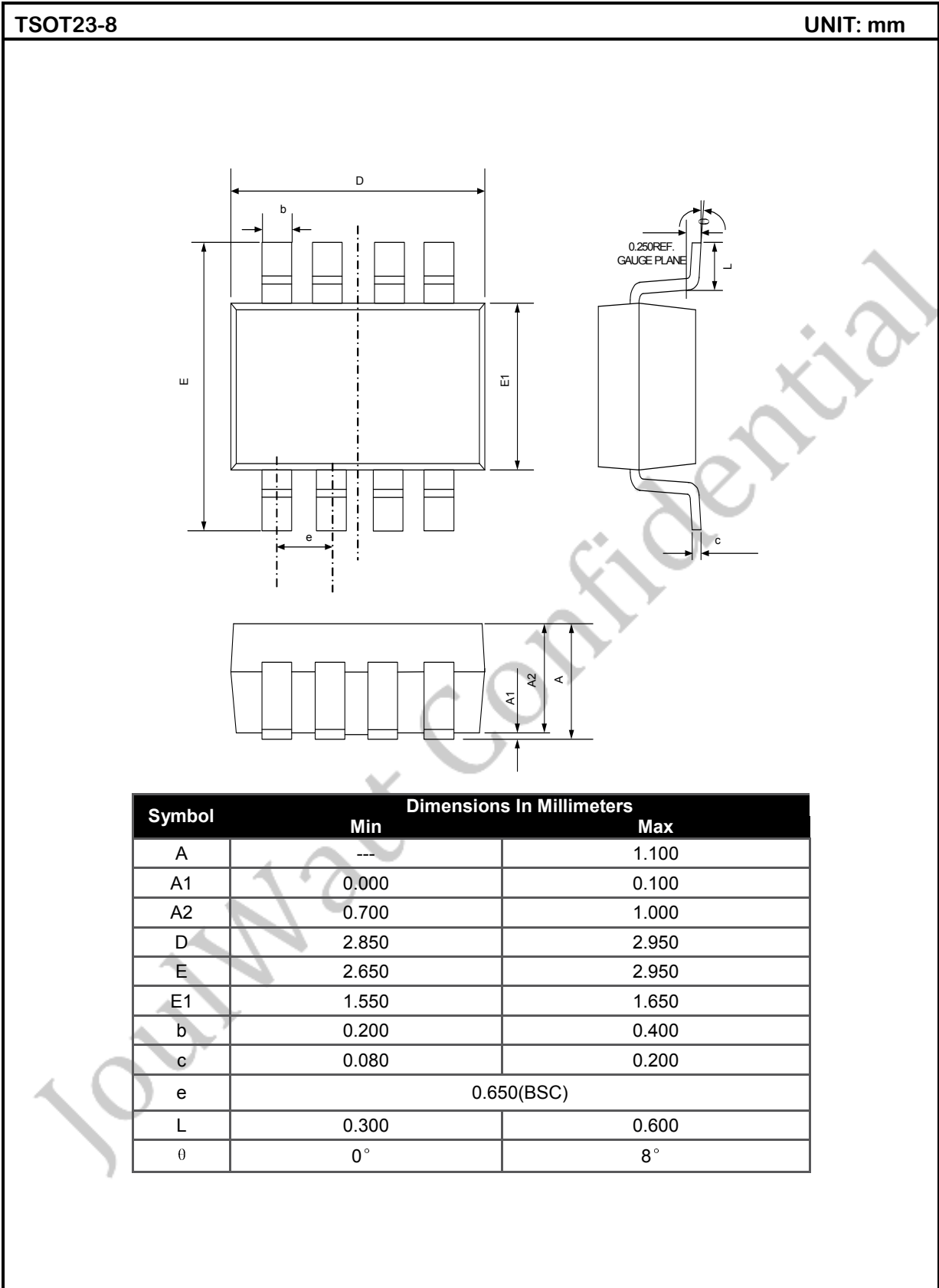

**IMPORTANT NOTICE**

- Joulwatt Technology Inc. reserves the right to make modifications, enhancements, improvements, corrections or other changes without further notice to this document and any product described herein.
- Any unauthorized redistribution or copy of this document for any purpose is strictly forbidden.
- Joulwatt Technology Inc. does not warrant or accept any liability whatsoever in respect of any products purchased through unauthorized sales channel.

JoulWatt Confidential

*Copyright © 2015 JW1120 Incorporated.*

*All rights are reserved by Joulwatt Technology Inc.*

单击下面可查看定价，库存，交付和生命周期等信息

[>>JOULWATT\(杰华特\)](#)