

## SOD-323 Plastic-Encapsulate Diodes

### B5817WS-5819WS SCHOTTKY BARRIER DIODE

#### FEATURES

For use in low voltage, high frequency inverters  
Free wheeling, and polarity protection applications

#### MARKING:

B5817WS:SJ	B5818WS:SK	B5819WS:SL

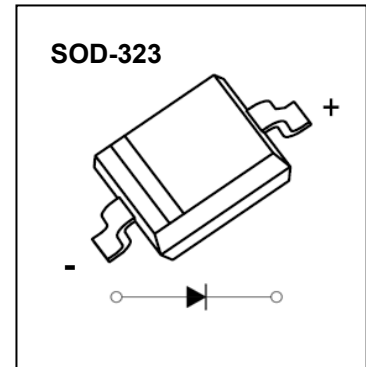

The marking bar indicates the cathode  
Solid dot = Green molding compound device, if none, the normal device.

#### Maximum Ratings and Electrical Characteristics, Single Diode @Ta=25°C

Parameter	Symbol	B5817WS	B5818WS	B5819WS	Unit
Non-repetitive peak reverse voltage	$V_{RM}$	20	30	40	V
Peak repetitive peak reverse voltage	$V_{RRM}$	20	30	40	V
Working peak reverse voltage	$V_{RWM}$				
DC blocking voltage	$V_R$				
RMS reverse voltage	$V_{R(RMS)}$	14	21	28	V
Average rectified output current	$I_O$	1			A
Non-repetitive Peak Forward Surge Current @t=8.3ms	$I_{FSM}$	9			A
Repetitive peak forward current	$I_{FRM}$	1.5			A
Power dissipation	$P_d$	250			mW
Thermal resistance junction to ambient	$R_{\theta JA}$	400			°C/W
Junction temperature	$T_J$	125			°C
Storage temperature	$T_{STG}$	-55~+150			°C

#### ELECTRICAL CHARACTERISTICS (Ta=25°C unless otherwise specified)

Parameter	Symbol	Test conditions	Min	Max	Unit		
Reverse breakdown voltage	$V_{(BR)}$	$I_R=1mA$ B5817WS B5818WS B5819WS	20 30 40		V		
Reverse voltage leakage current	$I_R$	$V_R=20V$ $V_R=30V$ $V_R=40V$ B5817WS B5818WS B5819WS		1	mA		
Forward voltage	$V_F$	B5817WS	$I_F=1A$ $I_F=3A$	0.45 0.75	V		
		B5818WS	$I_F=1A$ $I_F=3A$	0.55 0.875	V		
			B5819WS	$I_F=1A$ $I_F=3A$	0.6 0.9	V	
		Diode capacitance		$C_D$	$V_R=4V, f=1MHz$		120

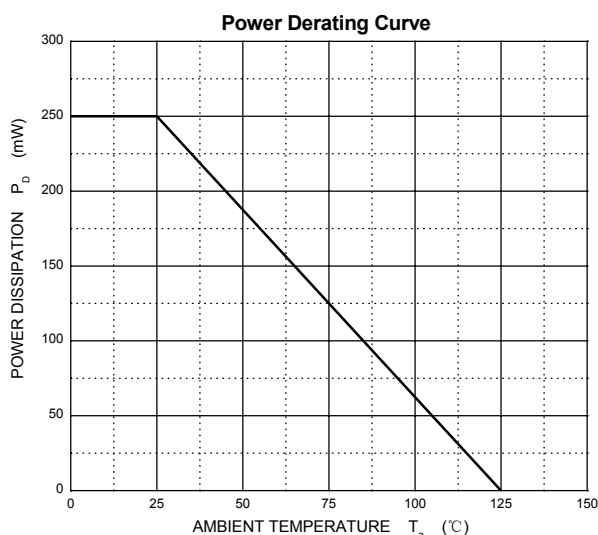
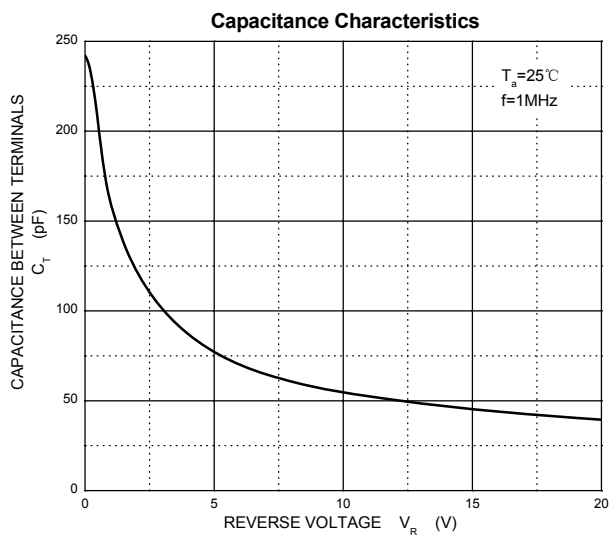
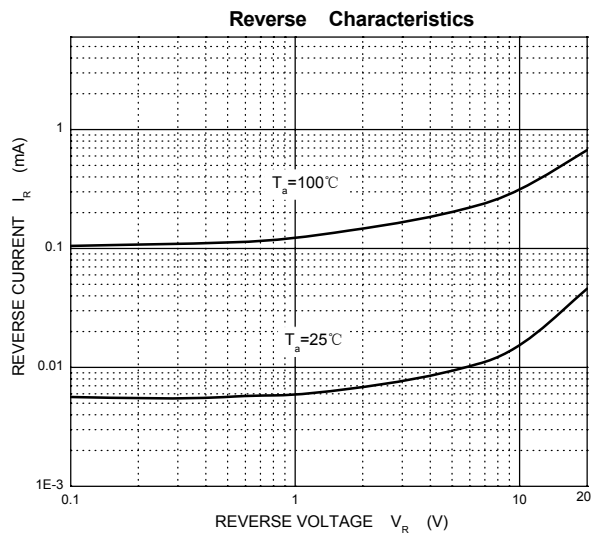
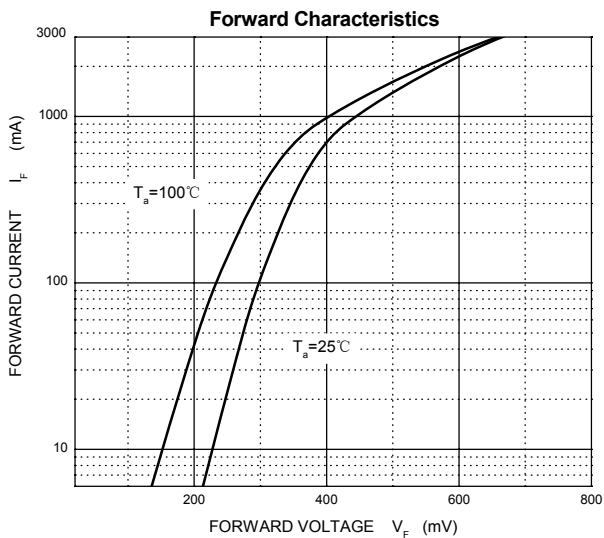

## SOD-323 Package Outline Dimensions

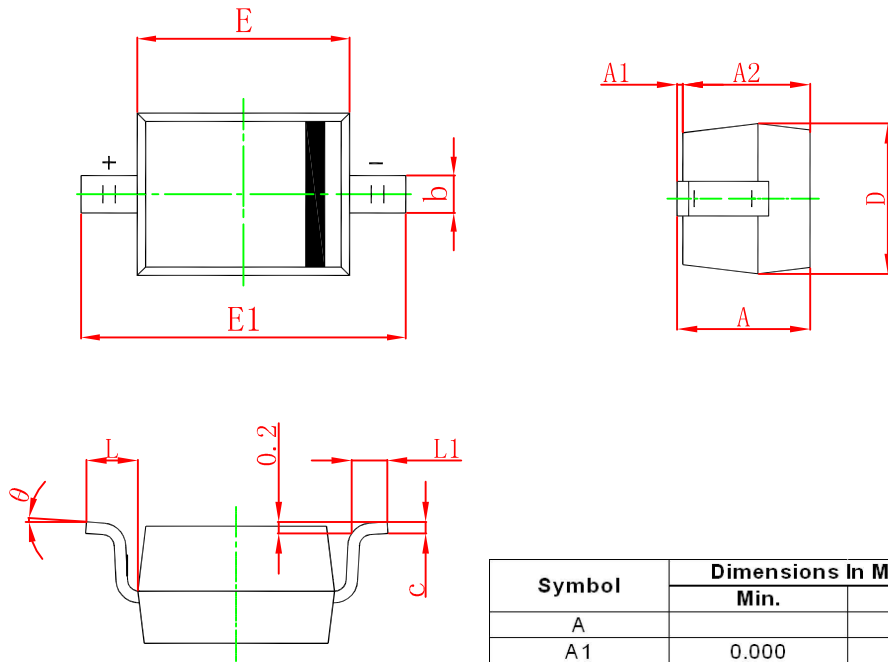

Symbol	Dimensions In Millimeters		Dimensions In Inches	
	Min.	Max.	Min.	Max.
A		1.000		0.039
A1	0.000	0.100	0.000	0.004
A2	0.800	0.900	0.031	0.035
b	0.250	0.350	0.010	0.014
c	0.080	0.150	0.003	0.006
D	1.200	1.400	0.047	0.055
E	1.600	1.800	0.063	0.071
E1	2.550	2.750	0.100	0.108
L	0.475 REF.		0.019 REF.	
L1	0.250	0.400	0.010	0.016
θ	0°	8°	0°	8°

## SOD-323 Suggested Pad Layout

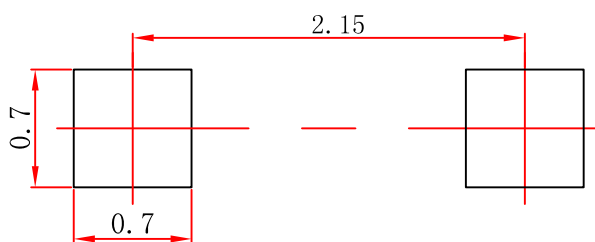

### Note:

1. Controlling dimension: in millimeters.
2. General tolerance:  $\pm 0.05\text{mm}$ .
3. The pad layout is for reference purposes only.

### NOTICE

JSCJ reserves the right to make modifications, enhancements, improvements, corrections or other changes without further notice to any product herein. JSCJ does not assume any liability arising out of the application or use of any product described herein.

# SOD-323 Tape and Reel

## SOD-323 Embossed Carrier Tape

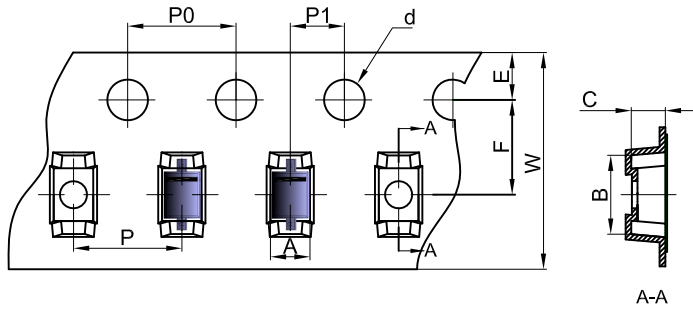

### Packaging Description:

SOD-323 parts are shipped in tape. The carrier tape is made from a dissipative (carbon filled) polycarbonate resin. The cover tape is a multilayer film (Heat Activated Adhesive in nature) primarily composed of polyester film, adhesive layer, sealant, and anti-static sprayed agent. These reeled parts in standard option are shipped with 3,000 units per 7" or 17.8cm diameter reel. The reels are clear in color and is made of polystyrene plastic (anti-static coated).

Dimensions are in millimeter										
Pkg type	A	B	C	d	E	F	P0	P	P1	W
SOD-323	1.48	3.3	1.25	Ø1.50	1.75	3.50	4.00	4.00	2.00	8.00

## SOD-323 Tape Leader and Trailer

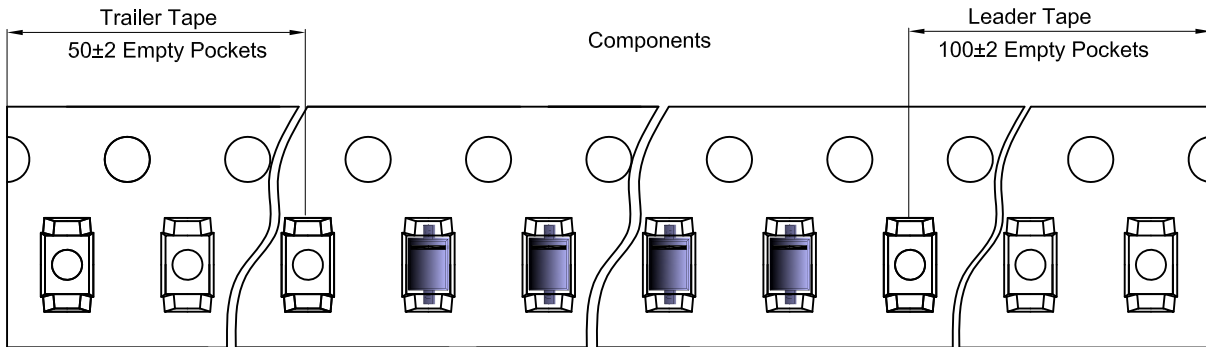

## SOD-323 Reel

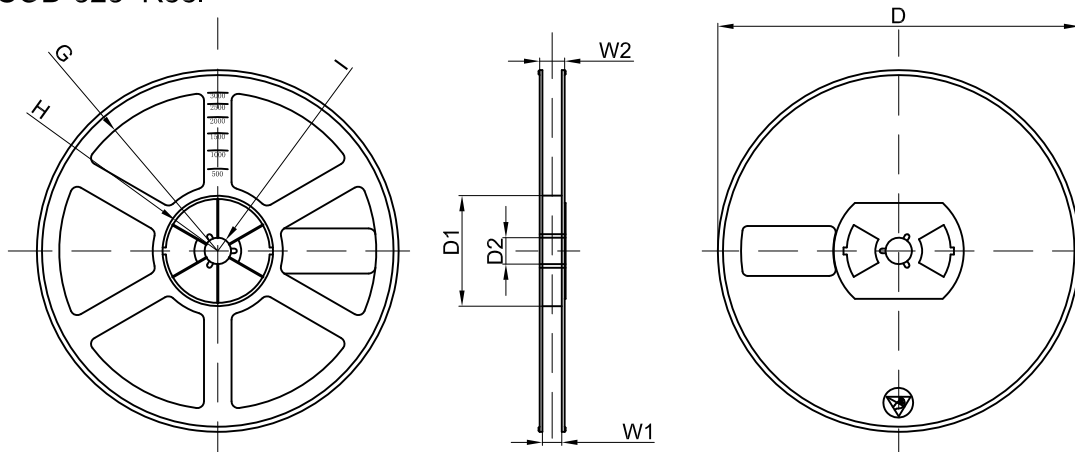

Dimensions are in millimeter								
Reel Option	D	D1	D2	G	H	I	W1	W2
7" Dia	Ø178.00	54.40	13.00	R78.00	R25.60	R6.50	9.50	12.30

REEL	Reel Size	Box	Box Size(mm)	Carton	Carton Size(mm)	G.W.(kg)
3000 pcs	7 inch	45,000 pcs	203×203×195	180,000 pcs	438×438×220	

单击下面可查看定价，库存，交付和生命周期等信息

[>>JSCJ](#)